

Pressure-relieving and Depressuring Systems

API STANDARD 521
SEVENTH EDITION, JUNE 2020



AMERICAN PETROLEUM INSTITUTE

Special Notes

API publications necessarily address problems of a general nature. With respect to particular circumstances, local, state, and federal laws and regulations should be reviewed.

Neither API nor any of API's employees, subcontractors, consultants, committees, or other assignees make any warranty or representation, either express or implied, with respect to the accuracy, completeness, or usefulness of the information contained herein, or assume any liability or responsibility for any use, or the results of such use, of any information or process disclosed in this publication. Neither API nor any of API's employees, subcontractors, consultants, or other assignees represent that use of this publication would not infringe upon privately owned rights.

API publications may be used by anyone desiring to do so. Every effort has been made by the Institute to ensure the accuracy and reliability of the data contained in them; however, the Institute makes no representation, warranty, or guarantee in connection with this publication and hereby expressly disclaims any liability or responsibility for loss or damage resulting from its use or for the violation of any authorities having jurisdiction with which this publication may conflict.

API publications are published to facilitate the broad availability of proven, sound engineering and operating practices. These publications are not intended to obviate the need for applying sound engineering judgment regarding when and where these publications should be utilized. The formulation and publication of API publications is not intended in any way to inhibit anyone from using any other practices.

Any manufacturer marking equipment or materials in conformance with the marking requirements of an API standard is solely responsible for complying with all the applicable requirements of that standard. API does not represent, warrant, or guarantee that such products do in fact conform to the applicable API standard.

All rights reserved. No part of this work may be reproduced, translated, stored in a retrieval system, or transmitted by any means, electronic, mechanical, photocopying, recording, or otherwise, without prior written permission from the publisher. Contact the publisher, API Publishing Services, 200 Massachusetts Avenue, Suite 1100, Washington, DC.

Copyright © 2020 American Petroleum Institute

Foreword

Nothing contained in any API publication is to be construed as granting any right, by implication or otherwise, for the manufacture, sale, or use of any method, apparatus, or product covered by letters patent. Neither should anything contained in the publication be construed as insuring anyone against liability for infringement of letters patent.

The verbal forms used to express the provisions in this document are as follows.

Shall: As used in a standard, “shall” denotes a minimum requirement in order to conform to the standard.

Should: As used in a standard, “should” denotes a recommendation or that which is advised but not required in order to conform to the standard.

May: As used in a standard, “may” denotes a course of action permissible within the limits of a standard.

Can: As used in a standard, “can” denotes a statement of possibility or capability.

This document was produced under API standardization procedures that ensure appropriate notification and participation in the developmental process and is designated as an API standard. Questions concerning the interpretation of the content of this publication or comments and questions concerning the procedures under which this publication was developed should be directed in writing to the Director of Standards, American Petroleum Institute, 200 Massachusetts Avenue, Suite 1100, Washington, DC 20001. Requests for permission to reproduce or translate all or any part of the material published herein should also be addressed to the director.

Generally, API standards are reviewed and revised, reaffirmed, or withdrawn at least every five years. A one-time extension of up to two years may be added to this review cycle. Status of the publication can be ascertained from the API Standards Department, telephone (202) 682-8000. A catalog of API publications and materials is published annually by API, 200 Massachusetts Avenue, Suite 1100, Washington, DC 20001.

Suggested revisions are invited and should be submitted to the Standards Department, API, 200 Massachusetts Avenue, Suite 1100, Washington, DC 20001, standards@api.org.

Contents

	Page
1	Scope 1
2	Normative References 1
3	Terms, Definitions, Acronyms, and Abbreviations 1
3.1	Terms and Definitions 1
3.2	Acronyms and Abbreviations 10
4	Causes of Overpressure and Their Relieving Rates 11
4.1	General 11
4.2	Overpressure Protection Philosophy 12
4.3	Determination of Individual Relieving Rates 14
4.4	Individual Overpressure Causes and Their Relieving Rates 16
4.5	Guidance on Vacuum Relief 64
4.6	Vapor Depressuring 66
4.7	Relief System Design Documentation 74
4.8	Flare Header Design Documentation 78
4.9	Special Considerations for Individual PRDs 78
5	Disposal Systems 80
5.1	General 80
5.2	Fluid Properties That Influence Selection and Design of Disposal Systems 80
5.3	System Design Load 82
5.4	System Arrangement 85
5.5	Piping 88
5.6	Disposal to a Lower-pressure System 104
5.7	Disposal to Flare 104
5.8	Disposal to Atmosphere 125
5.9	Design Details for Seal and Knockout Drums 142
	Annex A (informative) An Analytical Methodology for Fire Evaluations 144
	Annex B (informative) Special System Design Considerations 162
	Annex C (informative) Sample Calculations 165
	Annex D (informative) Typical Details and Sketches 204
	Annex E (informative) High-integrity Protection Systems 207
	Annex F (informative) Flare Background Information 213
	Annex G (informative) Vapor Breakthrough into Liquid-containing Systems 219
	Annex H (informative) Flow-induced Vibration 222
	Bibliography 223
Figures	
1	Average Rate of Heating Steel Plates Exposed to Open Gasoline Fire on One Side 40
2	Effect of Overheating Carbon Steel (ASTM A515, Grade 70) 41
3	Isothermal Flow Chart 91
4	Adiabatic Flow of $k = 1.00$ (i.e. Isothermal Flow) Compressible Fluids Through Pipes at High Pressure Drops 93
5	Determination of Drag Coefficient 117

Contents

	Page	
6	Typical Flare Gas Recovery System	122
7	Flare Gas Recovery Inlet Pressure	124
8	Maximum Downwind Vertical Distance from Jet Exit to Lean-flammability Concentration Limit for Petroleum Gases	128
9	Maximum Downwind Horizontal Distance from Jet Exit to Lean-flammability Concentration Limit for Petroleum Gases	129
10	Axial Distance to Lean- and Rich-flammability Concentration Limits for Petroleum Gases	130
11	Sound Pressure Level at 30 m (100 ft) from the Stack Tip	141
A.1	Effect of Fuel Air Stoichiometry on Pool and Jet Fire Heat Fluxes	144
A.2	Typical Effect of Wall Temperature on Absorbed Heat Flux for Pool Fires	147
A.3	Illustration of Actual Stress Compared with the UTS for a Fire Exposed Pipe That Is Depressurized	154
A.4	Fire Depressurization Work Flow Diagram	155
A.5	Minimum Depressuring Rates to Avoid Failure of a Gas-filled Vessel Fabricated from SA-516 Carbon Steel and Exposed to a Pool Fire	159
A.6	Vapor Pressure and Heat of Vaporization of Pure, Single-component Paraffin Hydrocarbon Liquids	161
B.1	Typical Flow Scheme of a System Involving a Single PRD Serving Components in a Process System with Typical Pressure Profiles	163
C.1	Equilibrium Phase Diagram for a Given Liquid	166
C.2	Dimensional References for Sizing a Flare Stack	171
C.3	Flame Center for Flares and Ignited Vents—Horizontal Distance, x_c (SI Units)	176
C.4	Flame Center for Flares and Ignited Vents—Horizontal Distance, x_c (USC Units)	177
C.5	Flame Center for Flares and Ignited Vents—Vertical Distance, y_c (SI Units)	178
C.6	Flame Center for Flares and Ignited Vents—Vertical Distance, y_c (USC Units)	179
C.7	Flare Knockout Drum	182
C.8	Use of the Analytical Method to Reproduce API Fire Test Data (See Plate 2 of Figure 1)	190
C.9	Use of the Analytical Method to Reproduce API Figure 1, Plates 1, 3, and 4	191
C.10	BRL Test Data Illustrating Fire Temperature vs Time at the Top of the Front and Rear Walls of a Rail Tank Car Containing LPG and Exposed to a JP-4 Pool Fire	192
C.11	BRL Test Data Illustrating Wall Temperature vs Time at the Top of the Front and Rear Walls of a Rail Tank Car Containing LPG and Exposed to a JP-4 Pool Fire	192
C.12	Use of the Analytical Method to Reproduce BRL Fire Test Data (Constant Fire Temperature)	193
C.13	BAM Test Data Illustrating Fire Temperature vs Time at Various Locations Around a Rail Tank Car Containing LPG and Exposed to a Fuel Oil Pool Fire	194
C.14	BAM Test Data Illustrating Wall Temperature vs Time at Various Locations Around a Rail Tank Car Containing LPG and Exposed to a Fuel Oil Pool Fire	195
C.15	Use of the Analytical Method to Reproduce BAM Fire Test Data (Variable Fire Temperature)	196
C.16	Use of the Analytical Method to Reproduce BAM Fire Test Data (Constant Fire Temperature)	197
C.17	Liquid Temperature vs Time Profile from the BAM Fire Test	199
C.18	Comparison of the API Empirical Method and the Analytical Method with BRL Fire Test Data	201
C.19	Calculated Wetted Area Exponent of the API Empirical Method Equation (8) Based on BRL Fire Test Data	201
D.1	Typical Horizontal Flare Seal Drum	204
D.2	Quench Drum	205
D.3	Typical Flare Installation	206
F.1	Flame Length vs Heat Release—Industrial Sizes and Releases (SI Units)	216
F.2	Flame Length vs Heat Release—Industrial Sizes and Releases (USC Units)	217
F.3	Approximate Flame Distortion Due to Lateral Wind on Jet Velocity from Flare Stack	218

Contents

Page

Tables

1	Guidance for Required Relieving Rates Under Selected Conditions	17
2	Typical Values of Cubic Expansion Coefficient for Hydrocarbon Liquids and Water.	33
3	Values of Linear Expansion Coefficient, α_l , and Modulus of Elasticity, E	36
4	Effects of Fire on the Wetted Surfaces of a Vessel	39
5	Environmental Factor	42
6	Thermal Conductivity Values for Typical Thermal Insulations	50
7	Possible Utility Failures and Equipment Affected	62
8	Design Basis for PRD Laterals and Disposal System Headers	85
9	Typical K -factors for Pipe Fittings	94
10	Typical K -factors for Reducers (Contraction or Enlargement).	95
11	Exposure Times Necessary to Reach the Pain Threshold	106
12	Recommended Design Thermal Radiation for Personnel	106
A.1	Comparison of Heat Absorption Rates in Fire Tests.	146
A.2	Typical Range in Equation (A.1) Parameters for an Open Pool Fire	149
A.3	Recommended Values for Equation (A.1) Parameters for an Open Pool Fire Where Other Data or Information is Unavailable	150
A.4	Typical Range in Equation (A.1) Parameters for a Jet Fire.	151
A.5	Recommended Values for Equation (A.1) Parameters for a Jet Fire Where Other Data or Information Is Unavailable	152
A.6	Typical Starting Points for Step 1 in Figure A.4 When Designing Depressurization System for Unwetted Walls Exposed to Jet Fires	156
A.7	High-temperature Tensile Strength of Carbon Steel and 18-8 Stainless Steel	159
C.1	Optimizing the Size of a Horizontal Knockout Drum (SI Units)	185
C.2	Optimizing the Size of a Horizontal Knockout Drum (USC Units)	186
C.3	Equation (A.1) Parameters Used to Reproduce Curves in Figure 1	190
C.4	Equation (A.1) Parameters Used to Reproduce BRL Fire Test Data for the Rail Tank Car Top Front and Rear Wall Temperatures vs Time	193
C.5	Equation (A.1) Parameters Used to Reproduce BAM Fire Test Data for the Rear Locations of the Rail Tank Car Temperatures vs Time	195
C.6	Comparison of Absorbed Heat Duties Calculated with the API Empirical and Analytical Method Applying the BAM Fire Test Data	198
E.1	Safety Integrity Level vs Availability	210
F.1	Radiation from Gaseous Diffusion Flames	215

Introduction

The portions of this standard dealing with flares and flare systems are an adjunct to API Standard 537, which addresses design, operation, and maintenance of flare equipment. It is important for all parties involved in the design and use of a flare system to have an effective means of communicating and preserving design information about the flare system. To this end, API has developed a set of flare datasheets, which can be found in API Standard 537, Annex E. The use of these datasheets is both recommended and encouraged as a concise, uniform means of recording and communicating design information.

The Bibliography lists the documents that are referenced informatively in this standard, as well as other documents not cited in this standard but which contain additional useful information. Some of the content of the documents listed might not be suitable for all applications and therefore needs to be assessed for each application before use.

In this standard, quantities are expressed in the International System (SI) of units and the US customary (USC) units.

Pressure-relieving and Depressuring Systems

1 Scope

This standard is applicable to pressure-relieving and vapor depressuring systems. Although intended for use primarily in oil refineries, it is also applicable to petrochemical facilities, gas plants, liquefied natural gas (LNG) facilities, and oil and gas production facilities. The information provided is designed to aid in the selection of the system that is most appropriate for the risks and circumstances involved in various installations.

This standard specifies requirements and gives guidelines for the following:

- examining the principal causes of overpressure;
- determining individual relieving rates;
- selecting and designing disposal systems, including such component parts as piping, vessels, flares, and vent stacks.

This standard does not apply to direct-fired steam boilers.

2 Normative References

The following referenced documents are indispensable for the application of this document. For dated references, only the edition cited applies. For undated references, the latest edition of the referenced document (including any amendments) applies.

API Standard 520, *Sizing, Selection, and Installation of Pressure-relieving Devices, Part 1—Sizing and Selection*, Ninth Edition, 2014

API Standard 520, *Sizing, Selection, and Installation of Pressure-relieving Devices, Part 2—Installation*, Sixth Edition, 2015

API Standard 537, *Flare Details for Petroleum, Petrochemical, and Natural Gas Industries*, Third Edition, Addendum 1, 2020

3 Terms, Definitions, Acronyms, and Abbreviations

3.1 Terms and Definitions

For the purposes of this document, the following definitions apply.

3.1.1

accumulation

Pressure increase over the maximum allowable working pressure (MAWP) of the vessel during discharge through the pressure-relief device.

NOTE Accumulation is expressed in units of pressure or as a percentage of MAWP or design pressure. Maximum allowable accumulations are established by pressure design codes for emergency operating and fire contingencies.

3.1.2

administrative controls

Procedures intended to ensure that personnel actions do not compromise the overpressure protection of the equipment.

3.1.3**assist gas**

Flammable gas that is added to relief gas prior to the flare burner or at the point of combustion in order to raise the heating value.

NOTE In some designs, the assist gas can increase turbulence for improved combustion.

3.1.4**atmospheric discharge**

Release from pressure-relieving and depressuring devices to the atmosphere.

3.1.5**availability**

Fraction of time that a system (e.g. safety instrumented system, atmospheric-relief system, or flare-relief system) is able to perform the designated function if required for use.

3.1.6**backpressure**

Pressure that exists at the outlet of a pressure-relief device or depressuring valve as a result of the pressure in the discharge system.

NOTE The backpressure is the sum of the superimposed and built-up backpressures.

3.1.7**balanced pressure-relief valve**

Spring-loaded pressure-relief valve that incorporates a bellows or other means for minimizing the effect of backpressure on the operational characteristics (set pressure, closing pressure, and relieving capacity) of the valve.

3.1.8**blowdown drum**

Knockout drum with or connected to a stack open to atmosphere.

NOTE 1 The term "blowdown drum" is sometimes also used for knockout drums connected to flare or other disposal systems, but it is not used in this context in this standard.

NOTE 2 The term "blowdown" is sometimes used in the context of emergency depressuring of a plant or part of a plant, but it is not used in this context in this standard.

3.1.9**built-up backpressure**

Increase in pressure at the outlet of a pressure-relief device that develops as a result of flow after the pressure-relief device opens.

3.1.10**burnback**

Internal burning within the flare tip.

NOTE Burnback can result from air backing down the flare burner at purge or low flaring rates.

3.1.11**burning velocity****flame velocity**

Speed at which a flame front travels into an unburned combustible mixture.

3.1.12**burn-pit**

Open excavation, normally equipped with a horizontal flare burner that can handle liquid as well as vapor hydrocarbons.

3.1.13**burst pressure**

Value of the upstream static pressure minus the value of the downstream static pressure just before a rupture disk bursts.

NOTE If the downstream pressure is atmospheric, the burst pressure is the upstream static gauge pressure.

3.1.14**cold differential test pressure****CDTP**

Inlet static pressure at which a pressure-relief valve is adjusted to open on the test stand.

NOTE The CDTP includes corrections for the service conditions of backpressure or temperature or both.

3.1.15**combustion air**

Air provided to burn the combustible gases.

3.1.16**combustion efficiency**

The percentage of the total fuel stream entering the flare that is oxidized to form only the products of complete combustion and heat.

NOTE For example, in the case of hydrocarbons, these products are carbon dioxide, water, and heat.

3.1.17**confined fire**

Fire inside a building or a compact process module where the walls and/or surrounding equipment can reradiate and preheat the combustion air, causing higher heat fluxes than an unconfined (i.e. open) fire.

3.1.18**conventional pressure-relief valve**

Spring-loaded pressure-relief valve whose operational characteristics (set pressure, closing pressure, and relieving capacity) are directly affected by changes in the backpressure.

3.1.19**corrected hydrotest pressure**

Hydrostatic test pressure multiplied by the ratio of stress value at upset temperature to the stress value at test temperature.

NOTE 1 See 4.2.2 and C.7.

NOTE 2 In this definition, the hydrostatic test pressure is that specified by the pressure design code, whether or not the equipment has actually been hydrostatically tested.

3.1.20**deflagration**

Explosion in which the flame front is advancing at less than the speed of sound in the unburned combustible mixture.

NOTE See “detonation” (3.1.23).

3.1.21**design pressure**

Pressure, together with the design temperature, used to determine the minimum permissible thickness or physical characteristic of each component, as determined by the design rules of the pressure design code.

NOTE The design pressure is selected by the user to provide a suitable margin above the most severe pressure expected during normal operation at a coincident temperature, and it is the pressure typically specified on the purchase order. The design pressure is equal to or less than the MAWP (the design pressure can be used as the MAWP in cases where the MAWP has not been established).

3.1.22**destruction efficiency**

Mass percent of the original combustible vapor that is no longer present in the combustion products.

3.1.23**detonation**

Explosion in which the flame front is advancing at or above the speed of sound in the unburned combustible mixture.

NOTE See “deflagration” (3.1.20).

3.1.24**dispersion**

Dilution of a vent stream or products of combustion as the fluids move through the atmosphere.

3.1.25**elevated flare**

Flare where the burner is raised high above ground level to reduce radiation intensity and to aid in dispersion.

3.1.26**enclosed flare**

Enclosure with one or more burners arranged in such a manner that the flame is not directly visible.

3.1.27**flame-retention device**

Device used to prevent flame lift-off from a flare burner.

3.1.28**flare**

Device or system used to safely dispose of relief gases in an environmentally compliant manner through the use of combustion.

3.1.29**flare burner****flare tip**

Part of the flare where fuel and air are mixed at the velocities, turbulence, and concentration required to establish and maintain proper ignition and stable combustion.

3.1.30**flare header**

Piping system that collects and delivers the relief gases to the flare.

3.1.31**flashback**

Phenomenon occurring in a flammable mixture of air and gas when the local velocity of the mixture becomes less than the flame velocity, causing the flame to travel back through the mixture.

3.1.32**fuel-controlled fire**

Fire that always has at least enough air for combustion so the amount of fuel (i.e. the size of the pool or the fuel leak rate) controls the heat release rate.

3.1.33**ground flare**

Nonelevated flare.

NOTE A ground flare is normally an enclosed flare but can also be a ground multiburner flare or a burn-pit.

3.1.34**heat release**

Total heat liberated by combustion of the relief gases based on the lower heating value.

3.1.35**hydrate**

Solid, crystalline compound of water and a low-boiling-point gas (e.g. methane and propane), in which the water combines with the gas molecule to form a solid.

3.1.36**jet fire**

Fire created when a leak from a pressurized system ignites and forms a burning jet.

3.1.37**knockout drum**

Vessel in the effluent handling system designed to remove and store liquids.

3.1.38**lateral**

Section of pipe connecting the outlet(s) of single-source relief device(s) to a header where other sources are tied in.

NOTE The relief flow in a lateral is always from a single source, whereas the relief flow in a header can be from either single or multiple sources simultaneously.

3.1.39**lift**

Actual travel of the disc from the closed position when a valve is relieving.

3.1.40**lift-off**

Apparent separation of a stable or unstable flame above the flare burner, occurring if the fuel velocity exceeds the flame velocity.

3.1.41**liquid seal****water seal**

Device that directs the flow of relief gases through a liquid (normally water) on the path to the flare burner, used to protect the flare header from air infiltration or flashback, to divert flow, or to create backpressure for the flare header.

3.1.42**Mach number**

Actual fluid velocity divided by the velocity at which sound waves propagate through the fluid at the associated temperature.

3.1.43**manifold**

Piping system for the collection and/or distribution of a fluid to or from multiple flow paths.

3.1.44**maximum allowable working pressure****MAWP**

Maximum gauge pressure permissible at the top of a completed vessel in its normal operating position at the designated coincident temperature specified for that pressure.

NOTE 1 See “design pressure” (3.1.21).

NOTE 2 The MAWP is the least of the values for maximum allowed working pressure for any of the essential parts of the vessel.

3.1.45**molecular mass**

The SI term “relative molecular mass” is used rather than “molecular weight” in this standard.

3.1.46**noncondensable gas**

Gas or vapor that remains in the gaseous state at a given temperature and pressure.

3.1.47**open fire**

Fire for which the surroundings do not contribute to preheating the ventilation air or reradiation.

NOTE More heat will be lost to the surroundings as compared with confined fires.

3.1.48**operating pressure**

Pressure the process system experiences during normal operation, including normal variations.

3.1.49**overpressure (general)**

Condition where the MAWP, or other specified pressure, is exceeded.

3.1.50**overpressure (relieving device)**

Pressure increase over the set pressure of a relieving device.

NOTE In the context of a relieving device, overpressure is the same as “accumulation” (3.1.1) only when the relieving device is set to open at the MAWP of the vessel.

3.1.51**pilot-operated pressure-relief valve**

Pressure-relief valve in which the major relieving device or main valve is combined with and controlled by a self-actuated auxiliary pressure-relief valve (pilot).

3.1.52**pin-actuated device**

A nonreclosing pressure-relief device actuated by static pressure and designed to function by buckling or breaking a pin that holds a piston or a plug in place. Upon buckling or breaking of the pin, the piston or plug moves to the full open position.

3.1.53**pool fire**

Burning pool of liquid.

3.1.54**pressure design code**

Standard to which the equipment is designed and constructed.

EXAMPLE ASME *BPVC, Section VIII: Rules for Construction of Pressure Vessels* [17].

3.1.55**pressure-relief device**

Device actuated by inlet static pressure and designed to open during emergency or abnormal conditions to prevent a rise of internal fluid pressure in excess of a specified design value.

NOTE The device may be a pressure-relief valve, a rupture disk device, or a pin-actuated device.

3.1.56**pressure-relief valve**

Valve designed to open and relieve excess pressure and to reclose and prevent the further flow of fluid after normal conditions have been restored.

NOTE Other terms used for pressure-relief valve (PRV) include pressure safety valve (PSV), relief valve, safety valve, and safety-relief valve.

3.1.57**pressure system**

System of vessels, pipes, and other equipment operating with an internal pressure exceeding atmospheric.

3.1.58**process tank****process vessel**

Tank or vessel used for an integrated operation in petrochemical facilities, refineries, gas plants, oil and gas production facilities, and other facilities.

NOTE 1 See "storage tank" (3.1.76).

NOTE 2 A process tank or vessel used for an integrated operation can involve, but is not limited to, preparation, separation, reaction, surge control, blending, purification, change in state, energy content, or composition of a material.

3.1.59**purge gas**

Flammable gas or noncondensable inert gas added to the flare header to mitigate air ingress and burnback.

3.1.60**quenching**

Cooling of a fluid by mixing it with another fluid of a lower temperature.

3.1.61**radiation intensity**

Local radiant heat transfer rate from the flare flame, usually considered at grade level.

3.1.62**rated capacity**

Rated flow of a pressure-relief device, determined in accordance with the pressure design code or regulation and supplied by the manufacturer.

NOTE The capacity marked on the device is the rated capacity on steam, air, gas, or water as required by the applicable code.

3.1.63**relief gas**

All gases and vapors sent to the flare tip, not including entrained air, and consisting of the sum of organic material, nitrogen, and any other gases added to the vent gas collection system, natural gas added as supplemental fuel, nitrogen added as purge gas, natural gas flowing to the flare pilots, and steam added at the flare tip.

NOTE Other terms used for relief gas include flared gas, vent gas, waste gas, and waste vapor.

3.1.64**relief valve**

Spring-loaded pressure-relief valve actuated by the static pressure upstream of the valve, which normally opens in proportion to the pressure increase over the set pressure.

NOTE A relief valve is normally used with incompressible fluids.

3.1.65**relieving conditions**

Inlet pressure and temperature on a pressure-relief device during an overpressure condition.

NOTE The relieving pressure is equal to the valve set pressure (or rupture disk burst pressure) plus the overpressure. The temperature of the flowing fluid at relieving conditions can be higher or lower than the operating temperature.

3.1.66**required relief rate**

Estimated flow rate that needs to be relieved to prevent the equipment pressure from exceeding the specified design value.

3.1.67**risk**

A measure of potential injury, environmental damage, or economic loss in terms of both the incident likelihood and the severity of the loss or injury.

NOTE API 752 ^[8] provides additional discussion of risk.

3.1.68**rupture disk device**

Nonreclosing pressure-relief device actuated by static differential pressure between the inlet and outlet of the device and designed to function by the bursting of a rupture disk.

NOTE A rupture disk device includes a rupture disk and a rupture disk holder.

3.1.69**safety instrumented system****SIS****high-integrity protection system****HIPS**

System composed of sensors, logic solvers, and final control elements for the purpose of taking the process to a safe state when predetermined conditions are met.

NOTE Other terms commonly used for an SIS include emergency shutdown system (ESD, ESS), safety shutdown system (SSD), and safety interlock system (see E.3.3.1).

3.1.70
safety integrity level

SIL

Discrete integrity level of a safety instrumented function in a safety instrumented system.

NOTE SILs are categorized in terms of probability of failure (see Annex E).

3.1.71
safety relief valve

Spring-loaded pressure-relief valve that can be used as either a safety valve or a relief valve depending on the application.

3.1.72
safety valve

Spring-loaded pressure-relief valve actuated by the static pressure upstream of the valve and characterized by rapid opening or pop action.

NOTE A safety valve is normally used with compressible fluids.

3.1.73
set pressure

Inlet gauge pressure at which a pressure-relief device is set to open under service conditions.

3.1.74
staged flare

Group of two or more flares or burners that are controlled so that the number of flares or burners in operation is proportional to the relief gas flow.

3.1.75
stoichiometric air/fuel ratio

Chemically correct ratio of air to fuel capable of perfect combustion with no unused fuel or air.

3.1.76
storage tank
storage vessel

Fixed tank or vessel that is not part of the processing unit in petrochemical facilities, refineries, gas plants, oil and gas production facilities, and other facilities.

NOTE 1 See "process tank" (3.1.58).

NOTE 2 These tanks or vessels are often located in tank farms.

3.1.77
superimposed backpressure

Static pressure that exists at the outlet of a pressure-relief device at the time the device is required to operate.

NOTE It is the result of pressure in the discharge system coming from other sources and can be constant or variable.

3.1.78
vapor depressuring system

Protective arrangement of valves and piping intended to provide for rapid reduction of pressure in equipment by releasing vapors.

NOTE The actuation of the system can be automatic or manual.

3.1.79**vent header**

Piping system that collects and delivers the relief gases to the vent stack.

3.1.80**vent stack**

Elevated vertical termination of a disposal system that discharges vapors into the atmosphere without combustion or conversion of the relieved fluid.

3.1.81**ventilation-controlled fire**

Fire that is in shortage of air such that the available air—the ventilation—controls the heat release rate.

3.1.82**vessel**

Container or structural envelope in which materials are processed, treated, or stored [e.g. pressure vessels, reactor vessels, and storage vessels (tanks)].

3.2 Acronyms and Abbreviations

BLEVE	boiling liquid expanding vapor explosion
BRL	Ballistic Research Laboratory
CCPS	Center for Chemical Process Safety
CDTP	cold differential test pressure
CUI	corrosion under insulation
DN	diameter nominal (nominal diameter)
ERPG	emergency response planning guideline
ESD	emergency shutdown system
ESS	emergency shutdown system
F&G	fire and gas
HIPS	high-integrity protection system
LAH	high liquid level alarm
LAHH	high-high liquid level alarm
LNG	liquefied natural gas
LOF	likelihood of failure
LOPA	layer of protection analysis
LPG	liquefied petroleum gas
LSHH	level switch high-high (high-high level shutdown)
MAWP	maximum allowable working pressure

MOC	management of change
NPS	nominal pipe size
PFD	process flow diagram or probability of failure on demand
PFP	passive fire protection
PHA	process hazard analysis
P&ID	piping and instrumentation diagram
PRD	pressure-relief device
PRV	pressure-relief valve
RPT	rapid phase transition
SI	International System of units
SIL	safety integrity level
SIS	safety instrumented system
SLT	superheat limit temperature
SSD	safety shutdown system
SRU	sulfur recovery unit
USC	US customary units
UTS	ultimate tensile strength
VOC	volatile organic compound
WHSG	waste heat steam generator

4 Causes of Overpressure and Their Relieving Rates

4.1 General

Pressure vessels, heat exchangers, operating equipment, and piping are designed to contain the system pressure. The design is based on the following:

- a) the normal operating pressure at operating temperatures;
- b) the effect of any combination of process upsets that are likely to occur during normal operations;
- c) the differential between the operating and set pressures of the pressure-relief device (PRD);
- d) the effect of any combination of supplemental internal loadings such as static head and external loadings such as earthquake and wind.

Section 4 discusses the principal causes of overpressure where the maximum allowable working pressure (MAWP), design pressure, or other specified pressure can be exceeded. Guidance in plant design to minimize the effects of these overpressure causes and guidance on estimating relieving rates is provided. Overpressure is the result of an unbalance or disruption of the normal flows of material and energy that causes the material or energy, or both, to

build up in some part of the system. Analysis of the causes and magnitudes of overpressure is, therefore, a special and complex study of material and energy balances in a process system.

The principal causes of overpressure listed in 4.4.2 through 4.4.16 are guides to generally accepted practices. The process systems designer shall define the minimum pressure-relief capacity required to prevent the pressure in any piece of equipment from exceeding the maximum allowable accumulated pressure. Annex B provides guidance on the use of a common relief device to protect multiple pieces of equipment from overpressure.

All equipment operations/status should be considered when establishing overpressure protection for the equipment, including, but not limited to, nonroutine situations such as start-up, shutdown, maintenance, standby, and out-of-service as defined by the user. Overpressure protection shall be considered when mass and/or energy exchange is possible for the equipment being considered. Equipment protection should consider the isolation practices as defined by the user. The equipment operations/status and protection methods should be consistent with isolation practice as defined by the user. Table 1 in 4.4 may be helpful in determining the need for overpressure protection for nonroutine situations.

The application of the principles outlined in Section 4 is unique for each processing system. Although efforts have been made to cover all major circumstances, the user is cautioned not to consider the conditions described as the only causes of overpressure. The treatment of overpressure in this standard can be only suggestive. Any circumstance that reasonably constitutes a hazard under the prevailing conditions for a system should be considered in the design. PRDs are installed to ensure that a process system or any of its components is not subjected to pressures that exceed the maximum allowable accumulated pressure. The practices evaluated in Section 4 should be used in conjunction with sound engineering judgment and with full consideration of federal, state, and local rules and regulations.

4.2 Overpressure Protection Philosophy

4.2.1 Hierarchy of Protective Measures

A hierarchy of measures should be used to ensure that equipment is not subject to excess pressure. Such a hierarchy first involves avoiding or reducing risks, then providing engineering controls, and finally providing administrative controls. Avoiding risks includes, for example, setting the MAWP of the equipment above the maximum pressure of all possible sources. Engineering controls include providing pressure relief on the vessel. Administrative controls include provision of block valves of the locked-open design. The user is cautioned that some systems may have unacceptable risk due to failure of administrative controls and resulting consequences due to loss of containment.

4.2.2 Use of Administrative Controls if Corrected Hydrotest Pressure Not Exceeded

It is the responsibility of the user to determine the overpressure scenarios upon which the pressure relief system is designed, and to determine the method of overpressure protection used to mitigate each scenario in accordance with the relevant codes. It is the responsibility of the user to determine whether administrative controls are included in the basis for the pressure relief system design.

If administrative controls are used to eliminate an overpressure scenario as a basis for the pressure relief system design, the user shall evaluate the potential overpressure in the event the administrative control fails, compare it to the equipment corrected hydrotest pressure, and consider additional risk reduction if the corrected hydrotest pressure can be exceeded.

This philosophy is applied to the following scenarios:

- a) closed outlets on vessels (see 4.4.2);
- b) inadvertent valve opening (see 4.4.9.2);
- c) check valve leakage or failure (see 4.4.9.3);
- d) heat transfer equipment failure (see 4.4.14).

The user is cautioned that some systems can have unacceptable risk due to failure of administrative controls and resulting consequences due to loss of containment. In these cases, limiting the overpressure to the normally allowable overpressure can be more appropriate. Note that the entire system, including all of the auxiliary devices (e.g. gasketed joints, instrumentation), should be considered for the overpressure during the failure of administrative controls.

Note that the corrected hydrotest pressure accounts for allowable stress differences of the material of construction between the overpressure scenario temperature (relieving temperature) and either the test temperature or the design temperature (usually higher than the test temperature). Details and examples of the corrected hydrotest pressure are given in C.7.

4.2.3 Double Jeopardy

The causes of overpressure are considered to be unrelated (i.e. independent) if no process or mechanical or electrical linkages exist among them or if the length of time that elapses between possible successive occurrences of these causes is sufficient to make their classification unrelated. The simultaneous occurrence of two or more unrelated causes of overpressure (also known as double or multiple jeopardy) is not a basis for design. Examples of double jeopardy scenarios are fire exposure simultaneous with heat exchanger internal tube failure, fire exposure simultaneous with failure of administrative controls to drain and depressure isolated equipment, or operator error that leads to a blocked outlet coincident with a power failure. On the other hand, instrument air failure during fire exposure may be considered single jeopardy if the fire exposure causes local air line failures. See 4.2.6 for additional guidance.

This standard describes single jeopardy scenarios that should be considered as a basis for design. The user may choose to go beyond these practices and assess multiple jeopardy scenarios, particularly for severe consequence events. Because such assessments are outside the basis for design, the user is not required to meet accumulations allowed by the pressure design code for these scenarios. Acceptance criteria are the sole responsibility of the user.

4.2.4 Latent Failures

Latent failures should normally be considered as an existing condition and not as a cause of overpressure when assessing whether a scenario is single or double jeopardy. For example, latent failures can exist in instrumentation that prevents it from functioning favorably during an overpressure condition. It is not double jeopardy to assume the absence of beneficial instrumentation response in combination with an unrelated overpressure cause. Likewise, it is not double jeopardy to assume a latent failure of a check valve allowing reverse flow during a pump failure.

4.2.5 Operator Error/Effect of Operator Response

Operator error is considered a potential source of overpressure.

The decision to take credit for operator response in determining maximum relieving conditions requires consideration of those who are responsible for operation and an understanding of the consequences of an incorrect action. A commonly accepted time range for the response is between 10 min and 30 min, depending on the complexity of the plant. The effectiveness of this response depends on the process dynamics.

When considering operator intervention, the user should ensure:

- a) there is an alarm of the abnormal event or condition independent of the initiating event, which will alert the operator to intervene;
- b) there is sufficient time for the operator to diagnose the alarm(s) and take appropriate action to intervene and mitigate the specific event of interest. Note that there may be instances of "alarm overload" where many alarms simultaneously sound such as in the event of a power failure;
- c) the operator is trained to take the mitigation action and has the authority to take the actions to mitigate the event; the training includes a written procedure associated with the alarm and corrective actions;
- d) the consequences of operator intervention failure are understood;

- e) the probability of alarm failure and/or ineffective operator intervention (e.g. incorrect action or mitigation does not work) is evaluated.

4.2.6 Role of Instrumentation in Overpressure Protection

Fail-safe devices, automatic start-up equipment, and other conventional instrumentation should not be a substitute for properly sized PRDs as protection against single jeopardy overpressure scenarios. There can be circumstances, however, where the use of PRDs is impractical and reliance on instrumented safeguards is needed. Where this is the case, if permitted by local regulations, a PRD might not be required.

EXAMPLE See ASME *BPVC*, Section VIII, Division 1, UG-140, *Overpressure Protection by System Design*.

The design shall comply with the local regulations and the user's risk tolerance criteria, whichever is more restrictive. If these risk tolerance criteria are not available to perform analyses per the guidance in Annex E, then as a minimum, the overall system performance including instrumented safeguards should provide safety integrity level 3 (SIL-3) performance in accordance with ISA 84.01 [91].

Although favorable response of conventional instrumentation should not be assumed when sizing individual process equipment pressure relief, in the design of some components of a relieving system, such as the collection header, flare, and flare tip, favorable response of some instrument systems can be assumed. The decision to base the design of such systems on excluded or reduced specific loads due to the favorable response of instrument systems should consider the number and reliability of applicable instrument systems. See Section 5 for more details on sizing disposal systems.

Some pipeline design codes (e.g. ASME B31.8 [19]) permit the use of a pressure limiting station to protect gas transmission lines, in place of, or in addition to, a PRD. A pressure limiting station is defined as "equipment that under abnormal conditions acts to reduce, restrict, or shutoff the supply of gas flowing into a system to prevent the gas pressure from exceeding a predetermined value." The design options for these pressure limiting stations are prescribed by ASME B31.8 and typically include a combination of multiple pressure regulators in addition to a shutdown valve.

4.3 Determination of Individual Relieving Rates

4.3.1 General Philosophy

The basis for determining individual relieving rates that result from various causes of overpressure is presented in the form of general considerations and specific guidelines. Good engineering judgment, rather than blind adherence to these guidelines, should be followed in each case. The results achieved should be economically, operationally, and mechanically feasible, but in no instance should the safety of a plant or its personnel be compromised.

The liquid or vapor rates used to establish relief requirements are developed by the net energy input. The two most common forms of energy are:

- a) heat input, which increases pressure through vaporization or thermal expansion, and
- b) direct pressure input from higher-pressure sources.

Overpressure can result from one or both of these sources.

The peak individual relieving rate is the maximum rate at which the pressure shall be reduced to protect equipment against overpressure due to any single cause. The probability of two unrelated failures occurring simultaneously is remote and normally does not need to be considered (see 4.2.3).

4.3.2 Effects of Pressure, Temperature, and Composition

Pressure and temperature should be considered to determine individual relieving rates, since they affect the volumetric and compositional behavior of liquids and vapors. Vapor is generated when heat is added to a liquid. The rate at which vapor is generated changes with equilibrium conditions because of the increased pressure in a

confined space and the heat content of streams that continue to flow into and out of the equipment. In many instances, a volume of liquid can be a mixture of components with different boiling points. Heat introduced into fluids that do not reach their critical temperature under pressure-relieving conditions produces a vapor that is rich in low-boiling components. As heat input is continued, the vapor is enriched with heavier components. Finally, if the heat input is sufficient, the heaviest components are vaporized.

During pressure relieving, the changes in vapor rates and relative molecular masses at various time intervals should be investigated to determine the peak relieving rate and the composition of the vapor. The composition of inflowing streams can also be affected by variations in time intervals and therefore requires study.

Relieving pressure can sometimes exceed the critical pressure (or pseudo-critical pressure) of the components in the system. In such cases, reference shall be made to compressibility correlations to compute the density-temperature-enthalpy relationships for the system fluid. If the overpressure is the result of an inflow of excess material, then the excess mass quantity shall be relieved at a temperature determined by equating the incoming enthalpy with the outgoing enthalpy.

In a system that has no other inflow or outflow, if the overpressure is the result of an extraneous excess heat input, the quantity to be relieved is the difference between the initial contents and the calculated remaining contents at any later time. The cumulative extraneous enthalpy input is equal to the total gain in enthalpy by the original contents, whether they remain in the container or are vented. By calculating or plotting the cumulative vent quantity versus time, the maximum instantaneous relieving rate can be determined. This maximum usually occurs near the critical temperature. In such cases, the assumption of an ideal gas can be too conservative, and Equation (9) (see 4.4.13.2.4.3) oversizes the pressure-relief valve (PRV).

4.3.3 Dynamic Simulation

Dynamic simulation can be used in pressure-relief system design to calculate transient pressure increases as indicated in 4.4.14 or to calculate required relief rates from individual PRDs. Conventional methods for calculating relief loads are generally conservative and can lead to overly sized relief and flare system designs. Dynamic simulation provides an alternative method to better define the relief load and improves the understanding of what happens during relief.

Dynamic simulation can be applied wherever conventional methods can be applied. Relief load calculations using dynamic simulation shall follow the same rules set elsewhere in this standard for performing relief load calculations using conventional calculation methods. It can be necessary to perform sensitivity analyses with respect to control response in order to identify appropriate control response. In general, no allowance should be taken for automatic control action unless it tends to increase the relief load. The user is cautioned that the inputs, dynamic calculation methods, and results of the dynamic model need to be validated.

Dynamic simulation can be used in systems such as columns, compression, multiple loop refrigeration systems, and heat exchanger tube ruptures (see 4.4.14.2.2) and in analyzing existing flare systems (see 5.3.4.2). A dynamic simulation of a column is discussed below.

If dynamic simulation is used for column-relief system design, it is necessary to ensure that the model is conservative with respect to calculating the maximum relief load. If the physical phenomena are not well understood, the dynamic simulation model shall include conservative assumptions. These assumptions shall be checked by sensitivity analyses to assess their impact on the column-relief load. For example, several simulation runs can be required to determine the effect of different froth correlations on the tray liquid holdup and resulting relief load. Additionally, it can be advisable to have operating personnel review the appropriate aspects of the model. The user of the dynamic simulation program should be aware of the underlying assumptions that are built into the dynamic simulation software code and how they affect the results. The user should not use a dynamic simulation developed for another purpose (i.e. operator training) and assume that this model gives accurate relief loads without a detailed review of the modeling assumptions.

At steady-state conditions, the dynamic model shall closely match the steady-state model. The model shall reflect current or expected operation. An adequate level of detail is required to assure accurate predictions of peak relief loads. The model shall incorporate physical features of the system (e.g. liquid inventories of vessels and piping). Sensitivity analyses should be performed for the full range of operating conditions (e.g. variable compositions and turndown rates). For example, the differences in tray-draining mechanisms between valve and sieve trays can have

a significant impact on the calculated relief load for some columns. An accurate estimate of tray inventories can also be important where column light-ends inventory can impact the peak relief load.

If dynamic simulation is used, sensitivity analyses shall be performed to assess factors such as the effect of PRDs with excess capacity, the action of automatic controls, controller tuning, heat integration with other columns, and operator intervention. These factors increase the number of run permutations that shall be performed.

4.4 Individual Overpressure Causes and Their Relieving Rates

4.4.1 General

Table 1 lists some common occurrences that can require overpressure protection. This table is not intended to be all-inclusive or complete in suggesting maximum required relieving rates; it is merely recommended as a guide. A more descriptive analysis is provided in the remainder of 4.4.

4.4.2 Closed Outlets

4.4.2.1 Description of a Closed Outlet

The inadvertent closure of a valve on the outlet of pressure equipment while the equipment is on stream can expose the equipment to a pressure that exceeds the MAWP. Every valve (i.e. manual, control, or remotely operated) should be considered as being subject to inadvertent operation. If closure of an outlet valve can result in pressure in excess of that allowed by the design code, a PRD is required. If the equipment is designed to the maximum source pressure, then closure of an outlet valve will not result in overpressure, so a PRD is not required for the closed outlet scenario.

In the case of a manual valve, administrative controls can be used to prevent the closed outlet scenario, subject to 4.2.1 and 4.2.2. Note that the entire system including all of the auxiliary devices (e.g. gasketed joints, instrumentation) should be considered for the overpressure during the failure of administrative controls.

In general, the elimination of block valves and the omission of block valves in between vessels in a series can reduce the number of PRDs.

4.4.2.2 Additional Considerations Involving Pumps

The system does not require relief protection for the closed outlet (i.e. shut-in) scenario if the pump, piping, and other equipment downstream of a centrifugal pump (which can be exposed to the shut-in pressure of the pump, e.g. closed block valve in the discharge system) are designed to withstand the maximum shut-in pressure of the pump or other pressure source such as a start-up or warm-up line.

For positive displacement pumps, pressure-relief protection is usually required to protect the pump itself and downstream equipment against shut-in conditions.

4.4.2.3 Additional Considerations Involving Reciprocating Compressors

Even where there are no block valves between stages, interstage PRD(s) might be required to prevent overpressure in the event of loss of interstage cooling. A remote—but possible—contingency, however, would be internal failure of one of the downstream stages. Loss of downstream stage compression would essentially shift all of the gas compression work to the previous stage. A PRD sized for the blocked outlet flow conditions at the interstage design pressure is required to prevent overpressure.

Table 1—Guidance for Required Relieving Rates Under Selected Conditions

Item No.	Condition	Section	Liquid-relief Guidance ^a	Vapor-relief Guidance ^a
1	Closed outlets	4.4.2	Maximum liquid pump-in rate	Total incoming steam and vapor plus that generated therein at relieving conditions
2	Cooling-water failure to condenser	4.4.3	—	Total vapor to condenser at relieving conditions
3	Top-tower reflux failure	4.4.3	—	Total incoming steam and vapor plus that generated therein at relieving conditions less vapor condensed by sidestream reflux
4	Sidestream reflux failure	4.4.3	—	Difference between vapor entering and leaving equipment at relieving conditions
5	Lean-oil failure to absorber	4.4.4	—	None, normally
6	Accumulation of noncondensables	4.4.5	—	Same effect in towers as found for Item 2; in other vessels, same effect as found for Item 1
7	Entrance of highly volatile material	4.4.6	—	Use alternative means of protection to avoid scenario; see Item 15 for heat exchanger tube rupture guidance
	a) Water into hot oil	4.4.6.1	—	
	b) Light hydrocarbons into hot oil	4.4.6.2	—	
8	Overfilling	4.4.7	Maximum liquid pump-in rate	—
9	Failure of automatic controls	4.4.8	—	Analyze on a case-by-case basis
	a) Inlet control devices and bypasses	4.4.8.3		
	b) Outlet control devices	4.4.8.4		
	c) Fail-stationary valves	4.4.8.5		
	d) Choke valves	4.4.8.6		
10	Abnormal process heat or vapor input	4.4.9	—	
	a) Abnormal process heat input	4.4.9.1		Estimated maximum vapor generation including noncondensables from overheating
	b) Inadvertent valve opening	4.4.9.2		
	c) Check valve failure	4.4.9.3		
11	Internal explosions or transient pressure surges (e.g. water, steam, or condensate hammer)	4.4.10	Not controlled by conventional PRDs but by avoidance of circumstances	Not controlled by conventional PRDs but by avoidance of circumstances
12	Chemical reaction	4.4.11	—	Estimated gas/vapor generation from both normal and uncontrolled conditions; consider two-phase effects
13	Hydraulic expansion	4.4.12		
	a) Cold-fluid shut-in	4.4.12	See 4.4.12	—
	b) Lines outside process area shut-in	4.4.12	See 4.4.12	—
14	Exterior fire	4.4.13		Estimated by the methods given in 4.4.13.2 or Annex A
15	Heat transfer equipment failure	4.4.14		
	a) Heat exchanger tube rupture	4.4.14.2	Liquid flowing across a rupture equal to twice the cross-sectional area of one tube	Steam or vapor flowing across a rupture equal to twice the cross-sectional area of one tube
	b) Double pipe	4.4.14.3		
	c) Plate and frame	4.4.14.4		

Table 1—Guidance for Required Relieving Rates Under Selected Conditions (continued)

Item No.	Condition	Section	Liquid-relief Guidance ^a	Vapor-relief Guidance ^a
16	Power failure (steam, electric, or other)	4.4.15	—	Study the installation to determine the effect of power failure; size the relief valve for the worst condition that can occur
	a) Fractionators		—	Loss of all pumps, with the result that reflux and cooling water would fail
	b) Reactors		—	Consider failure of agitation or stirring, quench or retarding stream; size the valves for vapor generation from a runaway reaction
	c) Air-cooled heat exchangers		—	Fan failure; size valves for the difference between normal and emergency duty
	d) Surge vessels		—	Maximum liquid inlet rate
17	Maintenance	4.4.16	—	—

^a Consideration can be given to the reduction of the relief rate as the result of the relieving pressure being above operating pressure.

4.4.2.4 Relieving Rate Estimation for a Closed Outlet

For determining relief loads, it may be assumed that manual or remotely operated valves that are normally open and functioning at the time of inadvertent closure or failure and that are not affected by the primary cause of failure remain in operation at their normal operating positions. A check of possible common mode failures that can affect multiple valves simultaneously (e.g. control systems, electrical equipment, etc.) should be made to assure that the valves are independent and would not be affected by the primary failure.

The quantity of material to be relieved should be determined at conditions that correspond to relieving conditions instead of at normal operating conditions. The required relieving rate is often reduced appreciably when this difference in conditions is considered. The effect of frictional pressure drop in the connecting line between the source of overpressure and the system being protected should also be considered in determining the required relieving rate.

4.4.3 Cooling or Reflux Failure

4.4.3.1 Description of the Cooling or Reflux Failure

The failure of electrical or mechanical equipment that provides cooling or condensation in process streams can cause overpressure in process vessels. The loss of reflux as a result of pump or instrument failure can cause overpressure in a column because of condenser flooding or loss of coolant in the fractionating process. Fans on air-cooled heat exchangers or cooling towers occasionally become inoperative because of a loss of power or a mechanical breakdown. On cooling towers and air-cooled heat exchangers where independent operation of the louvers can be maintained, credit for the cooling effect may be obtained by convection and radiation.

4.4.3.2 Relieving Rate Estimation for Loss of Cooling or Reflux

4.4.3.2.1 General

The required relieving rate is determined by a heat and material balance on the system at the relieving pressure. In a distillation system, the rate can require calculation with or without reflux. Credit is normally not taken for the effect of residual coolant after the cooling stream fails because this effect is time limited and depends on the physical configuration of the piping. However, if the process piping system is unusually large and bare, the effect of heat loss to the surroundings may be considered.

Because of the difficulty in calculating detailed heat and material balances, the simplified bases described in 4.4.3.2.2 through 4.4.3.2.9 have generally been accepted for determining relieving rates.

4.4.3.2.2 Total Condensing

The required relieving rate is the total incoming vapor rate to the condenser, recalculated at a temperature that corresponds to the new vapor composition at relieving conditions, and the heat input prevailing at the time of relief. The surge capacity of the overhead accumulator at the normal liquid level is generally limited to less than 10 min. If cooling failure exceeds this time, reflux is lost and the overhead composition, temperature, and vapor rate can change significantly.

4.4.3.2.3 Partial Condensing

The required relieving rate is the difference between the incoming and outgoing vapor rate at relieving conditions. The incoming vapor rate should be calculated on the same basis used in 4.4.3.2.2. If the composition or rate of the reflux is changed, the incoming vapor rate to the condenser should be determined for the new conditions.

4.4.3.2.4 Air Cooler Fan Failure

Because of natural convection effects, credit for a partial condensing capacity of 20 % to 30 % of normal air cooler duty is often used, unless the effects at relieving conditions are determined to be significantly different. The required relieving rate is then based on the remaining 70 % to 80 %, depending on the service (see 4.4.3.2.2 and 4.4.3.2.3). However, the actual duty available by natural convection is usually a function of the air-cooled heat exchanger design. Some designs can allow significantly more credits if a supporting engineering analysis is performed. In addition, reduction in cooling capabilities can also occur if variable-pitch fans are used and a failure of the pitch mechanism occurs.

4.4.3.2.5 Louver Closure

Louver closure on air coolers is considered to result in total loss of cooling. Louver closure can result from automatic control failure, mechanical linkage failure, or destructive vibration on a manually positioned louver.

4.4.3.2.6 Overhead Circuit

In many cases, failure of the reflux that results, for example, from pump shutdown or valve closure, causes flooding of the overhead condenser, which is equivalent to total loss of cooling. Compositional changes caused by loss of reflux can produce different vapor properties that affect the required relieving rate. A PRD sized for total failure of the coolant is usually adequate for this condition, but each case shall be examined in relation to the particular components and system involved.

4.4.3.2.7 Pump-around Circuit

The required relieving rate is the vaporization rate caused by an amount of heat equal to that removed in the pump-around circuit. The latent heat of vaporization corresponds to the latent heat under the relieving conditions of temperature and pressure at the point of relief.

4.4.3.2.8 Overhead Circuit Plus Pump-around

An overhead circuit plus pump-around is usually arranged so that simultaneous failure of the pump-around and the overhead condenser do not occur; however, partial failure of one with complete failure of the other is quite possible. The required relieving rate is discussed in 4.4.3.2.6 and 4.4.3.2.7.

4.4.3.2.9 Sidestream Reflux Failure

Principles similar to those described in 4.4.3.2.6 and 4.4.3.2.7 apply in overhead condenser flooding (if a condenser is in the system) or changes in vapor properties resulting from changes in composition. The required relieving rate should be large enough to relieve the vaporization rate caused by the amount of heat normally removed from the system.

4.4.4 Absorbent Flow Failure

For lean-oil absorption of hydrocarbons, generally no relief requirement results from lean-oil failure. However, in an acid gas removal unit in which large quantities (25 % or more) of the inlet vapor can be removed in the absorber, loss of absorbent can cause a pressure rise to relief pressure, since the downstream system might not be adequate to handle the increased vapor flow.

Each individual case shall be studied for its process and instrumentation characteristics. The study should include the effect on downstream process units in addition to the reaction in piping and instrumentation immediately downstream of the absorber.

4.4.5 Accumulation of Noncondensables

Noncondensables do not accumulate under normal conditions because they are released with the process streams. If the noncondensables accumulate to the point of blanketing (vapor-locking) the overhead condenser, the effect may be equal to a total loss of cooling. In addition, some relief scenarios may introduce noncondensables that may have the same effect.

4.4.6 Entrance of Volatile Material into the System

4.4.6.1 General

Violent explosions have occurred in the refining, petrochemical, LNG, and other industries due to mixing water or a light hydrocarbon with a significantly hotter fluid or direct contact of the volatile fluid with a hot surface. These physical explosions are termed “superheat-limit explosions,” “vapor explosions,” “steam explosions,” or “rapid phase transitions” (RPTs) [104]. The commonality of these explosions is that cold, volatile liquid is superheated well above its normal boiling temperature at a given pressure. The consensus of published research on this phenomenon is that in order for such explosions to occur, the hot liquid or surface temperature must exceed the superheat limit temperature (SLT) of the cooler volatile liquid. At constant pressure, the SLT is defined as the highest temperature below thermodynamic critical temperature that a liquid can attain without undergoing RPT to vapor. If the SLT is reached or exceeded, the liquid will flash into vapor, in some cases within microseconds. This timeframe is analogous to a detonation. Similar to a chemical detonation, a superheat limit explosion can produce shock waves that generate significantly more damage than that generated by the volume expansion accompanying the conventional vaporization of a liquid. Because of the shock wave potential, PRDs do not provide any mitigation against a superheat limit explosion.

Examples where superheat limit explosions are possible include:

- a) discharge hot heavies/oil into knockout drum containing a layer of water or light hydrocarbon or vice versa;
- b) introduction of water in the feed to a hot feed surge drum;
- c) start-up of hot oil systems containing residual water from maintenance;
- d) hot oil heat exchanger tube failure;
- e) other inadvertent mixing scenarios due to instrumentation, mechanical, or operator error.

4.4.6.2 Superheat Limit Temperature Data

SLTs are experimentally determined. In the case of water, an SLT of 536 °F (280 °C) at atmospheric pressure has been determined [28] [31]. See Reference 31 for experimentally determined SLTs of other pure components. (Note that the values for T_c for methane, ethane, and propane in Table 1 of Reference [28] should be 190K, 305K, and 369K, respectively).

The SLT for pure components can also be estimated using Equation (1) if the critical temperature and pressure are known [141]:

$$T_{sl} = T_{crit} \left[\left(0.11 \frac{P}{P_{crit}} \right) + 0.89 \right] \quad (1)$$

where

- T_{sl} is the superheat limit temperature, expressed in K (°R);
- T_{crit} is the thermodynamic critical temperature, expressed in K (°R);
- P is the system pressure (e.g. design pressure), expressed in kPa (psia);
- P_{crit} is the critical pressure, expressed in kPa (psia).

If the hot fluid or surface temperature cannot exceed the SLT, then PRDs can be considered (see 4.4.6.3). If the hot fluid or surface temperature equals or exceeds the SLT, then PRDs do not provide mitigation (see 4.4.6.4).

4.4.6.3 Pressure-relief Device Design Considerations When Below the Superheat Limit Temperature

PRDs can be considered if the temperature of the hotter fluid does not exceed the SLT of the cooler volatile fluid. However, the user is cautioned that as the temperature approaches the SLT, violent boiling with pressure spikes along with slug flow will likely occur with potential for equipment damage depending upon the equipment configuration. Assuming steady-state boiling under these dynamic conditions can lead to underestimating the peak relief load. Further assessments should be considered to determine whether equipment failure is possible under these circumstances.

4.4.6.4 Design Considerations When Above the Superheat Limit Temperature

The user is cautioned not to analyze the potential for superheating liquid to the SLT given the inherent complexities with the heat transfer and mixing processes within equipment. Incidents demonstrate that only small amounts of the cool, volatile liquid are necessary to cause significant damage from a superheat-limit explosion. Proper design, commissioning, and operation of the process system are essential in attempts to eliminate an explosion possibility when above the SLT.

The following are some precautions that can be taken to minimize, though not eliminate, the potential for superheat-limit explosions:

- a) maintaining minimum circulation of hot oil through equipment on standby in order to minimize collection of water;
- b) avoiding water-collecting pockets;
- c) installing proper steam condensate traps;
- d) installing heat tracing to eliminate condensation;
- e) installing double block and bleed valves on water connections to hot process lines;
- f) installing interlocks to trip sources of heat in the event of water-contaminated feedstock;
- g) commissioning and start-up procedures to allow for gradual temperature increase.

Note that incidents have shown that explosions can occur if the hot fluid is added to cooler volatile fluid or vice versa. Hence, designing the water side of a heat exchanger to be at a lower operating pressure than the hot oil side is not an effective mitigation.

4.4.7 Overfilling

4.4.7.1 General

Many process or surge vessels, including columns and towers, have a liquid level present during normal, start-up, or shutdown conditions. Experience has shown that this equipment can be overfilled under certain conditions. If the source pressure of a liquid feed or supply line can exceed the relief device set pressure and/or the design pressure of the equipment, then overfilling shall be evaluated. System design options to deal with liquid overfill include but are not limited to:

- a) increasing the system design pressure and/or PRD set pressure within pressure design code allowances;
- b) designing a pressure-relief system that can safely accommodate the overfill (including the effects of operator intervention response as discussed in 4.2.5);
- c) installing a safety instrumented system (SIS) to prevent the liquid overfill (see Annex E for additional information on SISs).

For all design options, all phases of operation shall be evaluated. Particular attention shall be given to start-up and other nonroutine operations where process conditions (e.g. flow rates, temperature, and density) can be different from normal and where conditions that lead to overfilling can be more likely to occur when compared with normal operations.

The user shall validate the design (foundation, piping, etc.) consistent with the liquid overfill scenario. In addition, the specified design pressures should have a suitable margin between the maximum pressure that would result during overfill and the PRD set pressure where the consequences of the liquid-relief discharge would be significant. If there is not a suitable margin, then the disposal system should be designed to accommodate the liquid release.

If operator intervention is used as part of the system design, then the risk of failure of the operator to properly intervene shall be addressed. The PRD may discharge back into a disposal system such as a lower-pressure section of the process, a flare, or into another disposal system. If it is a basis for the disposal system design, then the user shall consider liquid overfill when designing the knockout drum, collection headers, etc. The design of the disposal system shall prevent the discharge of liquids above their flash point directly to atmosphere (into the air or on the ground) if there is an unacceptable risk of a vapor cloud explosion or other hazardous condition. See 5.8.2.4 for cautions regarding the atmospheric discharge of liquids. See 5.2 regarding options for the disposal of liquids.

4.4.7.2 Mitigation Measures

When designing the system to mitigate liquid overfill, the following can affect the design and shall be evaluated:

- a) risk of failure of the operator to respond properly;
- b) operator training and operating procedures that include the expected response of instrumentation;

EXAMPLE A differential pressure or displacer-level measurement will read low compared to actual level if the fluid-specific gravity is less than the design-specific gravity. This can mean that the indicated level cannot reach 100 % even if the actual level is well above the measured range.
- c) availability of instrumentation that is required for adequate operator intervention;
- d) availability of instrumentation that is required for SIS response;
- e) potential consequence associated with relief stream disposition (e.g. discharge back into the process, discharge to atmosphere, discharge to a treatment system such as flare, etc.);
- f) the pressure design code requirements.

If operator intervention and/or SIS options are selected, then a risk analysis method shall determine the adequacy of the protection.

4.4.7.3 Level Instruments

Some criteria to consider when evaluating level instrumentation and alarms to demonstrate availability and independence from the basic process control system include the following:

- a) whether the level instruments used for safeguards against overfilling are on separate process taps from the process control system;
- b) whether level instruments used for safeguards against overfilling are susceptible to the same common mode device failures as those used for the basic process control system; diverse instrumentation can minimize the potential for common-mode device failures (e.g. differential pressure and radar, displacer and float, etc.);
- c) whether the programmable level transmitter is set to show a low or zero level when the level exceeds the instrument range;
- d) whether an open system differential pressure cell is used that can show a false low level due to accumulation of liquid in the upper impulse line if it is overfilled or collects condensed liquid;
- e) whether density changes due to temperature effects or composition changes impact readings from differential pressure transmitters;
- f) whether the instruments are proven in use for the specific process applications;
- g) whether the range of at least one of the level measurement(s) can indicate a valid level reading over the full range between the high critical alarm point and any shutdown or interlock point;
- h) whether operating characteristics of the level measurement during off-design, start-up, and shutdown operations are considered in display of level, physical properties, setting alarms, trip points, operator training, and operating procedures;
- i) maintenance and testing frequency required for the instrumentation.

4.4.8 Failure of Automatic Controls

4.4.8.1 General

Automatic control devices directly actuated from the process or indirectly actuated from a process variable (e.g. pressure, flow, liquid level, or temperature) are used at inlets and outlets of vessels or systems. When the transmission signal or operating medium to a final control element (such as a valve operator) fails, the control devices should assume either a fully open or fully closed position according to their basic design. Final control elements that fail in a stationary position should be assumed to fail fully open or fully closed (see 4.4.8.5). The failure of a process-measuring element in a transmitter or controller without coincidental failure of the operating power to the final controlled element should be reviewed to determine the effect on the final controlled element. Operation of the manual bypass valve is discussed in 4.4.8.3. Possible failure of the control device while the manual bypass valve is fully or partially open deserves to be considered; however, this factor is not intended to cover the condition of an undersized control valve.

In evaluating relief considerations, the designer should assume proper sizing of the control valve and unit operation at or near design unless a specific condition exists to the contrary. The designer should be alert to temporary start-up or upset conditions when unit operators are using the control valve's bypass valve. Since these are upset and off-control conditions, the probability that relieving requirements will arise is usually greater than when the unit is running normally under control with all bypasses closed.

4.4.8.2 Capacity Credit

In evaluating relieving requirements due to any cause, any automatic control valves that are not under consideration as causing a relieving requirement and that would tend to relieve the system should be assumed to remain in the position required for minimum normal processing flow. In other words, no credit should be taken for any favorable instrument response. Minimum normal valve position is the expected position of the valve prior to the upset incident, that is, the position of the valve when at minimum design flow rates (unit turndown conditions). Therefore, unless the condition of flow through the control valves changes (see 4.4.8.7), credit can be taken for the normal minimum flow of these valves, corrected to relieving conditions, provided that the downstream system is capable of handling any increased flow. Although controllers actuated by variables other than the system pressure can try to open their valves fully, credit can be taken for such control valves only to the extent permitted by their operating position at normal minimum flow regardless of the valve's initial condition.

4.4.8.3 Inlet Control Devices and Bypass Valves

There can be single or multiple inlet lines fitted with control devices. The scenario to consider is that one inlet valve is in a fully opened position regardless of the control valve failure position. Opening of this control valve can be caused by instrument failure or misoperation. If the system has multiple inlets, the position of any control device in those remaining lines shall be assumed to remain in its normal operating position. Therefore, the required relieving rate is the difference between the maximum expected inlet flow and the normal outlet flow, adjusted for relieving conditions and considering unit turndown, assuming that the other valves in the system are still in operating position at normal flow (i.e. normally open, normally closed, or throttling). If one or more of the outlet valves are closed, or more inlet valves are opened by the same failure that caused the first inlet valve to open, the required relieving rate is the difference between the maximum expected inlet flow and the normal flow from the outlet valves that remain open. All flows should be calculated at relieving conditions. An important consideration is the effect of having a manual bypass on the inlet control valve(s) at least partially open. If, during operation, the bypass valve is opened to provide additional flow, then this total flow (control valve wide open and bypass valve normal position) shall be considered in the relieving scenario.

The potential for the bypass valve to be inadvertently opened (e.g. during normal operations, control valve maintenance, start-up, shutdown, or special operations) while the control valve is operating (both bypass and control valve wide open) should also be considered. Administrative controls can be used to prevent inadvertent opening of the bypass valve, subject to 4.2.1 and 4.2.2. The user is cautioned that some systems can have unacceptable risk due to failure of administrative controls and resulting consequences due to loss of containment. In these cases, limiting the overpressure to the normally allowable overpressure can be more appropriate. Note that the entire system, including all of the auxiliary devices (e.g. gasketed joints, instrumentation), should be considered for the overpressure during the failure of administrative controls.

Other situations can arise where problems involved in evaluating relief requirements after the failure of an inlet control device are more complex and of special concern (e.g. a pressure vessel operating at a high pressure where liquid bottoms are on level control and discharge into a lower-pressure system). Usually, when the liquid is let down from the high-pressure vessel into the low-pressure system, only the flashing effect is of concern in the event that the low-pressure system has a closed outlet. However, the designer should also consider that vapors flow into the low-pressure system if loss of liquid level occurs in the vessel at higher pressure. In this case, if the volume of the source of incoming vapors is large compared with the volume of the low-pressure system or if the source of vapor is unlimited, serious overpressure can rapidly develop. When this occurs, it can be necessary to size relief devices on the low-pressure system to handle the full vapor flow through the liquid control valve. The loss of liquid level followed by high-pressure vapor flow is commonly referred to as "vapor breakthrough" or "gas blowby." Annex G provides additional considerations to evaluate the impact of the "vapor breakthrough" or "gas blowby" on low-pressure system and overpressure relief requirements.

In circumstances where process systems involve significant differences in pressure level and the volume of vapor contained by the high-pressure equipment is less than the volume of the low-pressure system, the additional pressure can, in some cases, be absorbed without overpressure.

In the event of loss of liquid level, the vapor flow into the low-pressure system depends on what the interconnecting system, which usually consists of wide-open valves and piping, passes with a differential pressure based on the normal operating pressure upstream and the relieving pressure on equipment downstream. The user is cautioned

that a higher upstream pressure should be used if it occurs coincident with loss of liquid level. This pressure drop at initial conditions frequently results in critical flow (choking across a control valve) and can cause the rate to be several times higher than the normal rate of vapor inflow to the high-pressure system. Unless makeup equals outflow, this condition is of short duration as the upstream reservoir is depleted. Nonetheless, the relief facilities that protect the low-pressure system shall be sized to handle the peak flow. If the low-pressure side has a large vapor volume, it can prove worthwhile to take credit for the following: The transfer of vapors from the high-pressure system needed to raise the pressure on the downstream side from operating pressure to relieving pressure (normally 110 % of design pressure or MAWP) lowers the upstream pressure. This decrease produces a corresponding reduction in the flow that establishes the relieving requirement. Where such credit is taken, an allowance shall be made for the normal makeup of vapor to the high-pressure system that tends to maintain upstream pressure. The vapor breakthrough flow rate can also be reduced by, for example, the use of a smaller valve, reduced trim, mechanical stop, or an orifice restriction in the flow path.

See 4.4.17 for additional guidance concerning piping design for cases with potential vapor breakthrough.

4.4.8.4 Outlet Control Devices

Each outlet control valve should be considered in both the fully opened and the fully closed positions for the purposes of relief load determination. This is regardless of the control valve failure position because failure can be caused by instrument system failure or misoperation. If one or more of the inlet valves are opened by the same failure that caused the outlet valve to close, PRDs can be required to prevent overpressure. The required relieving rate is the difference between the maximum inlet and maximum outlet flows. All flows should be calculated at relieving conditions. Also, one should consider the effects of inadvertent closure of control devices by operator action.

For applications involving single outlets with control devices that fail in the closed position, PRDs can be required to prevent overpressure. The required relieving rate is equal to the maximum expected inlet flow at relieving conditions and should be determined as outlined in 4.4.2.4.

For applications involving more than one outlet and a control device that fails in the closed position on an individual outlet, the required relieving rate is the difference between the maximum expected inlet flow and the design flow (adjusted for relieving conditions and considering unit turndown) through the remaining outlets, assuming that the other valves in the system remain in their normal operating position.

For applications involving more than one outlet, each with control devices that fail in the closed position because of the same failure, the required relieving rate is equal to the maximum expected inlet flow at relieving conditions.

4.4.8.5 Fail-stationary Valves

Even though some control devices are designed to remain stationary in the last controlled position, one cannot predict the position of the valve at time of failure. Therefore, the designer should always consider that such devices could be either open or closed: no reduction in required relieving rate should be considered when such devices are used.

4.4.8.6 Choke Valve Failure

Experience has shown that, under certain conditions and in certain services, choke valves may be subject to a sudden and complete failure of the valve trim, leading to a dramatic increase in the valve's flow capacity. Such a failure may lead to a sustained flow that is substantially larger than normal flow. The design flow should include the additional flow arising from a single failed choke as the worst-case flow for overpressure calculations and system response requirements. A dynamic analysis may be required to determine these effects (see 4.3.3). The user should determine whether choke valve collapse is a basis for design or not credible.

Production chokes [e.g. subsea choke, topside (riser) choke, wellhead choke] may be subject to a collapse and subsequent sudden increase in flow capacity. Among the possible causes are:

- a) impact by solids from the formation (e.g. during a well cleanup or well start-up);

- b) impact by fragments of tools/devices from the well;
- c) erosion/corrosion;
- d) mechanical fatigue;
- e) brittle fracture.

Measures to consider for mitigating the consequences of a choke failure include:

- a) pressure-relief device;
- b) replacing a large valve with multiple smaller valves, as it is necessary to consider only one choke valve failure at a time;
- c) the user may define choke failure as not credible based on selection of high-integrity choke designs; such a conclusion should be substantiated by a careful analysis of the nature and characteristics of mechanical loads and/or a program for testing and qualification;
- d) use of dedicated choke valves or change of choke trim for special operations in which solids are expected, such as well cleanup;
- e) restrictions (e.g. perforated plate) in the flow path that will serve to limit the maximum mechanical load caused by impacts.

The user should avoid rapid opening of the choke valve and carefully evaluate the need for regular inspection and maintenance programs for the choke valves.

4.4.8.7 Special Capacity Considerations

Although control devices, such as diaphragm-operated control valves, are specified and sized for normal design operating conditions, they are also expected to operate during upset conditions, including periods when PRDs are relieving. Valve design and valve operator capability should be selected to position the valve plug properly in accordance with control signals during abnormal conditions. Because the control valve capacities at pressure-relieving conditions are not the same as those at normal conditions, the control valve capacities should be calculated for the relieving conditions of temperature and pressure in determining the required relieving rates. In extreme cases, the state of the controlled fluid can change (e.g. from liquid to gas or from gas to liquid). The wide-open capacity of a control valve selected to handle a liquid can, for example, differ greatly when it handles a gas. This becomes a matter of particular concern where loss of liquid level can occur, causing the valve to pass high-pressure gas to a system sized to handle only the vapor flashed from the normal liquid entry. This is the vapor breakthrough scenario described in 4.4.8.3.

4.4.9 Abnormal Process Heat or Vapor Input

4.4.9.1 Abnormal Process Heat Input

Reboilers and other process heating equipment are designed with a specified heat input. When they are new or recently cleaned, additional heat input above the normal design can occur. In the event of a failure of temperature control, vapor generation can exceed the process system's ability to condense or otherwise absorb the buildup of pressure, which may include noncondensables caused by overheating.

The required relieving rate is the maximum rate of vapor generation at relieving conditions (including any noncondensables produced from overheating) less the rate of normal condensation or vapor outflow. In every case, the designer should consider the potential behavior of the system and each of its components. For example, the fuel or heat-medium control valve or the tube heat flux can be the limiting consideration. To be consistent with the practice used for other causes of overpressure, design values should be used for an item such as control valve size.

However, built-in overcapacity, which is applicable to the common practice of specifying burners capable of 125 % of heater design heat input, shall be considered.

If limit stops are installed on control valves, the wide-open capacity, rather than the capacity at the stop setting, should normally be used. However, if a mechanical stop is installed and is adequately documented, use of the limited capacity can be appropriate. In shell-and-tube heat exchange equipment, heat input should be calculated on the basis of clean, rather than fouled, conditions.

4.4.9.2 Inadvertent Valve Opening

The inadvertent opening of any valve from a source of higher pressure, such as high-pressure steam or process fluids, should be considered. Administrative controls can be used to prevent inadvertent valve opening, subject to 4.2.1 and 4.2.2. The relief load should be determined using the maximum operating pressure upstream of the valve and the relieving pressure on equipment downstream of the valve. If the pressure source is a pipeline or a production well, the pressure upstream of the valve may reach the maximum shut-in pressure of the source after a shutdown. The user should determine whether inadvertent valve opening combined with maximum shut-in pressure in upstream system is a credible relief case.

The following applies when a manual or actuated valve is inadvertently opened, causing pressure buildup in a vessel. The vessel should have a PRD large enough to pass a rate equal to the flow through the open valve; credit may be taken for the flow capacity of vessel outlets that can reasonably be expected to remain open. The manual or actuated valve should be considered as passing its capacity at a full-open position with the pressure in the vessel at relieving conditions. Volumetric or heat-content equivalents may be used if the manual or actuated valve admits a liquid that flashes or a fluid that causes vaporizing of the vessel contents. It is typical to consider only one inadvertently opened manual or actuated valve at a time, although simultaneous inadvertent opening of multiple valves shall be considered if a common cause is identified (e.g. sequential valve operations). Automatic control failures are discussed separately in 4.4.8.

See 4.4.17 for additional guidance concerning piping design for cases with inadvertent valve opening.

4.4.9.3 Check Valve Leakage or Failure

4.4.9.3.1 General

Check valves are intended to limit reverse flow but these are not an effective means for preventing overpressure by reverse flow because check valves can leak or can fail. For example, if a fluid is pumped into a system that contains vapor at significantly higher pressure than the design rating of the equipment upstream of the pump, loss of pumped flow with leakage or failure of a check valve in the discharge line results in a reversal of the liquid's flow. This flow reversal could result in overpressure. This standard describes the following three reverse flow conditions and when these should be considered.

- a) Complete check valve failure—Potential for gross reverse flow because the check valve does not function at all (e.g. it is stuck wide open or the internals are gone).
- b) Severe check valve leakage—Potential for significant reverse flow because of check valve seat damage or obstruction.
- c) Normal check valve leakage—Potential for minor reverse flow due to normal check valve wear.

4.4.9.3.2 Overpressure Due to Reverse Flow Considerations

4.4.9.3.2.1 Normal Check Valve Leakage

The potential to overpressure piping or equipment due to a blocked- in condition and normal check valve leakage should be considered. Potential overpressure can be avoided by specifying higher design pressures, may be managed using administrative controls, subject to 4.2.1 and 4.2.2, or may be mitigated by providing pressure relief. If the design includes a PRD, it is up to the user to determine how to size this device.

Administrative controls may be effective in some scenarios but not effective in others, even for the same equipment. For example, while lining up a spare pump, administrative controls may be effective in preventing overpressure caused by reverse flow across the check valve caused by opening the discharge valve before the pump is started. However, administrative controls would not be effective at preventing reverse flow across the check valve if the same pump stops during normal operation.

4.4.9.3.2.2 Severe Check Valve Leakage

In addition to the normal check valve leakage case, consideration should be given to the more severe case where reverse flow may occur through one or more check valves in series. Where the maximum operating pressure of the high-pressure system is greater than the low-pressure equipment's corrected hydrotest pressure (see 3.1.19 and 4.2.2), consider additional risk reduction beyond administrative controls. Note that the entire low-pressure system, including vessels, piping and auxiliary devices (e.g. gasketed joints, instrumentation), should be considered for the overpressure scenario.

For certain rotating equipment such as reciprocating compressors and positive displacement pumps, the user may determine that significant reverse flow through the machinery will not occur. Overpressure due to normal check valve leakage should still be considered. If a recycle line is installed downstream of such equipment, then significant reverse flow is a potential due to opening of the recycle valve.

In most cases, focus should be on prevention of reverse flow. It is important to note that, in addition to overpressure of the upstream system, reverse flow through machinery can damage rotating equipment, potentially causing loss of containment. Additional means of reverse flow prevention should be provided.

Experience has shown that two reverse flow prevention devices in series are typically sufficient to eliminate significant reverse flow when these are tested or internally inspected and maintained to demonstrate reliability. As the differential pressure increases, the use of additional safeguards should be considered to reduce the risk of check valve failures that could lead to mechanical equipment damage and/or loss of containment. The user might want to consider dissimilar reverse flow prevention devices (e.g. swing check and a piston check valve). For two or more check valves in series that are internally inspected and maintained to demonstrate reliability, only normal check valve leakage may be assumed.

4.4.9.3.3 Calculation of Reverse Flow Through Failed Check Valves

Complete check valve failure is assumed for all check valves in series that are not inspected and maintained and for a single check valve regardless if it is inspected and maintained. The following assumptions may be made to estimate the reverse flow through a failed check valve (select one):

- a) the failed check valve has no flow resistance in the reverse flow direction;
- b) the failed check valve has the same flow resistance in the reverse flow direction as in the forward flow direction;
- c) the failed check valve is equivalent to an orifice equal to the check valve flow area without internals.

For check valves that are internally inspected and maintained but reliability does not meet the user's risk criteria, it will be necessary to estimate the reverse flow. The severity of reverse flow through these check valves depends on the following:

- a) the rigor and experience with the user's check valve inspection/maintenance program;
- b) the types of check valves;
- c) the fouling nature of the fluid;
- d) the materials of construction;
- e) whether the service is pulsating;
- f) other system considerations.

Therefore, it is the responsibility of the user to determine an appropriate technique for estimating the reverse flow. Where no specific experience or company guidelines exist, the following approach may be used.

- a) Where multiple check valves in series are inspected and maintained, assume the smallest check valve has completely failed and all other inspected and maintained check valves have severe leakage. Because of potential common mode failures the user is cautioned against taking a larger credit for more than two check valves in series that are inspected and maintained.

There are widely differing practices to estimate reverse flow with an inspected and maintained check valve that has severe leakage. It is up to the user to determine how to estimate. Two practices are presented below.

- 1) Treat the check valve as an orifice with a diameter equal to 10 % of the check valve's nominal flow diameter (i.e. orifice area equal to 1 % of the nominal flow area). The reverse flow is calculated using the orifice area, the relief fluid properties, the maximum operating pressure on the side normally downstream of the check valve, and the allowable accumulation on the side normally upstream of the check valve.
 - 2) Treat the check valve as an orifice that is sized to pass 10 % of the normal forward flow. The orifice area is calculated using the normal fluid properties, maximum operating pressure on the upstream side of the check valve, and the maximum operating pressure on the downstream side of the check valve. To determine the reverse flow rate, this orifice is then rated using the relief fluid properties, the maximum operating pressure on the side normally downstream of the check valve, and the allowable accumulation on the side normally upstream of the check valve.
- b) The pressures used on each side of the "orifice" can reflect credit for pressure drop in the piping, valves, and equipment. The hydraulics profile should be based on the high-pressure side at maximum operating pressure and the low-pressure side at allowable accumulation. The hydraulic calculations should take into account the effect of fluid phase change during the reverse flow when applicable (e.g. reverse vapor breakthrough).

4.4.9.4 Reciprocating Compressor Rod Packing Failure

Reciprocating compressors should be protected from rod packing failures in the distance piece by an adequately sized vent line or PRD. Options to size the PRD or vent line can include the following:

- a) determine the annular gap between the compressor rod and packing gland and calculate flow using an equivalent square edge orifice area, or
- b) provide a PRD with inlet size equal to the nominal pipe size (NPS) of the vent piping.

An alarm may be provided to indicate to operators that there is abnormally high packing leak off rate (e.g. a high-temperature alarm or a high-pressure alarm).

4.4.10 Internal Explosions or Transient Pressure Surges

4.4.10.1 Internal Explosion (Excluding Detonation)

If overpressure protection is to be provided against internal explosions caused by ignition of vapor-air mixtures where the flame speed is subsonic (i.e. deflagration but not detonation), rupture disks or explosion vent panels, not relief valves, should be used. These devices respond in milliseconds. In contrast, relief valves react too slowly to protect the vessel against the extremely rapid pressure buildup caused by internal flame propagation. The vent area required is a function of a number of factors including the following:

- a) initial conditions (pressure, temperature, composition);
- b) flame propagation properties of the specific vapors or gases;
- c) volume of the vessel;

- d) pressure at which the vent device activates;
- e) maximum pressure that can be tolerated during a vented explosion incident.

It should also be noted that the peak pressure reached during a vented explosion is usually higher, sometimes much higher, than the pressure at which the vent device activates.

Design of explosion-relief systems should follow recognized guidelines such as those contained in NFPA 68 ^[125]. Simplified rules-of-thumb should not be used as these can lead to inadequate designs. If the operating conditions of the vessel to be protected are outside the range over which the design procedure applies, explosion vent designs should be based on specific test data, or an alternate means of explosion protection should be used.

Some alternate means of explosion protection are described in NFPA 69 ^[126], including explosion containment, explosion suppression, oxidant-concentration reduction, and so forth.

Explosion-relief systems, explosion containment, and explosion suppression should not be used for cases where detonation is considered a credible risk. In such cases, the explosion hazard should be mitigated by preventing the formation of mixtures that could detonate.

Explosion prevention measures, such as inert gas purging, in conjunction with suitable administrative controls can be considered in place of explosion-relief systems for equipment in which internal explosions are possible only as a result of air contamination during start-up or shutdown activities.

4.4.10.2 Transient Pressure Surges

4.4.10.2.1 Water Hammer

The probability of hydraulic shock waves, known as water hammer, occurring in any liquid-filled system should be carefully evaluated. Water hammer is a type of overpressure that cannot be controlled by typical PRVs, since the response time of the valves can be too slow. The oscillating pressure peaks, measured in milliseconds, can raise the normal operating pressure by many times. These pressure waves damage the pressure vessels and piping where proper safeguards have not been incorporated. Water hammer is frequently avoided by limiting the speed at which valves can be closed in long pipelines. Where water hammer can occur, the use of pulsation dampeners, special bladder-type accumulators, or surge valves should be considered, contingent on proper analysis.

4.4.10.2.2 Steam Hammer

An oscillating peak-pressure surge, called steam hammer, can occur in piping that contains compressible fluids. The most common occurrence is generally initiated by rapid valve closure. This oscillating pressure surge occurs in milliseconds, with a possible pressure rise in the normal operating pressure by many times, resulting in vibration and violent movement of piping and possible rupture of equipment. PRVs cannot effectively be used as a protective device because of their slow response time. Avoiding the use of quick-closing valves can prevent steam hammer.

4.4.10.2.3 Condensate-induced Hammer

Isolation of a steam bubble by cold condensate can lead to the eventual rapid collapse of the bubble and catastrophic damage to steam pipework. Proper design and operation of the process system are essential in attempts to eliminate this possibility [e.g. by the use of drains, steam traps, appropriate pipe slope, training, and careful management of change (MOC)].

The hazard is particularly acute during turnaround and maintenance activities where dead-legs that trap a steam bubble can be inadvertently created. PRDs cannot effectively be used as a protective device.

4.4.11 Chemical Reaction

4.4.11.1 General

In some reactions and processes, loss of process control can result in a significant change in temperature and/or pressure. The result can exceed the intended limits of the materials selected. Thus, where cryogenic fluids are being processed, a reduction in pressure could lower the temperature of the fluids to a level below the minimum allowable design temperature of the equipment, with the attendant risk of a low-temperature brittle failure. For exothermic reactions (e.g. decompositions, acid dilutions, polymerizations), excessive temperatures and/or pressures associated with runaway reactions can reduce the allowable stress levels below the design point, or increase the pressure above the MAWP. Where normal PRDs cannot protect against these situations, controls are necessary to warn of changes outside the intended temperature/pressure limits to provide corrective action (see 4.4.8 and 4.4.9). The potential for a chemical reaction in conjunction with the other overpressure scenarios in 4.4 should be considered when appropriate.

The methodology for determining the appropriate size of an emergency vent system for chemical reactions has been established by the Design Institute for Emergency Relief Systems (DIERS) [67, 69, 75, 106, 107] and API 520, Part 1.

The DIERS methodology is based on the following:

- a) defining the design basis upset conditions for the reaction system;
- b) characterizing the systems through bench-scale tests simulating the design basis upset conditions;
- c) using vent-sizing equation that accounts for two-phase gas/liquid vent flow.

4.4.11.2 Scenarios

The design basis upset conditions are process specific but generally include one or more of the following:

- a) external fire;
- b) loss of mixing;
- c) loss of cooling;
- d) incorrect charge of reagents.

4.4.11.3 Reaction Rates/Sizing

Reaction rates are rarely known; therefore, bench-scale tests simulating the design basis upset condition are usually required. There are a number of test apparatus available for this purpose. With the information obtained from the bench-scale tests, the system can be characterized by one of the following terms.

- **Tempered:** Tempered systems are those in which the unwanted reaction produces condensable products and the rate of temperature rise is tempered by liquid boiling at system pressure. Typically, tempered systems are liquid-phase reactions in which a reactant (or solvent) is a major portion of the reactor contents.
- **Gassy:** Gassy systems are those in which the unwanted reaction produces noncondensable products and the rate of temperature rise is not tempered by boiling liquid. Gassy systems can be either liquid-phase decompositions or vapor-phase reactions.
- **Hybrid:** Hybrid systems are those in which the rate of temperature rise due to an unwanted reaction can be tempered by liquid boiling at system pressure but can also give rise to the generation of noncondensable gas.

Following characterization of the system, the appropriate vent-sizing equation can be selected. An excellent discussion of these procedures is contained in Grolmes et al. [75]. However, the reader should be cautioned that this is an area with rapidly changing technology and the most current technology should be used, if available.

If the bench-scale simulations indicate the potential for an explosion, the considerations in 4.4.10 should be applied. It can also be prudent to consider housing the reactor in a specially constructed bay to handle potentially explosive reactions or to increase the equipment-design conditions to contain maximum expected temperature and pressure.

Where feasible, a PRD should be used to control overpressure. Where this is infeasible, other design strategies can be employed to control equipment overstressing. These strategies can include using safety systems such as automatic shutdown systems, inhibitor injection, quench, de-inventorying, alternative power supplies, and depressuring. When this approach is taken, the reliability of the protective system(s) should be addressed in a formal risk analysis. This analysis is outside the scope of this standard.

Other forms of reactions that generate heat (dilution of strong acids) should also be evaluated.

4.4.12 Hydraulic Expansion

4.4.12.1 Causes

Hydraulic expansion is the increase in liquid volume caused by an increase in temperature (see Table 2). It can result from several causes, the most common of which are the following.

- a) Piping or vessels are blocked in while they are filled with cold liquid and are subsequently heated by heat tracing, coils, ambient heat gain, or fire.
- b) A heat exchanger is blocked in on the cold side with flow in the hot side.

Caution—Block valves have the potential to leak, thereby admitting either cold or hot fluid into a heat exchanger that is intended to be blocked in, resulting in a potential overpressure.

- c) Piping or vessels are blocked in while they are filled with liquid at near-ambient temperatures and are heated by direct solar radiation.

Table 2—Typical Values of Cubic Expansion Coefficient for Hydrocarbon Liquids and Water

Gravity of Liquid °API	Cubic Expansion Coefficient ^a 1/°C (1/°F)
3 to 34.9	0.00072 (0.0004)
35 to 50.9	0.0009 (0.0005)
51 to 63.9	0.00108 (0.0006)
64 to 78.9	0.00126 (0.0007)
79 to 88.9	0.00144 (0.0008)
89 to 93.9	0.00153 (0.00085)
94 and lighter	0.00162 (0.0009)
Water	0.00018 (0.0001)

^a At 15.6 °C (60 °F); for other temperatures, Equation (5) can be used to estimate the cubical expansion coefficient.

In certain installations, such as cooling water circuits, the processing scheme, equipment arrangements and methods, and operation procedures make the elimination of the hydraulic expansion as a cause of overpressure feasible. Typical of such conditions are multiple-shell heat exchangers with at least one cold-fluid block valve of the locked-open design on each shell and a single-shell unit in a given service where the shell can reasonably be expected to remain in service, except on shutdown. In this instance, closing the cold-fluid block valves on the heat exchanger unit should be controlled by administrative procedures and possibly the addition of signs stipulating the proper venting and draining procedures when shutting down and blocking in. The designer is cautioned to review each installation before deciding that administrative controls can be used to eliminate hydraulic expansion as a cause of overpressure. For example, an isolation valve can leak on an isolated heat exchanger or piping containing cold fluid can be blocked-in by a control or shutdown system. If overpressure by thermal hydraulic expansion is deemed credible, a PRD should be designed and installed per the guidelines provided in the following sections.

Caution—When hydraulic expansion overpressure is caused by expansion of sub-cooled liquid, the relief rates are typically relatively small, requiring relatively small PRDs. If the trapped liquid can be heated above its bubble point temperature at the relief pressure, vaporization can occur when the fluid is still contained causing potential loss of containment with possible boiling liquid expanding vapor explosion (BLEVE) unless a significantly larger PRD is installed to protect the equipment from overpressure. See 4.4.13.2.5.3 for guidance.

Caution—In some cases, the contained fluid can be heated above its SLT. In such cases, experience has shown that equipment failure due to thermal hydraulic expansion can result in a BLEVE instead of a minor flange release. See 4.4.6 for a discussion of the SLT.

4.4.12.2 Sizing and Set Pressure

The required relieving rate is not easy to determine. Since every application is for a relieving liquid, the required relieving rate is small; specifying an oversized device is, therefore, reasonable. A nominal diameter (DN) 20 × DN 25 (NPS ¾ × NPS 1) relief valve is commonly used. If there is reason to believe that this size is not adequate, the procedure in 4.4.12.3 can be applied. If the liquid being relieved is expected to flash or form solids while it passes through the relieving device, the procedure in 4.9.2 is recommended.

Proper selection of the set pressure for these relieving devices should include a study of the design rating of all items included in the blocked-in system. The thermal-relief pressure setting should never be above the maximum pressure permitted by the weakest component in the system being protected. However, the PRD should be set high enough to open only under hydraulic expansion conditions. If thermal-relief valves discharge into a closed system, the effects of backpressure should be considered.

4.4.12.3 Special Cases

Two general applications for which thermal-relieving devices larger than a DN 20 × DN 25 (NPS 3/4 × NPS 1) valve can be required are long pipelines of large diameter in uninsulated, aboveground installations and large vessels or heat exchangers operating liquid-full. Long pipelines can be blocked in at or below ambient temperature; the effect of solar radiation raises the temperature at a calculable rate. If the total heat transfer rate and thermal expansion coefficient for the fluid are known, a required relieving rate can be calculated. See Parry^[135] for additional information on thermal relief.

If the fluid properties vary significantly with temperature, the worst-case temperature should be used. Alternatively, more sophisticated calculation methods that include temperature-dependent fluid properties can be used to optimize the size of the relief device.

For liquid-full systems, expansion rates for the sizing of relief devices that protect against thermal expansion of the trapped liquids can be approximated using Equation (2) in International System (SI) of units or Equation (3) in US customary (USC) units:

$$q = \frac{\alpha_v \times \phi}{1000d \times c} \quad (2)$$

where

q is the volume flow rate at the relieving conditions, expressed in m³/s;

α_v is the cubic expansion coefficient for the liquid at the relieving conditions, expressed in 1/°C;

NOTE This information is best obtained from the process design data; however, Table 2 shows typical values for hydrocarbon liquids and water at 15.6 °C.

ϕ is the total heat transfer rate, expressed in watts;

NOTE For heat exchangers, this can be taken as the maximum heat exchanger duty during operation.

d is the relative density referred to water ($d = 1.00$ at 15.6 °C), dimensionless;

NOTE Compressibility of the liquid is usually ignored.

c is the specific heat capacity of the trapped fluid, expressed in J/kg·K;

1000 is the density of water at 15.6 °C, expressed in kg/m³.

$$q = \frac{\alpha_v \times \phi}{500d \times c} \quad (3)$$

where

q is the volume flow rate at the relieving conditions, expressed in US gallons per minute;

α_v is the cubic expansion coefficient for the liquid at the relieving conditions, expressed in $1/^\circ\text{F}$;

NOTE This information is best obtained from the process design data; however, Table 2 shows typical values for hydrocarbon liquids and water at 60°F .

ϕ is the total heat transfer rate, expressed in Btu/h;

NOTE For heat exchangers, this can be taken as the maximum heat exchanger duty during operation.

d is the relative density referred to water ($d = 1.00$ at 60°F), dimensionless;

NOTE Compressibility of the liquid is usually ignored.

c is the specific heat capacity of the trapped fluid, expressed in $\text{Btu}/\text{lb}\cdot^\circ\text{F}$;

$500 = 0.13368 \text{ ft}^3/\text{gallon} \times 60 \text{ min/h} \times 62.366 \text{ lb}/\text{ft}^3$ (water density at 60°F).

This calculation method provides only short-term protection in some cases. If the blocked-in liquid has a vapor pressure higher than the relief design pressure, then the PRD should be capable of handling the vapor-generation rate. If discovery and correction before liquid boiling is expected, then it is not necessary to account for vaporization in sizing the PRD.

4.4.12.4 Piping

4.4.12.4.1 Theoretical Background for Rigorous Calculations

Where the system under consideration for thermal relief consists of piping only (does not contain pressure vessels or heat exchangers), a PRD might not be required to protect piping from thermal expansion if any of the following apply:

a) the piping always contains a pocket of noncondensing vapor, such that it can never become liquid-full; or

Caution—Small vapor or gas pockets can disappear upon heating due to compression and/or solubilization. In contrast, multicomponent mixtures with a wide boiling range can always have sufficient vapor present to preclude becoming completely liquid-full. The liquid-volume change upon solar heating, heat tracing, heating to ambient temperature, or heat from another source should be estimated to determine if the volume of the vapor pocket is sufficient for liquid expansion.

b) the piping is in continuous use (i.e. not batch or semicontinuous use) and drained after being blocked in using well supervised procedures or permits; or

c) the fluid temperature is greater than the maximum temperature expected from solar heating [usually approximately 60°C to 70°C (approximately 140°F to 160°F)] and there are no other heat sources such as heat tracing (note that fire is generally not considered when evaluating pressure-relief requirements for piping); or

d) the estimated pressure rise from thermal expansion is within the design limits of the equipment or piping.

The pressure rise due to simultaneous heating of the pipe and blocked-in liquid can be calculated from Equation (4) [Karcher ^[97] and the Center for Chemical Process Safety (CCPS) ^[42]]:

$$p_2 = p_1 + \frac{(T_2 - T_1)(\alpha_v - 3\alpha_l) - \left(\frac{q_{ll} \times t}{V}\right)}{\chi + \left(\frac{d}{2E \times \delta_w}\right)(2.5 - 2\mu)} \quad (4)$$

where

- p_2 is the final gauge pressure of blocked-in, liquid-full equipment, expressed in kPa (psig);
- p_1 is the initial gauge pressure of blocked-in, liquid-full equipment, expressed in kPa (psig);
- T_2 is the final temperature of blocked-in, liquid-full equipment, expressed in °C (°F);
- T_1 is the initial temperature of blocked-in, liquid-full equipment, expressed in °C (°F);
- α_v is the cubic expansion coefficient of the liquid, expressed in 1/°C (1/°F);
- α_l is the linear expansion coefficient of metal wall, expressed in 1/°C (1/°F);
- χ is the isothermal compressibility coefficient of the liquid, expressed in 1/kPa (1/psi);
- d is the internal pipe diameter, expressed in m (in.);
- E is the modulus of elasticity for the metal wall at T_2 , expressed in kPa (psi);
- δ_w is the metal wall thickness, expressed in m (in.);
- μ is Poisson's ratio, usually 0.3;
- q_{ll} is the liquid leakage rate across the block valve seat (usually taken as 0), expressed in m³/s (in.³/s);
- t is the elapsed time for leakage, expressed in seconds;
- V is the pipe volume, expressed in m³ (in.³).

Selected data for α_l and E are given in Table 3. See *Perry's Chemical Engineers' Handbook* [136] for data on other materials.

Table 3—Values of Linear Expansion Coefficient, α_l , and Modulus of Elasticity, E

Metal	α_l 1/°C (1/°F)	E kPa (psi)
Carbon steel (1020)	1.21×10^{-5} (6.7×10^{-6})	207×10^6 (30×10^6)
304 stainless steel	1.73×10^{-5} (9.6×10^{-6})	193×10^6 (28×10^6)
316 stainless steel	1.60×10^{-5} (8.9×10^{-6})	193×10^6 (28×10^6)
Alloy 600	1.1×10^{-5} to 1.66×10^{-5} (6.1×10^{-6} to 9.2×10^{-6})	172×10^6 to 221×10^6 (25×10^6 to 32×10^6)
Nickel-copper alloy	1.01×10^{-5} to 1.42×10^{-5} (5.6×10^{-6} to 7.9×10^{-6})	169×10^6 to 213×10^6 (24.5×10^6 to 30.9×10^6)

Where data are unavailable, Equation (5) and Equation (6) can be used to estimate, respectively, the isothermal compressibility coefficient, χ (see *Lange's Handbook of Chemistry*, Twelfth Edition^[51], pp. 10–122) and the cubic expansion coefficient, α_v (see *Perry's Chemical Engineers' Handbook*^[136], Fifth Edition, pp. 3–227):

$$\alpha_v = \frac{\rho_1^2 - \rho_2^2}{2(T_2 - T_1)\rho_1 \times \rho_2} \quad (5)$$

where

- α_v is the cubic expansion coefficient, expressed in 1/°C (1°F);
- ρ_1 is the density of liquid at temperature T_1 , expressed in kg/m³ (lb/ft³);
- ρ_2 is the density of liquid at temperature T_2 , expressed in kg/m³ (lb/ft³);
- T_1 is the temperature at the beginning of the interval, expressed in °C (°F);
- T_2 is the temperature at the end of the interval, expressed in °C (°F).

$$\chi = \frac{1}{v_1} \frac{(v_1 - v_2)}{(p_2 - p_1)} \quad (6)$$

where

- χ is the isothermal compressibility coefficient, expressed in 1/kPa (1/psi);
- v_1 is the specific volume of liquid at pressure p_1 , expressed in m³/kg (ft³/lb);
- v_2 is the specific volume of liquid at pressure p_2 , expressed in m³/kg (ft³/lb);
- p_1 is the absolute pressure at the beginning of the interval, expressed in kPa (psia);
- p_2 is the absolute pressure at the end of the interval, expressed in kPa (psia).

4.4.12.4.2 Other Aspects

For the thermal expansion scenario, no credit should be taken for reverse flow back through a check valve (i.e. assume the check valve holds) or a closed block valve. Alternatives are to drill a small [e.g. 6 mm (¹/₄ in.)] hole in the block valve gate, install a small bypass around the block valve with appropriate administrative controls, or install a three-way valve to ensure that the piping system cannot be completely blocked in.

If the above criteria cannot be met for a piping system, then the following factors should be evaluated for the fluid and the piping system, when determining if a thermal-relief valve is warranted to protect the system.

- a) Length and size of the piping system—The quantity of fluid that can be released is dependent on the length and size of the piping system.
- b) Hazardous and flammable nature of the fluid—For a hazardous or highly flammable fluid, even a small amount of leakage might not be allowable.
- c) Location of the piping system—Leakage into a confined area can be especially hazardous depending on the fluid properties.
- d) Vapor pressure of the fluid at the heated temperature—Fluids above their atmospheric boiling point continue to release material as vapor through a leak until the fluid temperature cools to the boiling point.
- e) Adequacy of procedures and administrative controls to avoid blocking in.

4.4.13 Fires

4.4.13.1 General

Fire exposure on equipment can result in overpressure due to vapor generation (boiling of liquid contents or decomposition reaction) and/or fluid expansion. Fire exposure can also cause overheating of the vessel walls resulting in a reduction in material strength. For the purpose of this standard, fires are characterized as open pool fires (see 4.4.13.2), confined pool fires (see 4.4.13.3), or jet fires (see 4.4.13.4). A pool fire typically results from an ignited liquid spill, whereas a jet fire results from an ignited pressurized leak. The heat flux from jet fires is very high and localized, whereas the heat flux from pool fires is lower and not localized. Confined pool fires are those that occur inside a structure or are confined by embankments thereby causing higher heat fluxes than open pool fires in some cases. Fire heat intensities can vary dramatically depending on fuel, ventilation, release rate, and other factors. Typical ranges of heat intensities are as follows.

- Open pool fire: 50 kW/m² to 150 kW/m² (15,850 Btu/h·ft² to 47,550 Btu/h·ft²).
- Confined pool fire: 100 kW/m² to 250 kW/m² (31,700 Btu/h·ft² to 79,250 Btu/h·ft²).
- Jet fire: 100 kW/m² to 400 kW/m² (31,700 Btu/h·ft² to 126,800 Btu/h·ft²).

Annex A describes fire scenarios in detail and provides guidance in modeling fires. This information may be useful for assessing fires that may have less intensity than that premised in 4.4.13.2 or may be used for purposes other than PRD sizing (e.g. for emergency depressuring). Caution should be taken when using the Annex A method for sizing PRDs because it may underestimate the fire heat input.

4.4.13.2 Open Pool Fires

4.4.13.2.1 General

For the purposes of PRD sizing for equipment within the scope of this standard, the design fire scenario has been and continues to be an open pool fire. The recommended method was empirically derived to size PRDs for open pool fires involving hydrocarbons in a refinery environment that is typical for the facilities within the scope of this standard. The method is supported by full-scale test data (see A.2 and C.6 for details).

Both API 521 and API 2000 ^[11] use open pool fires as the basis for sizing PRDs for the fire case. It is important to apply the appropriate standard when sizing for fire relief because there are differences in assumptions for the fire pool fire intensity, exposed area, and other factors specified in those standards. API 2000 is limited to aboveground liquid-petroleum or petroleum-products storage tanks and aboveground and underground refrigerated storage tanks designed for operation at gauge pressures from vacuum through 103.4 kPa (15 psi).

An open pool fire can affect multiple vessels simultaneously. See 5.3.2 for a discussion.

If the open pool fire involves other types of fuels (e.g. alcohols) that have significantly different radiative fluxes than fuels similar to gasoline, diesel, liquefied petroleum gas (LPG), etc., the method in Annex A can be used with adjusted variables (see Annex A for details).

Relieving temperatures are often above the design temperature of the equipment being protected. If the elevated temperature is likely to cause vessel rupture, additional protective measures should be considered (see 4.4.13.2.6 and 4.4.13.2.7).

4.4.13.2.2 Effect of Fire on the Wetted Surface of a Vessel

To determine vapor generation, it is necessary to recognize only that portion of the vessel that is wetted by its internal liquid and is equal to or less than 7.6 m (25 ft) above the source of flame.

NOTE Hydrocarbon fires can exceed 7.6 m (25 ft) in height; however, experience has shown that it is necessary only to size relief devices on the basis of the averaged heat input up to a height of 7.6 m (25 ft) above the base of a pool fire.

The term “base of a pool fire” usually refers to ground level but could be at any level at which a substantial spill or pool fire could be sustained. Various classes of vessels are operated only partially full. Table 4 gives recommended portions of liquid inventory for use in calculations. Wetted surfaces higher than 7.6 m (25 ft) are normally excluded because pool fire flames are not likely to impinge for long durations above this height. Also, vessel heads protected by support skirts with limited ventilation are normally not included when determining wetted area. The user shall specify whether to include the wetted surface area of connected piping in the wetted-area calculation.

The wetted area for spheres includes all area up to the maximum diameter. Table 4 recommends the wetted surface area for spheres be based on “the maximum horizontal diameter or up to the height of 7.6 m (25 ft), whichever is greater.” Hence, as a minimum, the wetted surface area of the entire bottom hemisphere shall be used even when the sphere “equator” exceeds 7.6 m (25 ft) in height. The criterion is supported by previous incidents and tests that have shown that pool fire flames can follow the underside profile of spheres resulting in the entire bottom hemisphere being exposed to a high fire heat load.

Table 4—Effects of Fire on the Wetted Surfaces of a Vessel

Class of Vessel	Portion of Liquid Inventory	Remarks
Liquid-full, such as treaters	All up to the height of 7.6 m (25 ft)	—
Surge drums, knockout drums, process vessels	Normal operating level up to the height of 7.6 m (25 ft)	—
Fractionating columns	Normal level in bottom plus liquid holdup from all trays dumped to the normal level in the column bottom; total wetted surface up to the height of 7.6 m (25 ft)	Level in reboiler is to be included if the reboiler is an integral part of the column
Working storage	Maximum inventory level up to the height of 7.6 m (25 ft) (portions of the wetted area in contact with foundations or the ground are normally excluded)	For low-pressure [i.e. <103 kPa (15 psig)] storage tanks and process tanks (see API 2000 [11])
Spheres and spheroids	Up to the maximum horizontal diameter or up to the height of 7.6 m (25 ft), whichever is greater	—

4.4.13.2.3 Effect of Fire on the Unwetted Surface of a Vessel

Unwetted wall vessels are those that have no liquid in contact with the internal vessel walls (e.g. internal walls are exposed only to a gas, vapor, or supercritical fluid or they are internally insulated regardless of the contained fluids). These include vessels that contain separate liquid and vapor phases under normal conditions but become single phase (above the critical) at relieving conditions.

Vessels can be designed to have internal insulation (e.g. refractory) and such areas may be considered unwetted. If, however, a vessel can become insulated by the deposition of coke or other materials, the vessel wall shall still be considered wetted for fire-relief sizing (without credit for any insulating effects) but additional protection should be considered (see 4.4.13.2.6 and 4.4.13.2.7).

A characteristic of a vessel with an unwetted internal wall is that heat flow from the wall to the contained fluid is low as a result of the heat transfer resistance of the contained fluid or any internal insulating material. Heat input from a fire to the bare outside surface of an unwetted or internally insulated vessel can, in time, be sufficient to heat the vessel wall to a temperature high enough to rupture the vessel. Figure 1 and Figure 2 indicate how quickly an unwetted bare vessel wall can be heated to rupture conditions. Figure 1 illustrates the rise in temperature that occurs with time in the unwetted plates of various thicknesses exposed to open fire. For example, an unwetted steel plate 25 mm (1 in.) thick takes about 12 min to reach 593 °C (1100 °F) and 17 min to reach 704 °C (1300 °F) when the plate is exposed to a typical open fire. Recent calculations indicate that the absorbed heat flux from the fire is in the range of approximately 80 kW/m² (25,200 Btu/h·ft²) for the observed curve to 100 kW/m² (31,500 Btu/h·ft²) for the calculated curves.

Figure 2 shows the effect of overheating ASTM A515 Grade 70 carbon steel, from data published in Reference [164]. The figure indicates that at a stress of 138 MPa (20,000 psi), an unwetted steel vessel ruptures in about 0.1 h at 649 °C (1200 °F). A source for time-dependent rupture stress for different metals is ASTM Data Series DS 11S1 [27], which contains stress rupture and other elevated temperature property data for wrought carbon steel.

This work was performed by the Materials Properties Council but is available through ASTM. Another source is *Guidelines for the Protection of Pressurised Systems Exposed to Fire* ^[148].

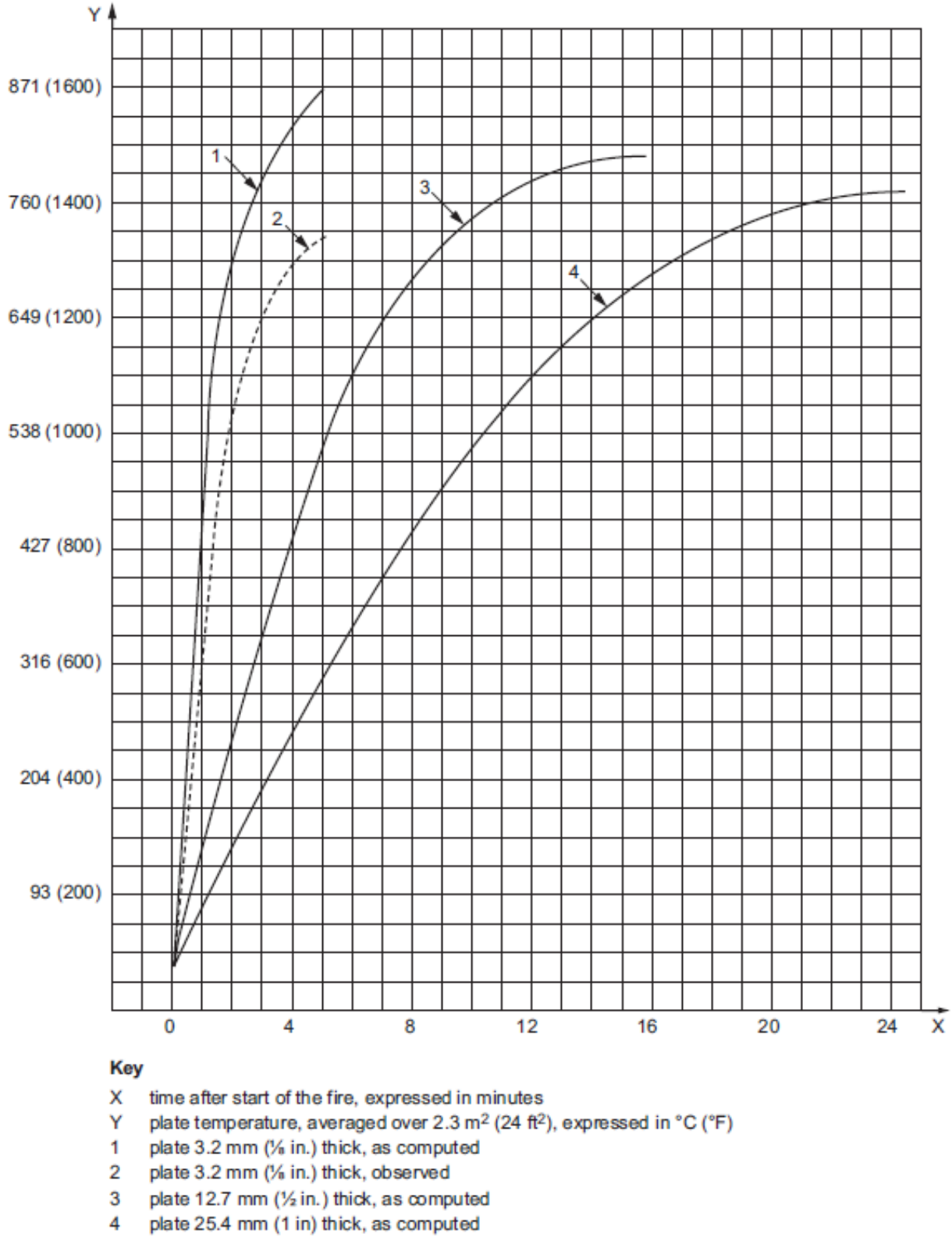

Figure 1—Average Rate of Heating Steel Plates Exposed to Open Gasoline Fire on One Side

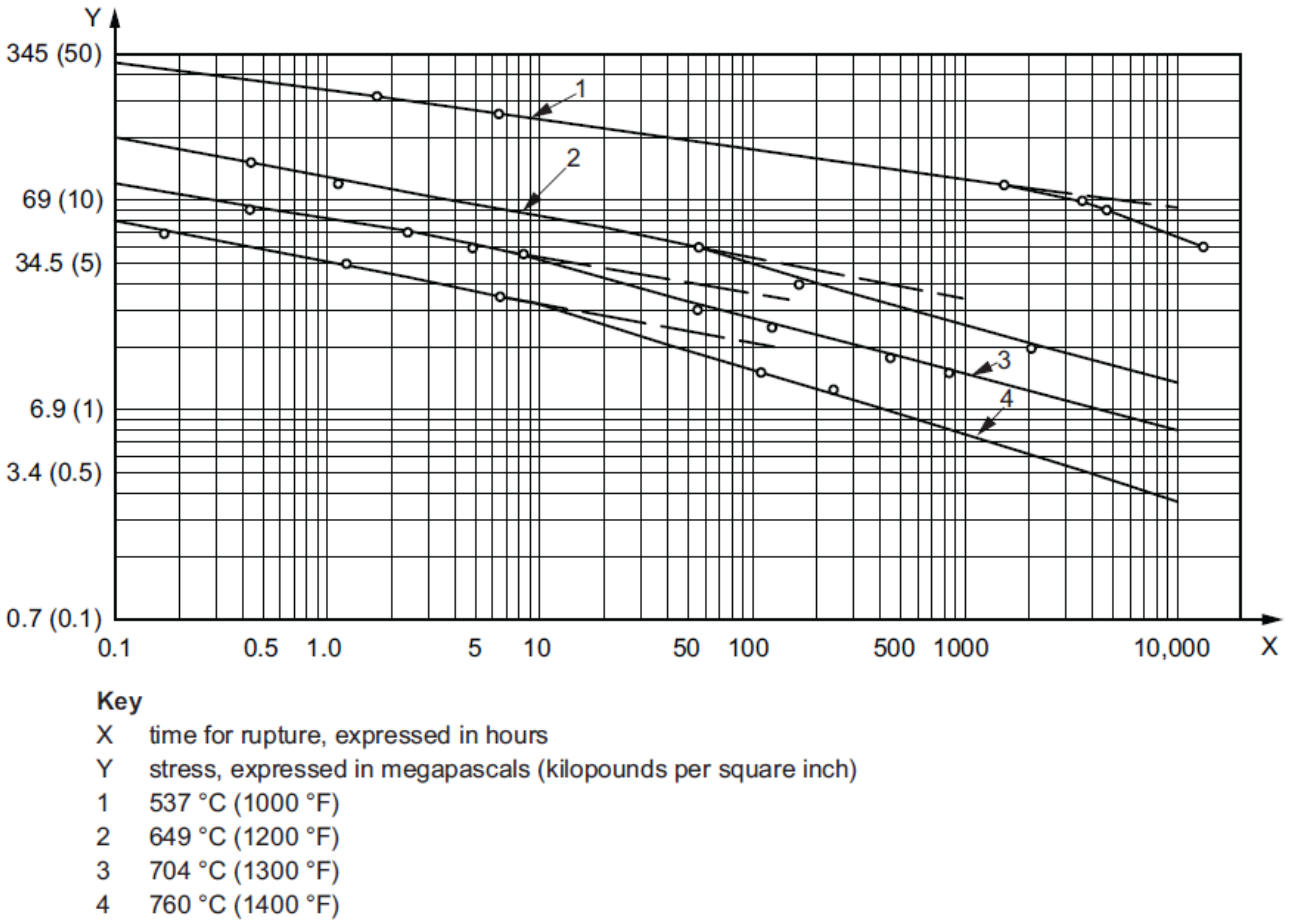

Figure 2—Effect of Overheating Carbon Steel (ASTM A515, Grade 70)

4.4.13.2.4 Fire-relief Loads

4.4.13.2.4.1 General

It is typically assumed that the vessel is isolated during a fire in order to simplify the analysis, although a more detailed analysis can be warranted in certain cases. Crediting for flow paths that remain open during an overpressure event is generally an acceptable practice. However, it should be recognized that operators and/or emergency responders may attempt to isolate certain lines and vessels during a fire condition in order to limit the fire spread and to safely shutdown the unit. There can also be actuated valves that fail in the closed condition when exposed to a fire. It can be difficult to establish with a degree of certainty whether a particular line will indeed remain open under all fire conditions. Further, consideration should be given to the potential that the fire-relief flow in the flow path will overpressure other equipment. Hence, it can be necessary to add the fire-relief load elsewhere. Ultimately, the user shall decide whether a scenario is credible or not.

4.4.13.2.4.2 provides the heat absorption equations for vessels containing liquids, and 4.4.13.2.4.3 provides the equations to determine open-pool-fire-relief requirements for vessels containing only gases/vapors.

Either the vapor thermal-expansion-relief load or the boiling-liquid vaporization-relief load, but not both, should be used. It is a practice that has been used for many years. There are no known experimental studies where separate contributions of vapor thermal expansion versus boiling-liquid vaporization have been determined. When sizing the PRD for fire exposure, the contribution of vaporizing liquid compared with vapor expansion is generally governing unless, for example, the wetted surface has external insulation in accordance with 4.4.13.2.7 and the unwetted surfaces are not insulated.

4.4.13.2.4.2 Heat Absorption Equations for Vessels Containing Liquids

The amount of heat absorbed by a vessel exposed to an open fire is markedly affected by the type of fuel feeding the fire, the degree to which the vessel is enveloped by the flames (a function of vessel size and shape), the environment factor, firefighting, and drainage. Equation (7) is used to evaluate these conditions if there are prompt firefighting efforts and drainage of flammable materials away from the vessels:

$$Q = C_1 \times F \times A_{ws}^{0.82} \quad (7)$$

where

Q is the total heat absorption (input) to the wetted surface, expressed in W (Btu/h);

C_1 is a constant [= 43,200 in SI units (21,000 in USC units)];

F is an environment factor (see Table 5);

A_{ws} is the total wetted surface, expressed in m² (ft²).

NOTE 1 See 4.4.13.2.2 and Table 4.

NOTE 2 The expression, $A_{ws}^{0.82}$, is the area exposure factor or ratio. This ratio recognizes that large vessels are less likely than small ones to be completely exposed to the flame of an open fire.

Table 5—Environment Factor

Type of Equipment		Environment Factor F
Bare vessel		1.0 ^e
Insulated vessel ^{a,b} with insulation conductance values (i.e. insulation thermal conductivity divided by thickness) for fire exposure conditions in W/m ² ·K (Btu/h·ft ² ·°F)	22.71 (4)	0.3
	11.36 (2)	0.15
	5.68 (1)	0.075
	3.80 (0.67)	0.05
	2.84 (0.5)	0.0376
	2.27 (0.4)	0.03
	1.87 (0.33)	0.026
Water application facilities, on bare vessel ^c		1.0 ^e
Depressurizing and emptying facilities ^d		1.0 ^e
Earth-covered storage		0.03
Below-grade storage		0.00

^a These suggested values for the conditions assumed in 4.4.13.2.4. If these conditions do not exist, engineering judgment should be exercised either in selecting a higher factor or in providing means of protecting vessels from fire exposure as suggested in 4.4.13.2.6 and 4.4.13.2.7.

^b Insulation should resist being dislodged by fire hose streams (see 4.4.13.2.7.2). For the examples, a temperature difference of 871 °C (1600 °F) was used. These conductance values are computed from Equation (17) or Equation (18) and are based on insulation having thermal conductivity of 0.58 W/m·K (4 Btu·in./h·ft²·°F) at 538 °C (1000 °F) and correspond to various thicknesses of insulation between 25.4 mm (1 in.) and 304.8 mm (12 in.). See Equation (17) or Equation (18) to determine the environment factor, F .

^c See 4.4.13.2.6.2.

^d See 4.6 and Annex A.

^e The environment factor, F , in Equation (7) and Equation (8) does not apply to uninsulated vessels. The environment factor should be replaced by 1.0 when calculating heat input to uninsulated vessels.

Where adequate drainage and firefighting equipment do not exist, Equation (8) should be used [80]:

$$Q = C_2 \times F \times A_{ws}^{0.82} \quad (8)$$

where

C_2 is a constant [= 70,900 in SI units (34,500 in USC units)].

The selection of the appropriate fire heat-flux equation requires determination if there is “adequate drainage.” The determination of what constitutes adequate drainage is subjective and left to the user to decide but it should be designed to carry flammable/combustible liquids away from a vessel. The method of removal (e.g. sewers, open trenches, sloping, etc.) should consider not only the flow of the flammable or combustible liquids causing the pool fire but also the firewater that is applied by emergency responders. Some example drainage criteria are given in API 2510 [15].

Some measures are necessary to control the spread of major spills from one area to another and to control surface drainage and refinery waste water. This can be accomplished by the strategic use of sewers and trenches with adequate capacity and/or by using the natural slope of the land.

4.4.13.2.4.3 Heat Absorption Equations for Vessels Containing Only Gases, Vapors, or Supercritical Fluids

See 4.4.13.2.3 for a discussion of the effect of fire on the unwetted surface of a vessel.

The discharge areas for PRDs on vessels containing supercritical fluids, gases or vapors exposed to open fires can be estimated using Equation (9). In certain cases, the normal operating pressure can be below the thermodynamic critical conditions but the relieving pressure is supercritical. In such cases, the guidance below can be used to size the relief device. In the use of Equation (9), no credit has been taken for insulation:

$$A = \frac{F' \times A'}{\sqrt{p_1}} \quad (9)$$

where

A is the effective discharge area of the valve, expressed in mm² (in.²);

A' is the exposed surface area of the vessel, expressed in m² (ft²);

p_1 is the upstream relieving absolute pressure, expressed in kPa (psi);

NOTE p_1 is the set pressure plus the allowable overpressure plus the atmospheric pressure.

F' can be determined using Equation (10). If calculated using Equation (10) and the result is less than 182 in SI units (<0.01 in USC units), then use a recommended minimum value of $F' = 182$ in SI units ($F' = 0.01$ in USC units). If insufficient information is available to use Equation (10), then use $F' = 821$ in SI units ($F' = 0.045$ in USC units).

$$F' = \frac{C_9}{C \times K_D} \left[\frac{(T_w - T_1)^{1.25}}{T_1^{0.6506}} \right] \quad (10)$$

where

C_9 is a constant [= 0.2772 in SI units (0.1406 in USC units)];

K_D is the coefficient of discharge (obtainable from the valve manufacturer);

NOTE A K_D value of 0.975 is typically used for preliminary sizing of PRVs (see API 520, Part 1).

T_w is the maximum wall temperature of vessel material, expressed in K (°R);

T_1 is the gas absolute temperature, at the upstream relieving pressure, determined from Equation (12), expressed in K (°R).

The coefficient, C , is given by Equation (11):

$$C = C_{10} \sqrt{k \left(\frac{2}{k+1} \right)^{\frac{k+1}{k-1}}} \quad (11)$$

where

C_{10} is a constant [= 0.0395 (kg-mole-K)^{0.5}/(mm²-kPa-h) in SI units [520 (lb-mole-°R)^{0.5}/(lbf-h) in USC units];

k is the ideal gas specific heat ratio (C_p/C_v) of gas or vapor at relieving temperature.

$$T_1 = \frac{p_1}{p_n} \times T_n \quad (12)$$

where

p_n is the normal operating gas absolute pressure, expressed in kPa (psia);

T_n is the normal operating gas absolute temperature, expressed in K (°R).

The recommended maximum vessel wall temperature, T_w , for the usual carbon steel plate materials is 593 °C (1100 °F). If vessels are fabricated from alloy materials, the value for T_w should be based on the stress rupture data for that material. See 4.4.13.2.3, 4.4.13.2.6, 4.6.1, and Annex A for guidance on the potential for vessel failure from overtemperature due to fire exposure.

If $F' \geq 182$ in SI units ($F' \geq 0.01$ in USC units), the relief load, $q_{m,\text{relief}}$, expressed in kg/h (lb/h), can be calculated directly by rearranging the critical vapor equation and substituting Equation (9) and Equation (10), which results in Equation (13):

$$q_{m,\text{relief}} = C_{12} \sqrt{M \times p_1} \left[\frac{A'(T_w - T_1)^{1.25}}{T_1^{1.1506}} \right] \quad (13)$$

where

M is the relative molecular mass of the gas;

C_{12} is a constant [= 0.2772 in SI units (0.1406 in USC units)].

The minimum relief load recommended for sizing where $F' < 182$ in SI units ($F' < 0.01$ in USC units) is calculated by setting $F' = 182$ in SI units ($F' = 0.01$ in USC units), which results in Equation (14):

$$q_{m,\text{relief}} = C_{13} CA' \sqrt{\frac{Mp_1}{T_1}} \quad (14)$$

where

C_{13} is a constant [= 182 in SI units (0.01 in USC units)].

NOTE To derive Equation (13) and Equation (14), Z , K_b , and K_c in API 520, Part 1, Equation (3) have each been assumed to have a value of 1. For Equation (14), K_D is conservatively assumed to have a value of 1.

The derivations of Equations (9), (10), (13), and (14)^[53] are based on the physical properties of air and the perfect gas laws. The derivations assume that the vessel is uninsulated and has no mass, that the vessel wall temperature does not reach rupture stress temperature, and that there is no change in fluid temperature. These assumptions should be reviewed to ensure that they are appropriate for any particular situation. Insulation that meets the external insulation criteria outlined in 4.4.13.2.7 offers a mitigating benefit when gas-filled vessels are exposed to a fire by decreasing the rate at which the metal wall temperature rises.

The surface area potentially exposed to a fire should be used when determining the fire-relief requirements of gas-filled vessels.

4.4.13.2.4.4 Alternative Methods

If the user considers that the preceding assumptions in 4.4.13.2.4 are not appropriate, more rigorous methods of calculations may be specified (e.g. Annex A). In such cases, it can be necessary to obtain the required physical properties of the containing fluid from actual data or estimated from equations of state. It might be necessary to consider the effects of vessel mass and insulation. The pressure-relieving rate is derived from an unsteady-state analysis. One approach that is applicable for fluids without a phase change (e.g. gases, nonflashing liquids, or supercritical fluids) is described below.

Starting at the initial operating pressure and operating temperature, assume the pressure increases via a constant-volume process until the relieving pressure is reached. This will be the starting condition for determining the relief rate and relief area. The fire heat input [kW (Btu/h)] can be calculated using the analytical method given in Annex A. Select a time increment (usually 5 s to 10 s) and multiply the fire heat input by the time increment. Then, perform constant-pressure expansion using the following equations with the starting condition and the heat input over the time increment.

The expansion of volume and incremental mass to be relieved can be calculated from the Equation (15) and Equation (16):

$$[V_{n+1} - V_n] = \frac{Q \times \left(\frac{1}{\rho_{n+1}} - \frac{1}{\rho_n} \right)}{(H_{n+1} - H_n)} \quad (15)$$

$$[M_n - M_{n+1}] = V_0 (\rho_n - \rho_{n+1}) \quad (16)$$

where

V_{n+1} is the volume calculated at Step ($n + 1$), expressed in m^3 (ft^3);

V_n is the volume calculated at Step (n) after the incremental volume has been relieved, and is equal to the initial volume V_0 , expressed in m^3 (ft^3) (see NOTE 2);

Q is the heat input into the system for the time increment represented by the step from (n) to ($n + 1$), expressed in kJ (Btu);

ρ_{n+1} is the density calculated at Step ($n + 1$), expressed in kg/m^3 (lb/ft^3);

ρ_n is the density calculated at Step (n), expressed in kg/m^3 (lb/ft^3);

H_{n+1} is the enthalpy calculated at Step ($n + 1$), expressed in kJ/kg (Btu/lb);

H_n is the enthalpy calculated at Step (n), expressed in kJ/kg (Btu/lb);

V_0 is the initial volume of the system, expressed in m^3 (ft^3) (see NOTE 2);

M_{n+1} is the mass calculated at Step ($n + 1$), expressed in kg (lb);

M_n is the mass calculated at Step (n), expressed in kg (lb).

NOTE 1 Many commercial simulation packages will require the entry of data in terms of a rate (i.e. volume flow rate, mass flow rate, and heat flow rate) instead of a specific quantity. The procedure can be modified for use with these packages by substituting a flow rate for the specific quantity, as long as the units of measurement selected for time are consistent.

NOTE 2 As this procedure is intended to model a constant volume process, each step in the iteration ends with the removal of the incremental volume (as it is vented through the relief device); therefore, the term V_n remains constant and is equal to the initial volume V_0 .

NOTE 3 A time limit of about 2 h is often considered because it is consistent with the fire insulation criteria.

NOTE 4 Ensure the physical property correlation used is valid through the transition into the thermodynamic critical region.

NOTE 5 Large time increments may obscure the peak rate resulting in underestimation of the PRD size.

In these cases, the volume change ($V_{n+1} - V_n$) is the volume that needs to be relieved. The above is repeated until a time limit is reached (see NOTE 3 above) or until a peak volumetric rate is reached (i.e. the step preceding where the volumetric rate starts to decrease). This rate is then used to size the PRD. Because the fluid may not be an ideal gas or the fluid can cross into the two-phase regime as it depressures, the numerical integration method as described in API 520, Part 1, Annex B is recommended to determine the required PRD area.

As the fire continues, the vessel wall temperature and the contained-gas temperature and pressure increase with time. The PRD opens at the set pressure. With the loss of fluid on relief, the temperatures further increase at the relief pressure. If the fire is of sufficient duration, the temperature increases until vessel rupture occurs. Procedures are available for estimating the changes in average vessel wall and contained-fluid temperatures that occur with time and the maximum relieving rate at the set pressure ^{[72] [79]}. These procedures require successive iteration. For fire-insulated segments exposed to fire, it is recommended to assume the fire temperature at the outer boundary of the insulation layer and that the heat input to the fluid is calculated by conduction through the insulation layer and the vessel wall. The heat transfer resistance from the wall to the fluid is very low compared to the insulation layer's resistance and can be (is usually) neglected. A more rigorous method is described in Reference [134].

There are temperature differences between the liquid and gas phases. Tools are becoming available to perform nonequilibrium temperature calculations; for further information, see Reference [148].

4.4.13.2.5 Fluids to Be Relieved

4.4.13.2.5.1 General

A vessel can contain liquids or vapors or fluids of both phases. The liquid phase can be subcritical at operating temperature and pressure and can pass into the critical or supercritical range during the duration of a fire as the temperature and pressure in the vessel increase.

The quantity and composition of the fluid to be relieved during a fire depend on the total heat input rate to the vessel under this contingency and on the duration of the fire.

The total heat input rate to the vessel may be computed by means of one of the equations in 4.4.13.2.4 using the appropriate values for wetted or exposed surfaces and for the environment factor.

Once the total heat input rate to the vessel is known, the quantity and composition of the fluid to be relieved can be calculated, providing that enough information is available on the composition of the fluid contained in the vessel.

If the fluid contained in the vessel is not completely specified, assumptions should be made to obtain a realistic relief flow rate for the relief device. These assumptions may include the following:

- a) estimation of the latent heat of the boiling liquid and the appropriate relative molecular mass of the fraction vaporized;
- b) estimation of the thermal expansion coefficient if the relieving fluid is a liquid, a gas, or a supercritical fluid where a phase change does not occur.

4.4.13.2.5.2 Vapor

For pressure and temperature conditions below the critical point, the rate of vapor formation (a measure of the rate of vapor relief required) is equal to the total rate of heat absorption divided by the latent heat of vaporization. The vapor to be relieved is the vapor that is in equilibrium with the liquid under conditions that exist when the PRD is relieving at its accumulated pressure.

The latent heat and relative molecular mass values used in calculating the rate of vaporization should pertain to the conditions that are capable of generating the maximum vapor rate.

The vapor and liquid composition can change as vapors are released from the system. As a result, temperature and latent-heat values can change, affecting the required size of the PRD. On occasion, a multicomponent liquid can be heated at a pressure and temperature that exceed the critical temperature or pressure for one or more of the individual components. For example, vapors that are physically or chemically bound in solution can be liberated from the liquid upon heating. This is not a standard latent-heating effect but is more properly termed degassing or dissolution. Vapor generation is determined by the rate of change in equilibrium caused by increasing temperature.

For these and other multicomponent mixtures that have a wide boiling range, it might be necessary to develop a time-dependent model where the total heat input to the vessel not only causes vaporization but also raises the temperature of the remaining liquid, keeping it at its boiling point.

The recommended practice of finding a relief vapor flow rate from the heat input to the vessel and from the latent heat of liquid contained in the vessel becomes invalid near the critical point of the fluid, where the latent heat approaches zero and the sensible heat dominates. If no accurate latent heat value is available for these hydrocarbons near the critical point, a minimum value of 115 kJ/kg (50 Btu/lb) is sometimes acceptable as an approximation. If pressure-relieving conditions are above the critical point, the rate of vapor discharge typically depends on the rate at which the fluid expands as a result of the heat input because a phase change does not occur.

Reference [72] gives an example of a time-dependent model used to calculate relief requirements for a vessel that is exposed to fire and that contains fluids near or above the critical range.

4.4.13.2.5.3 Liquid

The hydraulic expansion equations given in 4.4.12.3 may be used to calculate the initial liquid-relieving rate in a liquid-filled system when the liquid is still below its boiling point. However, this rate is valid for a very limited time, after which vapor generation becomes the determining contributor in the sizing of the PRD.

There is an interim time period between the liquid expansion and the boiling-vapor relief during which it is necessary to relieve the mixtures of both phases simultaneously, either as flashing, bubble, slug, froth or mist flow until sufficient vapor space is available inside the vessel for vapor-liquid disengagement. With the exception of foamy fluids, reactive systems and narrow-flow passages (such as vessel jackets), this mixed-phase condition is usually neglected during sizing and selecting of the PRD. The aforementioned exceptions are discussed further in 4.4.13.2.5.4. Experience as well as recent work in this area^[68, 70, 122, 156] has shown that the time required to heat a typical system from the PRD set pressure to the relieving conditions allows for the relief of any two-phase flow prior to reaching the relieving conditions. As such, full disengagement of the vapor is realized at the relieving conditions and the assumption of vapor-only venting is appropriate for relief device sizing.

Experience has shown that there is minimal impact on the discharge system for the two-phase transition period. However, the user may consider the impact of transient two-phase flow on the design of the discharge systems.

If a PRD is located below the liquid level of a vessel exposed to fire conditions, the PRD should be able to pass a volume of fluid equivalent to the volume of vapor generated by the fire.

Determination of the appropriate state of the fluid can be complicated. A typical conservative assumption is to use bubble point liquid.

4.4.13.2.5.4 Mixed Phase

Two-phase PRD sizing is not normally required for the fire case, except for unusually foamy materials or reactive chemicals [66, 68, 70, 122, 157].

In nonreactive systems subjected to an external fire, boiling occurs at or near the walls of the vessel, commonly referred to as wall-heating. On the other hand, reactive systems in which an external fire can result in an exothermic reaction are subject to boiling throughout the volume of the vessel due to heat evolved from the reaction. This is commonly referred to as volumetric heating, which results in more liquid-swell than wall-heating and, thus, increases the potential for longer-duration two-phase relief. Furthermore, significantly higher heat-generation rates associated with runaway reactions result in higher vapor velocities and further potential for long-duration two-phase flow. DIERS concluded an intensive research program to develop methods for the design of emergency relief systems to handle runaway reactions. The interested reader can obtain more information on this subject from References [66] and [69].

4.4.13.2.6 Protective Measures Excluding Insulation

4.4.13.2.6.1 General

A PRD may not provide sufficient protection from vessel rupture due to open pool fire exposure for an unwetted-wall vessel or a vessel containing high boiling point liquid. Where a PRV alone is not adequate, additional protective measures should be considered, such as water sprays (see 4.4.13.2.6.2), depressuring (see 4.6 and Annex A), earth-covered storage (see 4.4.13.2.6.3), and diversion walls (see 4.4.13.2.6.4).

Where local jurisdiction permits, it can be appropriate to utilize these protective measures as an alternative to relief devices sized for the fire case under the following circumstances:

- a) vessel contains vapor only or a high boiling point liquid;
- b) an engineering analysis indicates that additional protection provided by the relief device serves little value in reducing the likelihood of vessel rupture.

The design should allow sufficient time for operator reaction and initiation of firefighting procedures to avoid vessel rupture. Operator action may include depressuring, using water sprays, employing firewater monitors, and isolating the source of fuel. Where there is insufficient time for operator reaction, then automated actuation of depressuring, water spray, or isolation should be considered.

4.4.13.2.6.2 Cooling the Surface of a Vessel with Water

The effect of water is twofold:

- a) cooling of surface, and
- b) reduction of fire heat flux.

Under ideal conditions, water films covering the metal surface can absorb most incident radiation from pool fire flame impingement. The reliability of water application depends on many factors. Freezing weather, high winds, clogged systems, unreliable water supply, and vessel surface conditions can prevent uniform water coverage. Because of these uncertainties, no reduction in environment factor (see Table 5) is recommended; however, as stated previously, properly applied water can be very effective. NFPA 15^[124] and API 2030^[13] provide design guidance for fixed water spray systems.

4.4.13.2.6.3 Earth-covered Storage

Covering a pressure vessel with earth is another effective method of limiting heat input.

4.4.13.2.6.4 Limiting Fire Areas with Drainage or Diversion Walls

Removal of hydrocarbons from an area through proper drainage can minimize the extent of impact of a pool fire. Diversion walls can be provided to deflect vessel spills from other vessels.

4.4.13.2.7 External Insulation

4.4.13.2.7.1 General

Credit for thermal insulation is typically not taken because it usually does not meet the fire-protection insulation requirements given in 4.4.13.2.7.2 through 4.4.13.2.7.4. If these requirements are met, a reduction in fire heat input can be obtained by using the environment factor, F (see Table 5), and Equation (17) or Equation (18) or by calculating the actual heat flow through insulation taking the conductivity and thickness into consideration. Where credit is taken for the reduction of heat input as a result of fire protection insulation, this should be documented in the relief system design basis information (see 4.7).

4.4.13.2.7.2 Installation Considerations for External Insulation Systems

The designer should be certain that any system of insulating materials permits the basic insulating material to function effectively at temperatures up to approximately 904 °C (1660 °F) during a fire. This period of exposure can be for up to 2 h, depending on the adequacy of firefighting provisions, the accessibility of equipment, and the degree of skill and training of the firefighting group. This consideration is especially pertinent to newer installations using foamed or cellular plastic materials that have excellent properties at operating conditions but that (unless they were specially treated and pretested) have melted, vaporized, or otherwise been destroyed at temperatures as low as 260 °C (500 °F). Corrosion under insulation (CUI) should be considered when installing insulation.

The finished installation should ensure that fire protection insulation is not dislodged when it is subjected to the high-pressure water streams used for firefighting, such as streams from hand lines or monitor nozzles, if installed. Some criteria that should be considered include the ability of the protected system to withstand direct-flame impingement. Fire insulation, or insulation that is part of a composite system, should be capable of withstanding an exposure temperature of approximately 904 °C (1660 °F) for up to 2 h. Insulation system materials selection should consider equipment metallurgy while providing required jacket integrity at fire water pressures and fire temperatures. Stainless steel jacketing and banding have demonstrated satisfactory performance in fire situations. On the other hand, jacketing systems that use aluminum exclusively have not demonstrated satisfactory performance. Insulation materials that may decompose during fires should be avoided or suitably protected with layered composite systems. If the jacket and/or banding integrity is compromised, insulation credit can still be taken in accordance with Equation (17) or Equation (18) if it can be demonstrated that the insulation material integrity and temperature resistance are maintained per requirements above [i.e. not dislodged by high-pressure water stream and withstand an exposure temperature of approximately 904 °C (1660 °F) for 2 h].

4.4.13.2.7.3 Physical Properties of Insulation Systems

The value of thermal conductivity used in calculating the environmental factor credit for insulation should be the thermal conductivity of the insulation at the mean temperature between approximately 904 °C (1660 °F) and the process temperature expected at relieving conditions (see 4.4.13.2.7.4). If reasonably possible, the variation in conductivity due to service and maintenance practices from known laboratory values should be taken into account. Therefore, the user should consult with the insulation material supplier as to the actual temperature limits for the insulation material. Where multiple-layer insulating systems consist of different materials, the physical characteristics of each material under the expected temperature conditions should be examined. Typical values of thermal conductivity for various insulating materials appear in Table 6. It is important to note that there may be several grades of each type of insulation shown in Table 6. The thermal conductivity and maximum temperature values shown in Table 6 can vary depending upon grade and should be verified for the specific grade of insulation being used.

Table 6—Thermal Conductivity Values for Typical Thermal Insulations

Average Temperature of Insulation °C (°F)	Thermal Conductivity for Selected Material W/m·K (Btu·in./h·ft ² ·°F)						
	Calcium Silicate Type I ^[21]	Calcium Silicate Type II ^[21]	Mineral Fiber Mesh Blanket/Block ^a _[23, 24, 26]	Cellular Glass Type I Gr 2 ^[22]	Molded Expanded Perlite Block ^[25]	Lightweight Cementitious ^{b [77]}	Dense Cementitious ^{b [77]}
−18 (0)	—	—	—	0.045 (0.31)	—	0.519 (3.6)	1.760 (12.2)
38 (100)	—	—	0.039 (0.27)	0.053 (0.37)	—	0.519 (3.6)	1.731 (12.0)
93 (200)	0.065 (0.45)	0.078 (0.54)	0.049 (0.34)	0.063 (0.44)	0.079 (0.55)	0.519 (3.6)	1.702 (11.8)
149 (300)	0.072 (0.50)	0.084 (0.58)	0.063 (0.44)	0.075 (0.52)	0.087 (0.60)	0.519 (3.6)	1.673 (11.6)
204 (400)	0.079 (0.55)	0.088 (0.61)	0.079 (0.55)	0.091 (0.63)	0.095 (0.66)	0.519 (3.6)	1.659 (11.5)
260 (500)	0.087 (0.60)	0.092 (0.64)	0.101 (0.70)	—	0.107 (0.74)	0.519 (3.6)	1.630 (11.3)
315 (600)	0.095 (0.66)	0.097 (0.67)	0.128 (0.89)	—	0.115 (0.80)	0.519 (3.6)	1.615 (11.2)
371 (700)	0.102 (0.71)	0.101 (0.70)	0.163 (1.13)	—	0.127 (0.88)	0.519 (3.6)	1.587 (11.0)
427 (800)	—	0.105 (0.73)	—	—	—	0.519 (3.6)	1.572 (10.9)
482 (900)	—	0.108 (0.75)	—	—	—	0.519 (3.6)	1.543 (10.7)
538 (1000)	—	0.111 (0.77)	—	—	—	0.519 (3.6)	1.514 (10.5)
593 (1100)	—	—	—	—	—	0.519 (3.6)	1.486 (10.3)
649 (1200)	—	—	—	—	—	0.519 (3.6)	1.471 (10.2)
	Maximum temperature for example of insulation listed ^d °C (°F)						
	649 (1200)	927 (1700)	649 (1200)	c	c	Approx. 870 (1600)	Approx. 1090 (2000)
<p>^a “Mineral fiber blanket/block” comprises rock, slag, or glass processed from the molten state into fibrous form. The thermal conductivities shown in the table are the highest values for the various forms of the insulation suitable for the maximum use temperature indicated.</p> <p>^b Thermal conductivities for lightweight and dense cementitious materials are approximate.</p> <p>^c Maximum use temperature not given in ASTM C552 ^[22] and ASTM C610 ^[25].</p> <p>^d There may be other grades of insulation that have higher maximum temperatures.</p>							

4.4.13.2.7.4 Calculation of Environment Factor for External Insulation

Limiting the heat input from fires by external insulation reduces both the rise of the vessel wall temperature and the generation of vapor inside the vessel. Insulation can also reduce the problem of disposing of the vapors and the expense of providing an exceptionally large relieving system to conduct the effluent to a point of disposal.

If an external insulation system is designed to limit fire heat input, it should conform to the insulation considerations of 4.4.13.2.7.2.

If insulation or fireproofing is applied, the heat absorption can be computed by assuming that the outside temperature of the insulation jacket or other outer covering has reached an equilibrium temperature of approximately 904 °C (1660 °F). With this temperature and the operating temperature for the inside of the vessel, together with the thickness and conductivity of the fire-protection coating, the average heat transfer rate to the contents can be computed. It should be kept in mind that the thermal conductivity of the insulation increases with the temperature and that a mean value should be used.

For single-layer insulated vessels, the environment factor, F (see Table 5), for insulation is given by Equation (17) and Equation (18).

In SI units:

$$F = \frac{k(904 - T_f)}{66,570 \delta_{\text{ins}}} \quad (17)$$

In USC units:

$$F = \frac{k(1660 - T_f)}{21,000 \delta_{\text{ins}}} \quad (18)$$

where

k is the thermal conductivity of insulation at mean temperature, expressed in W/m·K (Btu·in/h·ft²·°F);

δ_{ins} is the thickness of insulation, expressed in m (in.);

T_f is the temperature of vessel contents at relieving conditions, expressed in °C (°F).

For multilayered insulated vessels, the environment factor for insulation is given by Equation (19) and Equation (20):

In SI units:

$$F = \frac{(904 - T_f)}{66,570 \sum_{i=1}^n \left(\frac{\delta_{\text{ins},i}}{k_i} \right)} \quad (19)$$

In USC units:

$$F = \frac{(1660 - T_f)}{21,000 \sum_{i=1}^n \left(\frac{\delta_{\text{ins},i}}{k_i} \right)} \quad (20)$$

where

k_i is the thermal conductivity of the i th insulation layer at mean temperature, expressed in $W/m \cdot K$ ($Btu \cdot in./h \cdot ft^2 \cdot ^\circ F$);

$\delta_{ins,i}$ is the thickness of the i th insulation layer, expressed in m (in.);

T_f is the temperature of vessel contents at relieving conditions, expressed in $^\circ C$ ($^\circ F$).

Note that for large values of insulation thermal conductivity and/or for low values of insulation thickness an environment factor greater than 1.0 can be calculated. In this case, an environment factor (F) equal to 1.0 should be used. If pressure-relief facilities are designed taking credit for insulation ($F < 1$) and the insulation is removed at a later time, the PRD sizing should be rechecked using $F = 1.0$ to ensure that the relief device is adequate for the new condition.

4.4.13.2.8 Air-cooled Heat Exchangers

4.4.13.2.8.1 General

Fire exposure of air-cooled coolers and condensers shall be taken into account. Although the material in 4.4.13.2.8.1 through 4.4.13.2.8.4 is offered as a guide, the individual circumstances involved in each situation should be considered.

Air-cooled heat exchangers are unique because unlike shell-and-tube units, their heat transfer surface is exposed directly to the fire. They are designed for ambient inlet air conditions and they rapidly lose all cooling and condensing ability when they are exposed to fire-heated air. Assuming that the heat exchangers are treated as vessels (see 4.4.13.2.4), the relieving load can be calculated using the wetted bare-tube area of the tube bundle exposed to radiation from the fire as a basis for establishing the area term. The bare-tube area is used instead of the finned-tube area because most types of fins are destroyed within the first few minutes of exposure to fire. Heat input due to convective heat transfer may be neglected.

The calculation of the wetted bare-tube area exposed to radiation from the fire depends on the location of the heat exchanger relative to the potential fire and the heat exchanger service. As a general rule, it is necessary to consider only that portion of the bare surface on air-cooled heat exchangers located within the fire area being evaluated in the calculation of fire loads. This would normally exclude all air-cooled heat exchangers located directly above pipe racks, since the area under pipe racks is not normally included within the boundaries of fire-risk areas. Guidelines for specific services are provided in 4.4.13.2.8.2 through 4.4.13.2.8.4.

4.4.13.2.8.2 Gas Cooling Service

It is not necessary to consider the bare area of air-cooled heat exchangers in gas cooling service in the calculation of fire loads, since there is no associated vapor generation and the tubes are likely to fail due to overheating.

4.4.13.2.8.3 Condensing Service

It is not necessary to consider the bare area for air-cooled condensers, whether partial or total condensing, as long as both of the following conditions are satisfied.

- a) The tubes are self-draining.
- b) There is no control valve or pump connected directly to the condenser liquid outlet that would prevent liquids from draining during the fire.

The reason for this is that in the event of a fire, condensation stops and any residual condensate drains freely to the downstream receiver.

If the conditions specified above are not met, the condenser shall be treated as a liquid cooler for the purposes of estimating fire loads (see 4.4.13.2.8.4).

4.4.13.2.8.4 Liquid Cooling Service

For liquid coolers and for condensers not covered by 4.4.13.2.8.3, the wetted area shall be the bare area of the tubes located within the fire risk area and within 7.6 m (25 ft) of grade (or any other surface at which a major fire could be sustained, such as a solid platform). For tubes located higher than 7.6 m (25 ft) above grade (or other surface at which a major fire could be sustained), the wetted area may be taken as zero for forced draft units (the tubes are shielded from radiant heat exposure by the fan hood) and as the projected area (length times width) of the tube bundle for induced draft units. In calculating the heat absorption due to fire exposure, Equation (7) and Equation (8) are applied with an exponent of 1.0 to the wetted area term.

If there are prompt firefighting efforts and drainage of flammable materials away from the air cooler:

$$Q = C_1 \times A_{ws} \quad (21)$$

where

Q is the total heat absorption (input) to the wetted surface, expressed in W (Btu/h);

C_1 is a constant [= 66,300 in SI units (21,000 in USC units)];

A_{ws} is the total wetted surface, expressed in m² (ft²).

Where adequate drainage and firefighting equipment do not exist, the following equation should be used:

$$Q = C_2 \times A_{ws} \quad (22)$$

where

C_2 is a constant [= 108,900 in SI units (34,500 in USC units)].

NOTE The constants C_1 and C_2 are based on a constant heat flux corresponding to that calculated by Equation (7) and Equation (8) for a wetted area of 0.0929 m² (1 ft²).

4.4.13.2.8.5 Fire Mitigation Alternatives

Calculated fire-relief loads can be extremely large and unrealistic for a liquid-filled air cooler exposed to a pool fire. Installation of sufficient relief area based on these calculations would result in the entire contents of the air cooler being vented in a few seconds. After venting, the tubes would no longer be wetted resulting in their prompt failure in the fire. Further, the large relief load can significantly impact the design of the discharge system (i.e. knockout drum and flare).

Air coolers essentially consist of piping with inlet and outlet manifolds. It is the convention not to consider sizing PRDs for piping when considering the fire scenario. Instead of pressure relief, fire protection, equipment isolation, and other means are employed to mitigate the consequences of piping exposed to fire. Similarly, mitigation options can be considered in lieu of a PRD for air coolers when considering the fire scenario. The following are guidelines to mitigate the fire case for air coolers.

- a) The air cooler should not be located above equipment containing or transporting large amounts of flammable liquids. Equipment in this classification includes pumps, heat exchangers, surge drums, reboilers, and accumulators, but rack piping can be normally excluded.
- b) All grading below air coolers should be sloped so that a pool fire does not occur below the air cooler.
- c) The air coolers should be located either at the ends of a process unit or as far distant as possible from other liquid-full equipment.
- d) If the location criteria cited above cannot be met, an automatic water deluge system should be considered to cool the tubes if a fire should occur. Alternatively, a means to isolate the air cooler from large inventories of liquid during a fire should be considered. The use of remotely or automatically activated valves is the preferred isolation method. Manual isolation can also be considered, provided the valves are in a location that is accessible during a fire.
- e) In some cases, the air cooler cannot readily be isolated from major inventories of flammable or combustible liquids (e.g. if the air cooler is located between a tower and reflux drum). In these cases, it is prudent to have the air cooler free-draining toward the drum or column, thereby minimizing the wetted surface area exposed to a fire.

4.4.13.3 Confined Pool Fires

Confined fires are divided into fuel-controlled fires and ventilation-controlled fires. A ventilation-controlled fire is in shortage of air, hence the available air—the ventilation—controls the heat release rate. A fire inside compact process modules or in buildings may result in a ventilation-controlled fire. Confined fires typically have higher heat fluxes than open fires but their size can be limited due to lack of ventilation (i.e. combustion air).

If the confined pool fire is fuel controlled, then the effect of confinement is moderate for small and medium size confined fires because the heat-up of the confinement will be slow (compared to the depressurization time) and limited. In other words, the effect of preheating and reduced reradiation is slow and kept at a moderate level. In these conditions, a fuel-controlled confined pool fire behaves like an open pool fire, so the use of the open pool fire equations (see 4.4.13.2.4) will be appropriate.

If the ratio between fire volume and confined volume becomes large, then the use of the open pool fire equations (see 4.4.13.2.4) could underestimate the heat input to exposed equipment. In these cases, the methodology in Annex A should be used with an increased fire temperature to account for effects of preheating and reradiation.

Partial confinement can also result in higher heat fluxes and enhanced exposure of the wetted surfaces to the pool fire. An example is where a vessel is partially confined by adjacent embankments or walls with a height comparable to the vessel's height. Full-scale tests have been performed with this type of configuration^[29, 32, 112]. The test data indicate that the heat input into the vessel was higher than predicted by Equation (8) on the sides of the vessel adjacent to the embankment. If a PRD is sized for the fire scenario involving vessels with this type of configuration, then a conservative approach would be to apply Equation (23). This approach is supported by the earlier API work described in Reference [80] and more recent fire test data (see C.6.5.1.2 and C.6.5.2).

$$Q = C_2 \times F \times A_{ws} \quad (23)$$

where

Q is the total heat absorption (input) to the wetted surface, expressed in W (Btu/h);

C_2 is a constant [= 108,900 in SI units (34,500 in USC units)];

F is an environment factor (see Table 5);

A_{ws} is the total wetted surface, expressed in m² (ft²).

It is up to the user to determine the type and size of the pool fire used for design of protection systems (e.g. pressure relief, depressuring, fireproofing). Where the main objective with respect to fire protection of process piping and equipment is to prevent a small (and controllable) fire from escalating to a larger (and uncontrollable) fire, then the large confined fires can be disregarded and the confined fires can be modeled as an open fire^[148].

4.4.13.4 Jet Fires

Protection from jet fire exposure is typically addressed through means other than PRDs because failure often occurs due to localized overheating for which a PRD is ineffective.

Jet fire characteristics include unpredictability of the source (leak) and flame impingement locations, unpredictability of the jet flame length, and significantly increased heat loading to the vessel's wetted and unwetted surfaces relative to a pool fire (see Annex A). In addition, potential mitigation measures (e.g. water spray) can be adversely impacted by the effect of the jet fire velocity.

Jet fires can occur when almost any combustible/flammable fluid under pressure is released to atmosphere. The primary concern with jet fire impingement is that the equipment can fail due to intense, localized overheating of the metal wall where the jet fire impinges. Failure can occur even without increasing the pressure in the equipment to the set point of the relief device. This is due to the localized nature of heating whereby the bulk fluid temperature might not increase appreciably. Hence, a relief device (i.e. overpressure protection device) might not prevent vessel failure from jet fire impingement.

Instead of a pressure-relief system, protection against jet fires focuses on prevention of leaks through proper maintenance and/or mitigation systems such as external insulation, depressuring systems, isolation of leaks, equipment and/or flange orientation and minimization and emergency response. Installation of external insulation provides additional time (an impinging jet fire can cause vessel failure in less than 5 min, depending on the vessel's wall thickness and material) but might not prevent failure as the external insulation can be eroded by the momentum effects of the jet fire. Depressuring systems are discussed in 4.6. Finally, unlike a pool fire, a jet fire can, in essence, be "turned off" through isolation and depressurization of the jet fire source (i.e. leaking pipe, vessel, or other equipment).

4.4.14 Heat Transfer Equipment Failure

4.4.14.1 Requirements

Heat exchangers and similar vessels may require protection with a relieving device of sufficient capacity to avoid overpressure in case of an internal failure. This statement defines a broad problem but also presents the following specific problems:

- a) type and extent of internal failure that can be anticipated;
- b) determination of the required relieving rate if overpressure of the low-pressure side of the heat exchanger and/or connected equipment occurs as a result of the postulated failure;
- c) selection of a relieving device that reacts fast enough to prevent the overpressure;
- d) selection of the proper location for the device so that it senses the overpressure in time to react to it.

Provision of overpressure protection for the heat exchanger and associated pipework does not remove the need for a process hazard analysis (PHA) to consider the wider process implications of any interstream leakage.

These guidelines were established without considering a chemical reaction in the event that the high-pressure fluid mixes with the low-pressure fluid. If the heat exchanger contains reactive chemicals, then an evaluation of the potential overpressure shall be performed (see 4.4.11).

4.4.14.2 Shell-and-tube Heat Exchangers

4.4.14.2.1 Pressure Considerations

Complete tube rupture, in which a large quantity of high-pressure fluid flows to the lower-pressure heat exchanger side, is a remote but possible contingency. Minor leakage can seldom overpressure a heat exchanger during operation; however, such leakage occurring where the low-pressure side is closed in can result in overpressure. Loss of containment of the low-pressure side to atmosphere is unlikely to result from a tube rupture where the pressure in the low-pressure side (including upstream and downstream systems) during the tube rupture does not exceed the corrected hydrotest pressure (see 3.1.19 and 4.2.2). The user may choose a pressure other than the corrected hydrotest pressure, given that a proper detailed mechanical analysis is performed showing that a loss of containment is unlikely. The use of maximum possible system pressure instead of design pressure may be considered as the pressure of the high-pressure side on a case-by-case basis where there is a substantial difference in the design and operating pressures for the high-pressure side of the heat exchanger.

Pressure relief for tube rupture is not required where the low-pressure heat exchanger side (including upstream and downstream systems) does not exceed the criteria noted above. The tube rupture scenario can be mitigated by increasing the design pressure of the low-pressure heat exchanger side (including upstream and downstream systems), and/or ensuring that an open flow path can pass the tube rupture flow without exceeding the stipulated pressure, and/or providing pressure relief.

The user may perform a detailed analysis and/or appropriately design the heat exchanger to determine the design basis other than a full-bore tube rupture. However, each heat exchanger type should be evaluated for a small tube leak. The detailed analysis should consider the following:

- a) tube vibration;
- b) tube material;
- c) tube wall thickness;
- d) tube erosion;
- e) brittle fracture potential;
- f) fatigue or creep;
- g) corrosion or degradation of tubes and tubesheets;
- h) tube inspection program;
- i) tube to baffle chafing.

The basis for the analysis should be documented and maintained with the relief system design information (see 4.7).

4.4.14.2.2 Determining the Required Relief Flow Rate

In practice, an internal failure can vary from a pinhole leak to a complete tube rupture. For the purpose of determining the required relieving flow rate for the steady-state approach, the following basis should be used.

- a) The tube failure is a sharp break in one tube.
- b) The tube failure is assumed to occur at the back side of the tubesheet.
- c) The high-pressure fluid is assumed to flow both through the tube stub remaining in the tubesheet and through the other longer section of tube.

A simplifying assumption of two orifices may also be used in place of the above method, since this produces a larger relief flow rate than the above approach of a long open tube and tube stub.

The dynamic approach requires a detailed analysis to determine if a design basis smaller than a full-bore tube rupture is adequate.

In determining the relief rate, allowance should be made for any liquid that flashes to vapor either as a result of the pressure reduction or, in the case of volatile fluids being heated, because of the combined effects of pressure reduction and vaporization, as the fluid is intimately contacted by the hotter material on the low-pressure side.

For liquids that do not flash when they pass through the opening, the discharge rate through the failure should be computed using incompressible-flow equations. For vapor passing through the ruptured tube opening, compressible-flow theories apply. Typical steady-state equations for evaluating the flow rate through an orifice or an open tube end, for gas or nonflashing liquid service, are presented in Crane Technical Paper No. 410^[50] or other fluid flow references.

A two-phase flow method should be used in determining the flow rate through the failure for flashing liquids or two-phase fluids. The flow models developed by DIERS and others can be adapted for this purpose. Additional information concerning these models is available in API 520, Part 1 and References [108] and [110]. In cases where the fluid flashes at the low-pressure side of the heat exchanger, two-phase flow methods based on the homogenous equilibrium model, such as those proposed by DIERS, may be used for the flow through the tube to the break, which is assumed to be at the tubesheet. For the flow across the tubesheet to the break, the thickness of the tubesheet should be considered when determining whether single- or two-phase methods should be used. Guidelines on the minimum horizontal flow path length required for homogeneous two-phase methods to be applicable are presented in the literature on this subject. Three literature resources are available for clarification: Reference [65], specifically the section entitled "Non-equilibrium Flashing Flow"; Reference [81]; and Reference [165]. A conservative approach should be taken where any doubt exists.

Two approaches are available for determining the required size of the relief device:

- a) steady state, and
- b) dynamic analysis.

If a steady-state method is used, the PRD size should be based on the gas and/or liquid flow passing through the rupture. Capacity credit can be taken for the low-pressure side piping per the guidelines of 4.4.14.2.4. A one-dimensional dynamic model can be used where the approach is to simulate the pressure profile and pressure transients developed in the heat exchanger from the time of the rupture. These methods generally include the dynamic model of the tube-rupture relief scenario and the response time of the relief device, the accuracy of which is critical in calculating the accuracy of pressures generated. The opening time for the device used should be verified by the manufacturer and should also be compatible with the requirements of the system. Data on the dynamic model of the tube-rupture relief scenario and the response time of the relief device can be found in References [78] and [105].

This type of analysis is recommended, in addition to the steady-state approach, where there is a wide difference in design pressure between the two heat exchanger sides [e.g. 7000 kPa (~1000 psi) or more], especially where the low-pressure side is liquid-full and the high-pressure side contains a gas or a fluid that flashes across the rupture. Modeling has shown that under these circumstances, transient conditions can produce overpressure above the test pressure, even when protected by a PRD [57, 71, 158]. In these cases, additional protection measures should be considered.

4.4.14.2.3 Relief Devices and Locations

The design of piping around the heat exchanger and the location of the relieving device are both critical factors in protecting the heat exchanger. Both rupture disks and PRVs should be considered.

It may be necessary to locate the relieving device either directly on the heat exchanger or immediately adjacent on the connected piping. This is especially important if the low-pressure side of the heat exchanger is liquid-full. In this case, the time interval in which the shock wave is transmitted to the relieving device from the point of the tube failure increases if the device is located remotely. In addition, there is a time delay for the gas to overcome the momentum of the liquid-filled low-pressure side prior to establishing a full flow through the relief path. This can result in higher transient overpressure on the heat exchangers before operation of the rupture disk or relief valve.

It can be impractical to protect some heat exchangers (and associated piping) by relief devices alone (e.g. if there is a high-pressure difference between the shell and tube sides). In these cases, different layers of protection, such as improved metallurgy, more frequent inspection, and increasing the design pressure of the low-pressure side (including upstream and downstream piping until the pressure is dissipated), can be necessary.

4.4.14.2.4 Influence of Piping and Process Conditions

To determine the influence of piping, either in eliminating the need for a relieving device or in reducing relieving requirements, the configuration of the discharge piping and the contents (liquid or vapor) of the low-pressure side should be considered. If the low-pressure side is in the vapor phase, full credit can be taken for the vapor-handling capacity of the outlet and inlet lines, provided that the inlet lines do not contain check valves or other equipment that could prevent backflow. If the low-pressure side is liquid-full, the effective relieving capacity for which the piping system may be credited shall be based on the volumetric flow rate of the low-pressure side liquid that existed prior to the tube rupture. However, if a detailed analysis is performed, a capacity credit may be taken for acceleration of the low-pressure side liquid. The effect of bends present in the low-pressure piping should be taken into account in the mechanical design of the system. For example, short radius bends can excessively increase pipe stresses when the low-pressure side is liquid-full in a tube rupture scenario, as the low-pressure piping can be subject to slug flow. See 5.5.11 for further guidance on mechanical design considerations for the low-pressure side piping.

If the piping system to the low-pressure side of heat transfer equipment contains valves, their effect on the capacity of the system when overpressure occurs should be taken into account. Valves provided only for isolation may be assumed to be fully opened. In calculating relieving-capacity credit for the piping system, one should consider the valves used for control purposes to be in a position equivalent to the minimum normal flow requirements of the specific process. However, this assumption cannot be made if the valve could automatically close because of the emergency situation.

4.4.14.3 Double-pipe Heat Exchangers

The two types of double-pipe heat exchangers are those that actually use schedule pipe as the inner tube and those that use gauge tubes, usually in the heavier gauges. Units that use schedule pipe for the inner conduit or tube are no more likely to rupture the inner pipe than any other pipe in the system. Therefore, it is not necessary to consider a complete tube rupture as requiring a provision for pressure relief. Although complete tube rupture can be unlikely, weld failures can occur, especially if the two pipes are made from dissimilar metals. If the fluids or flow are such that the inner pipe wall is susceptible to significant thinning through corrosion or erosion, then internal pipe failure should be considered. Thinning is likely to be a localized phenomenon. Where no specific experience is available, one method would be to consider a nominal hole size [e.g. 6.4 mm (0.25 in.) in diameter]. The designer is cautioned to evaluate each case carefully and to use sound engineering judgment to decide whether the particular case under study represents an exception. For example, where gauge tubes are used, the designer should determine whether or not they are equivalent to schedule pipe.

4.4.14.4 Plate-and-frame, Spiral-plate, and Welded-block Heat Exchangers

For the purpose of overpressure protection, plate-and-frame, spiral-plate, and welded-block heat exchangers are similar enough in construction that each features the same type of leakage failure modes from the high-pressure side to the low-pressure side. In all three types, the most common cause for leaking from side-to-side is to have an opening (e.g. hole or crack) in a plate although internal plate failures have occurred. Failure mechanisms typically are related to some form of corrosion such as pitting, cracking, or general corrosion.

Note that the plates in these heat exchangers are better supported than tubes in tubular heat exchangers, so vibration damage is not likely. In the case of gasket leaks, plate-and-frame heat exchangers are more likely to leak at the external gaskets rather than internally between the high-pressure and low-pressure side. For spiral-plate heat exchangers, a gasket leak will short circuit the flow bypassing loops in the spiral so would not cause an overpressure. The welded-block heat exchanger does not have gaskets.

To evaluate the likelihood for an internal failure, a materials review should be done for new heat exchangers and inspection records should be evaluated for in-service heat exchangers. It may be possible to conclude that failure of the plate is so unlikely that no relief system design for plate failure is warranted. On the other hand, past internal leaks or materials susceptible to corrosion would indicate the need to evaluate an internal failure for relief system design. If there is any doubt regarding the likelihood of failure (LOF), then evaluate this scenario in the relief system design.

Rupture of an internal plate, in which a large quantity of high-pressure fluid flows to the lower-pressure heat exchanger side, is unlikely. Minor leakage can seldom overpressure a heat exchanger during operation; however, such leakage occurring where the low-pressure side is closed-in can result in overpressure. Loss of containment of the low-pressure side (including upstream and downstream systems) to atmosphere is unlikely to result from an internal plate rupture where the maximum possible pressure in the low-pressure side during the failure does not exceed the corrected hydrotest pressure (see 3.1.19 and 4.2.2). Pressure relief for an internal plate rupture is not required where the low-pressure heat exchanger side (including upstream and downstream systems) does not exceed this criterion. However, if the high-side maximum operating pressure can exceed the low-side maximum allowable accumulated pressure per the design code, the heat exchanger should be evaluated for a small internal leak on a plate. The use of maximum possible system pressure instead of design pressure may be considered as the pressure of the high-pressure side on a case-by-case basis where there is a substantial difference between the design and operating pressures for the high-pressure side of the heat exchanger. Leakage or failure of external gaskets may be a tolerable risk in some services (e.g. cooling water) but not in others (e.g. hydrocarbon, corrosive, toxic services) because of potential impacts of a release.

In contrast to a shell-and-tube heat exchanger, it is more difficult to determine an appropriate leak size for plate-and-frame, spiral-plate, and welded-block heat exchangers. One method would be to consider a hole size equivalent to a single tube rupture in a shell-and-tube heat exchanger [e.g. 6.4 mm to 25.4 mm (0.25 in. to 1 in.) in diameter]. Note that the flow would only be across one hole unlike a guillotine tube failure discussed in 4.4.14.2.2 where there are two "holes."

4.4.14.5 Sulfur Recovery Unit Thermal Reactor Waste Heat Steam Generators

4.4.14.5.1 General

A special case of heat transfer equipment failure involves a tube failure in a sulfur recovery unit (SRU) waste heat steam generator (WHSG). Generally, SRU designs are based on the modified Claus process with a thermal reactor that converts hydrogen sulfide to elemental sulfur operating near ambient pressure and at temperatures of about 925 to 1540 °C (1700 to 2800 °F). The shell side of the WHSG generates steam to cool the thermal reactor effluent gases containing elemental sulfur. WHSG steam-side design pressures range from about 345 to 5170 kPag (50 to 750 psig). The tube side design pressures might range from 105 to 1035 kPag (15 to 150 psig). In contrast to other shell-and-tube heat exchangers, tubes in these WHSG are typically larger [e.g. 50 to 150 mm (2 to 6 in.) in diameter] and fabricated from either schedule piping or boiler tubing. The process side of SRUs is designed with an open path to the atmosphere that can provide a relief path but some SRU designs contain switching valves that can block or restrict the open relief path to atmosphere.

4.4.14.5.2 Relief Protection Evaluation Procedure

PRVs, rupture disks, or other PRDs in a process containing elemental sulfur can be unreliable unless the pressure protection system is properly designed, installed, and maintained to hold the temperature high enough to prevent solidification of elemental sulfur upon cooling. This would result in a restriction or plugging of the PRD and/or the associated inlet and outlet piping. Further, atmospheric relief from a sulfur seal or sulfur pit vent in the vicinity of plant personnel is also a safety concern due to the potential release of molten sulfur along with high concentrations of H₂S and SO₂ gases. Instead of a PRD, it may be appropriate to provide overpressure protection by system design as the overpressure protection basis for the thermal reactor and other low-pressure side equipment in the SRU.

In order to specify appropriate overpressure protection, the type of WHSG internal failures must first be characterized. SRU WHSG tube failures are rarely full-bore tube ruptures^[101, 102] as seen in other shell-and-tube heat exchangers; however, such failures have been reported. More commonly, other failure mechanisms occur in multiple tubes (i.e. longitudinal cracks, multiple tube-to-tubesheet joint leaks, or a fish-mouth failure due to dimpled-in tube). The resultant net open area can be conservatively assumed equivalent to that of a full-bore tube rupture^[117]. A review of the industry data demonstrates that, while rare, loss of containment has been reported as a direct result of tube failure due to full-bore tube rupture and other failure mechanisms.

As a first step, the user may want to apply steady-state analysis techniques to determine if the process side of the SRU can pass a rate equivalent to the flow rate through double the cross-sectional area of a single tube without exceeding the corrected hydrotest pressure of the thermal reactor and other low-pressure side equipment. The user may choose a pressure other than the corrected hydrotest pressure, if a proper detailed analysis on all affected equipment shows that loss of containment is unlikely. As part of this analysis, the user shall evaluate leaks involving all steam (i.e. tube failure above the WHSG water level), all saturated water (i.e. tube failure below the WHSG water level), and a mixture of both. If the corrected hydrotest pressure is not exceeded, then the considerations given in 4.4.14.5.3 should be evaluated to minimize the potential for the failure mechanisms referenced above. The user shall also consider the potential consequences of process gas releases through paths such as sulfur seal system, sulfur pit vents, combustion air suction piping, or other locations.

If steady-state modeling shows the corrected hydrotest pressure can be exceeded, then additional considerations are necessary. For example, the designer may decide to utilize a more rigorous dynamic analysis. The user is cautioned against reducing WHSG tube diameter to avoid overpressure due to concerns of high heat flux occurrence at the end of the inlet ferrule^[138]. An alternative to dynamic analysis would be to provide overpressure protection by system design as the overpressure protection basis. The considerations given in 4.4.14.5.3 are to be used as part of the detailed analysis by a multidisciplinary team to determine the magnitude of a WHSG tube rupture and the impact of these mitigations to reduce the likelihood and consequences of a WHSG tube rupture.

4.4.14.5.3 Operational Considerations to Mitigate and Reduce the Potential for a WHSG Tube Failure

Operational considerations to mitigate and reduce the potential for a WHSG tube failure in SRU are given below. The user is cautioned that these considerations may not be an all-inclusive list.

Some operational considerations include:

- a) Continuously monitor the thermal reactor temperature.
- b) Maintain tubesheet refractory protective system (including ceramic ferrules) to avoid high-temperature sulfidation of the carbon steel tubesheet (consider tube mass flux limits) ^[137].
- c) Operate the thermal reactor within the temperature limits of the tubesheet protective refractory system to protect against:
 - 1) thermal shock;
 - 2) exceeding heat-up or cool-down rates of the refractory system;
 - 3) improper curing rather than following manufacturer's guidance.
- d) Maintain an effective blowdown strategy to ensure boiler feed water impurities are removed from the WHSG to avoid scale and sludge accumulation.
- e) Maintain the boiler feed water quality per ABMA guidelines ^[1, 118].
- f) Ensure the main steam stop check valves are regularly inspected to maintain reliability for avoiding reverse flow of steam from the plant header into the WHSG. Leaking main steam stop check valves will provide a continuing source of steam during a WHSG tube failure scenario (see 4.4.9.3).
- g) Provide guidance to operating personnel on the proper response to a loss of WHSG level as it relates to uncovering tubes and operating them dry. Establish administrative controls requiring cool down and inspection of WHSG if tubes have been operated below minimum required water level. Ensure that operating personnel are trained to avoid reintroducing water to hot exposed tubes that can result in a tube failure, shell failure, and/or steam explosion with possible loss of containment.
- h) Ensure operation with at least one open path to the atmosphere at all times. Maintain the permissives in the instrumented protective system to prevent an SRU blocked outlet.
- i) SIS and ignition control system shall be designed, operated, and maintained per ISA 84.01 ^[91]/IEC 61511 ^[89].

4.4.15 Utility Failure

4.4.15.1 General

The consequences that can develop from the loss of any utility service, whether plant-wide or local, shall be carefully evaluated. Cases of both the complete loss of a utility and the partial loss of a utility shall be considered. In some cases, a partial utility failure can cause a higher relief load than a total failure because some equipment that contributes to the relief load would remain in operation. Table 7 gives the normal utility services that can fail and a partial listing of affected equipment that can cause overpressure.

An evaluation of the effect of overpressure that is attributable to the loss of a particular utility service should include the chain of developments that can occur and the reaction time involved. In situations in which the equipment fails but operates in parallel with equipment that has a different energy source, operating credit may be taken for the unaffected and functioning equipment to the extent that service is maintained.

EXAMPLE 1 An example is a cooling-water circulating system that consists of two pumps in parallel service and continuous operation whose drivers have unrelated energy sources. If one of the two energy sources fails, partial credit can be taken for the other power source that continues to function (see 4.2). The quantity of excess vapor generated because of the energy failure then depends solely on the quantity and available head of the remaining cooling-water pump.

EXAMPLE 2 Another example is two cooling-water pumps in parallel service, with one pump providing the full flow of cooling water and the second being in standby service. The second pump has a separate energy source and is equipped with controls for automatic start-up if the first pump fails. No protective credit is taken for the standby pump because it is not considered totally reliable for the design of individual process equipment relief.

After detailed study, full or partial protective credit may be taken for parallel, normally operating instrument air compressors and electric generators that have two unrelated sources of energy to the drivers. Manual cut-in of auxiliaries is operator and time dependent and shall be carefully analyzed before it is used as insurance against overpressure.

4.4.15.2 Electric Power Failure

4.4.15.2.1 General

Determination of relieving requirements resulting from power failures requires a careful plant or system analysis to evaluate what equipment is affected by the power failure and how failure of the equipment affects plant operation. Automatic standby is an excellent method for maximizing the unit's on-stream time, minimizing unit upsets, and ensuring unit production rates. However, the circuitry, sequences, and components involved are not yet considered sufficiently reliable to permit credit for them in establishing individual relieving requirements.

4.4.15.2.2 Analysis

Electric power failure should be analyzed in the following three ways:

- a) as a local power failure in which one piece of equipment is affected;
- b) as an intermediate or partial power failure in which one distribution center, one motor control center, or one bus is affected;
- c) as a total power failure in which all electrically operated equipment is simultaneously affected.

The effects of a local power failure are easily evaluated when individual pieces of equipment, such as pumps, fans, and solenoid valves, are affected. Most of these effects are covered in other sections of this standard. Once the upsetting cause is resolved, the relieving requirements can be determined from these sections. For example, a pump failure can cause a loss of cooling water or a loss of reflux. For the effects of loss of reflux and/or cooling water and relieving requirements, see 4.4.3. Loss of absorbent is covered in 4.4.4.

Table 7—Possible Utility Failures and Equipment Affected

Utility Failure	Equipment Affected
Electric	Pumps for circulating cooling water/medium, boiler feed, quench, or reflux
	Fans for air-cooled heat exchangers, cooling towers, or combustion air
	Compressors for process vapor, instrument air, vacuum, or refrigeration
	Instrumentation
	Motor-operated valves
Cooling water/medium	Condensers for process or utility service
	Coolers for process fluids, lubricating oil, or seal oil
	Jackets on rotating or reciprocating equipment
Instrument air	Transmitters and controllers
	Process regulating valves
	Alarm and shutdown systems
Steam	Turbine drivers for pumps, compressors, blowers, combustion air fans, or electric generators
	Reciprocating pumps
	Equipment that uses direct steam injection
	Eductors
Steam/heating medium	Heat exchangers (e.g. reboilers)
Fuel (oil, gas, etc.)	Boilers
	Reheaters (reboilers)
	Engine drivers for pumps or electric generators
	Compressors
	Gas turbines
Inert gas	Seals
	Catalytic reactors
	Purge for instruments and equipment

Intermediate or partial power failure can cause more serious effects than either of the other two types of failure. Depending on the method of dividing various pumps and drivers among the electrical feeders, it is possible to lose all the fans at an air cooler at the same time that the reflux pumps are lost. This can, then, flood the condenser and can void any credit normally taken for the effect of natural convection of the air-cooled condenser.

Total power failure requires additional study to analyze and evaluate the combined effects of multiple equipment failures. Special consideration should be given to the effect of the simultaneous opening of relief valves in several services, particularly if the relief valves discharge into a closed header system.

4.4.15.3 Loss of Heat

4.4.15.3.1 Loss of Heat in Series Fractionation Systems

In series fractionation (i.e. where the bottoms from one column feed into another column), the loss of heat input to an upstream column can overpressure the downstream column. Loss of heat results in some of the light ends mixing with the bottoms and being transferred to the next column as feed. Under this circumstance, the overhead load of the downstream column can consist of its normal vapor load plus the light ends from the first column. If the downstream column does not have the condensing capacity for the additional vapor load, excessive pressure could occur.

4.4.15.3.2 Loss of Heat in Other Equipment

In cases where loss of heat can cause carryover of lighter ends, the potential for downstream equipment overpressure should be considered.

4.4.15.4 Loss of Instrument Air or Electric Instrument Power

4.4.15.4.1 General

The loss of instrument air drives all air-operated valves to their specified fail position. This action of many valves can result in overpressure if the specified failure positions of the valves are not selected to prevent overpressure. Likewise, failure of electric instrument power can drive control systems and electrically operated valves to their specified failure positions. Consideration should be given to the effect on flare or vent system loading of valves failing open or closed due to instrument air failure or power failure.

4.4.15.4.2 Cautions for Double Actuated Valves

Double actuated valves use instrument air to drive the valve to its specified failure position. Typical designs have an instrument air pressure reservoir (air bottle) and utilize pilot valves to re-route the instrument air to drive the valve to its specified failure position. Double actuated valves can be less likely to move to the specified failure position than spring actuated valves during an instrument air failure [for example, a latent failure of the pilot valve could cause the double actuated valve to not move on loss of instrument air (see 4.2.4)]. Consideration should be given to the effect on flare or vent system for the valve moving to a position other than its specified failure position.

4.4.16 Overpressure Prevention During Maintenance

Relief devices, open vents, mechanical interlocks, and/or administrative procedures shall be in place to ensure that equipment is not overpressured during maintenance. If, during maintenance, a relief device is isolated from protected equipment and no open vent is available, then administrative controls shall be in effect to prevent overpressure above allowable accumulation pressure. If open vents are used as the relief path during maintenance, they shall have adequate capacity.

All sources of overpressure during maintenance shall be reviewed. Some common causes of overpressure are listed below. This list may not include all possible causes:

- a) introducing a high-pressure fluid into the equipment under maintenance;
- b) introducing a fluid or energy source that can react with fluid that may be left in the equipment;
- c) introducing a high-temperature fluid that can vaporize a fluid that may be in the vessel;
- d) isolation valves that are closed rather than open;
- e) unexpected plugging in the equipment;
- f) steaming the vessel;
- g) purging the vessel;
- h) external fire scenario.

Note that if there is an inadequate source of fuel or the equipment is drained, then external fire does not have to be assumed a cause of overpressure during maintenance. In general, procedures should dictate that all equipment be drained for maintenance. The maintenance procedures should clearly state if this is not the case and why.

Steaming the vessel can produce either an overpressure or a vacuum condition. Where an open path is unavailable, administrative controls are generally used to prevent an overpressure, particularly for uninsulated equipment where an overpressure within a practical time period may be unlikely due to system heat losses. See 4.5 for a discussion of vacuum protection.

A similar scenario involves the use of nitrogen to air-free vessels. If an open flow path of adequate capacity is unavailable and if the nitrogen supply pressure can exceed the maximum allowable accumulated pressure, then either administrative controls or a PRD should be designed to prevent overpressure for the scenario.

4.4.17 Piping Design Considerations

Certain scenarios such as inadvertent valve opening (see 4.4.9.2) and vapor breakthrough (see 4.4.8.3 and 4.4.8.7) can result in slug flow and high flow velocities in the piping between the locations of vapor breakthrough or inadvertent valve opening and the inlet to the PRD. The resultant dynamic (transient) loads on the process and PRD inlet piping should be taken into account, including the mechanical design and pipe supports.

4.5 Guidance on Vacuum Relief

4.5.1 General

The fundamental heat-and-material balance factors that can lead to an increase in operating pressure are described in 4.4. Under different circumstances, the same factors can lead to a fall in operating pressure to the extent that vacuum relief is required to prevent the equipment from failing under vacuum.

Large vessels and equipment designed for low positive pressures are more susceptible to vacuum, as smaller vessels often have an inherent vacuum design capability due to other design requirements. Although there is substantial evidence of damage to storage tanks as a result of vacuum, serious damage has also occurred on process vessels ^[147].

If equipment contains internal partitions, the potential for a vacuum condition existing in one of the compartments should be considered. This also includes shell-and-tube heat exchangers designed on the basis of a limiting pressure differential across the tubesheet. If the pressure on one side falls to a vacuum condition, the differential pressure limit can be breached.

4.5.2 Causes for Vacuum

A vacuum can potentially result when the following occurs, singly or in combination:

- a) the volumetric outflow of material from the protected system exceeds the inflow;
- b) the energy outflow from the protected system exceeds the energy inflow or a phase change occurs resulting in material changing from a phase with a higher specific volume to a phase with a lower specific volume.

Examples of possible causes of vacuum include the following:

- a) removal of liquid from a vessel due to pump-out, siphoning, or gravity drainage;
- b) removal of vapor from a vessel by attachment to pumps/compressors or by attachment to equipment capable of pulling a vacuum (whether by design, such as vacuum pumps and ejectors, or inadvertently such as vent-collection systems where the flow of material along a header can induce a vacuum in other equipment);
- c) ambient temperature changes, resulting in contraction of the vapor space; this is normally only a significant issue for storage tanks (see API 2000 ^[11]);

- d) condensation of vapor, whether by ongoing heat transfer through a condenser (e.g. following loss of reboil to a distillation or regeneration column), by gradual heat transfer (e.g. cooling of equipment following steam-out or plant shutdown), or by injection of cold material into the vapor space (e.g. following a loss of preheat);
- e) physical absorption or adsorption, for example, the ongoing absorption of a soluble vapor into a liquid (e.g. ammonia into water) following a shutdown or through the inadvertent entry of a suitable absorbent into the process;
- f) chemical absorption, for example, the ongoing absorption of sour gas or carbon dioxide into a scrubbing solution;
- g) other chemical reactions that remove gas or vapor from the vapor space (e.g. the removal of oxygen to form rust in an isolated item of equipment);
- h) inadvertent blockage of vents designed to allow inflow of gas or vapor to prevent a damaging vacuum from forming. This is principally an issue for storage tanks (see API 2000). Typical problems arise from covering or blocking vents during maintenance and not reinstating the vent afterwards, using a lute or seal pot to minimize emissions from a vent but thereby preventing gas or vapor from flowing through the vent to mitigate a vacuum and not draining banded areas so that liquid can cover vent lines that have been brought to grade.

4.5.3 Protection Against Vacuum

Protection against vacuum typically takes one or more of the following forms:

- a) operating procedures;
- b) mechanical design, the most robust form of protection;
- c) relief system design, often only practicable with low-pressure equipment and relying on suitable designs of PRV or atmospheric vent;
- d) instrumented protective system, designed to admit a gas into the protected system to prevent the vacuum from exceeding a specified level.

The simplest solution to a potential vacuum is to design the equipment to withstand full vacuum. This option should always be considered for new equipment. Although smaller equipment can come with a degree of inherent mechanical strength against vacuum, provision of vacuum design for larger equipment can require additional metal thickness or the provision of vacuum support rings. The latter introduce potential corrosion problems unless suitable provision is made for liquid to drain from the rings and the drain holes are kept clear.

Operating procedures are sometimes relied upon for activities associated with preparation for maintenance (e.g. vessel draining and steam-out) and activities such as hydrotesting. However, they are not a foolproof form of protection and designers and operators should agree where procedures can safely be relied upon.

If a vacuum-relief device is used, it should be set at a pressure and have a capacity rating to prevent the vacuum rating of the protected equipment from being exceeded.

An instrumented system or regulator (repressuring system) can be used to add gas to prevent the vacuum from exceeding a specified level. The choice of gas should be considered carefully—air, nitrogen, and fuel gas are commonly used, but each introduces different factors of cost, potential product contamination, and flammability.

Instrumented protective systems (whether through process control or by a high-integrity protection system (HIPS)) are often used to protect pressurized equipment such as distillation columns against vacuum. The philosophy is essentially the same as for the use of relief devices—to admit a suitable gas into the protected equipment to prevent the vacuum from exceeding a defined level. The same considerations about the selection of gas apply. It is unlikely that a simple control scheme has sufficient reliability to be regarded a suitable form of protection; a HIPS (see Annex E) is likely to be required with the attendant requirements of regular proof testing.

If admission of a suitable gas is relied upon for controlling the level of vacuum in the process, calculation of the required rate can prove problematic, especially as the calculation is for a transient condition rather than a steady-state condition. Suitably conservative assumptions about heat transfer rates and compositions should be made and the calculations can prove very complex.

If mechanical design for a pressure other than full vacuum is used, the level of vacuum should be justified by appropriate calculations. It might be possible to show that a vacuum cannot be generated (e.g. because the vapor pressure of the liquid remains above atmospheric).

4.6 Vapor Depressuring

4.6.1 General

Depressuring systems can be used to limit the consequences of a vessel leak or failure by reducing the leakage rate and/or inventory within the vessel. More often, depressuring systems are used to reduce the failure potential for scenarios involving overheating (e.g. fire). When metal temperature is increased due to fire or exothermic or runaway process reactions, the metal temperature can reach a level at which stress rupture can occur. This can be possible even though the system pressure does not exceed the maximum allowable accumulation. In this case, depressuring reduces the internal stress, thereby extending the life of the vessel at a given temperature.

Unless special provisions are made, a PRV cannot provide depressuring; it merely limits the pressure rise to a given value under emergency conditions. A rupture disk device may burst at a lower pressure if it is heated by the fire depending upon the specified burst temperature and provide a means of depressurization. If depressuring valves are used, see the guidance in 4.2.6.

4.6.2 Initiation of Depressuring

Fast and effective emergency depressuring may reduce the leakage rates, reduce the duration and severity of a fire and prevent vessels and pipe from rupturing, thereby reducing the risk to people as well as limiting material and environmental damages. Emergency depressuring may be initiated manually by operator or automatically by process instrumentation, ESD/ESSs, SIS, a signal from the fire and gas (F&G) detection system, etc. Equipment vendors may also specifically require automatic initiation of depressurization (e.g. compressor in case of seal failures).

Automatic depressuring initiated by the F&G system provides a fast reduction in pressure upon confirmed detection of gas or fire, and should be considered. Among the things to consider are spurious initiation, criticality and consequence of an unintended shutdown, type of F&G detectors, detector voting, and need for overrides during operation and maintenance. A time delay may be implemented to allow for operator intervention, thereby avoiding spurious initiation of the depressuring function.

If manual or time-delayed depressuring is used, the piping/vessel may be exposed to fire for some period before depressuring is initiated and the user should consider if it is desirable to reduce the depressuring time interval (starting from the opening of the depressuring valve and ending when the system reaches the specified target pressure) to a duration shorter than the time intervals specified in 4.6.6.

4.6.3 Low Temperatures During Depressuring

Many light hydrocarbons chill to low temperatures as pressure is reduced. Design and depressuring conditions should consider this possibility. Materials exposed to temperatures below the specified minimum design temperature may suffer permanent damage or brittle failure, depending on the mechanical stresses present in areas subjected to low temperatures. Low temperatures can occur both upstream of the depressuring valve in the protected system as well as downstream in the discharge piping.

A detailed analysis may be required to determine the minimum temperature occurring during depressuring. The effects of chilling will typically be influenced by factors such as the initial pressure and temperature, fluid composition, depressuring rate, mass of the containing piping/vessel, heat transfer between the fluid and the containing piping/vessel, and heat transfer between the piping/vessel and the surroundings.

Depressurization with no heat transfer to/from the depressured volume will typically approach an isentropic process. The minimum temperature during depressuring may be roughly estimated by reading fluid properties from a property chart or applying a flash algorithm with an assumed isentropic efficiency for the expansion process. Suitable process simulation software tools are useful to establish a more exact calculation of minimum temperature particularly where credit is taken for vessel wall heating from the surroundings (i.e. the minimum design temperatures is not based on the lowest estimated fluid temperatures). In these cases, rigorous modeling techniques (e.g. time-dependent nonlinear thermomechanical analysis) are recommended, particularly where predicted temperatures may be close to material selection limits (e.g. between carbon steel and stainless steel). The detailed analysis will typically take into account all of the above-mentioned factors that influence the chilling effect. Such analysis will produce a transient temperature profile in the depressured volume, and the corresponding temperature profile for the fluid flow in the discharge system may be calculated. The wall temperature in the piping/vessel may approach the fluid temperature in sections of the volume where the velocity of the flowing vapor is high and in other sections with high local heat transfer coefficients.

Depressuring high-pressure volumes containing vapor only (especially dense phase, i.e. supercritical) requires special consideration, as liquid may be condensed as a result of decreasing pressure. The liquid may accumulate in the low points (e.g. bottom of vessels, drain connections). The vessel/piping wall may be at a higher temperature than the liquid, causing liquid boiling in these low points and low local temperatures. A detailed analysis may be required to determine the minimum temperature in such cases.

If the fluid temperature during normal operation is higher than ambient temperature, the user should consider the possibility that the volume has been shut in and chilled to ambient conditions before depressuring is initiated. Note that this temperature reduction will be accompanied by a corresponding reduction in the initial pressure. The minimum temperature during depressurization may be limited by operational procedures that ensure that depressuring is initiated before the fluid is cooled to ambient conditions. If depressuring has caused cooling of the vessel/piping to a temperature at which it cannot withstand normal operating pressure, it may be necessary to allow the system time to heat-up before a restart. Application of materials suitable for low-temperature conditions should be considered to eliminate the need for operational procedures.

4.6.4 Application Criteria

A common application is compressor depressurization, in case of a fire, leakage, or seal failure. Another is emergency depressuring for the fire scenario, which is often considered for large process equipment operating at a gauge pressure of 1700 kPa (~250 psi) or higher. This can vary from installation to installation (i.e. it may be different for normally unmanned, remote installation compared to an installation located in populated areas; whether the fluid is LPG, gas, or oil; whether the fluid is toxic or not, etc.). Because the consequences of a vessel rupture (fragmentation and possible BLEVE) normally are larger than for a pipe rupture, pipe rupture can be more acceptable than a vessel rupture. In addition, the user should consider the following when deciding whether these criteria are suitable for their needs:

- a) personnel exposure (time to escape, time for rescue actions);
- b) potential asset damage;
- c) potential for escalation;
- d) potential offsite effects;
- e) loss of production, reputation;
- f) other measures to mitigate overheating due to fire exposure;
- g) frequency of the fire scenario (i.e. risk analysis).

4.6.5 Acceptance and Design Criteria

If a depressurization system is selected as a means of protection against the fire scenario, then in order to be effective, the depressuring system should depressure the exposed equipment such that the reduced internal pressure keeps

the stresses below the rupture stress or until the acceptance criteria for rupture are reached. The following should be considered for determining the acceptance criteria for rupture and, therefore, the depressuring rate:

- a) tolerable time to rupture (affected by time for personnel escape and/or rescue actions);
- b) rupture pressure of vessels (escalation, fragmentation);
- c) rupture pressure of pipes (escalation);
- d) tolerable amount of flammables or toxics that can be released upon rupture (escalation);
- e) instantaneous release rate upon rupture (sudden increase in fire size during evacuation or rescue);
- f) loss of production, reputation, and rebuild cost;
- g) damage to internals of equipment (e.g. trays, packing supports), entrainment of packing or catalyst into the depressurization system;
- h) brittle failure due to cooling.

In general, the depressurization rates should be maximized while recognizing that there will be system constraints such as:

- a) total flare system capacity (i.e. the sum of all required simultaneous depressurization, concurrent relief rates, and other sources)—for further information see 5.3;
- b) vessel internals (e.g. damage to tray supports, packing materials, catalyst beds, adsorbent materials);
- c) material suitability at reduced temperatures (many light hydrocarbons chill to low temperatures as pressure is reduced);
- d) thermal stresses due to temperature change;
- e) maximum allowable rates for rotating equipment.

Where installed, passive fire protection (PFP) can reduce the size or eliminate the need of the depressurization system.

The design of depressuring systems should also recognize the following factors.

- a) Controls near the vessel may be inaccessible during a fire.
- b) Failure position (i.e. open or last position) of the depressuring valve is selected in order to maximize availability by the use of a fail-open valve or a fail-last position valve equipped with a backup utility supply (e.g. UPS or local instrument air bottles) and fireproofing.
- c) Selection of failure position should ensure that the flare capacity is not exceeded and avoid excessive environmental impact in the event of an instrument air failure by, for example, using staggering logic or restriction orifices. If a staggering logic is used to prevent exceeding the flare capacity with fail-open or fail-last position depressuring valves, then a review of potential common mode scenarios whereby multiple (or all) of the depressuring valves open simultaneously may be needed. Scenarios to consider include failure of the logic processor, simultaneous failure of utility and backup, human/design error where multiple zones are simultaneously initiated. If there are multiple fail-open depressuring valves whose opening would exceed flare capacity, then backup utility supply should be considered. Alternatively, local air accumulators can be used to mitigate the effects of loss of instrument air by providing sufficient instrument air on selected depressuring valves to delay their opening.
- d) Early initiation of depressuring is desirable to limit equipment stress to acceptable levels commensurate with the equipment wall temperature that can result from a fire.
- e) Safe disposal of vented streams shall be provided.
- f) Safeguards may be required to prevent repressuring of the system if the materials of construction are still within the embrittlement zone from cooling.

The effect of heat input to process vessels is further discussed in 4.4.13.2, 4.6.7, and A.3.5.4.6.

4.6.6 Depressuring Rate

In the case of protecting vessels exposed to fire, a vapor depressuring system should have adequate capacity to permit reduction of the vessel stress to a level at which stress rupture is not of immediate concern. For pool fire exposure, this generally involves reducing the equipment pressure from initial conditions to a level equivalent to 50 % of the vessel's design pressure within approximately 15 min. This criterion is based on the vessel wall temperature versus stress to rupture and applies generally to carbon steel vessels with a wall thickness of approximately 25.4 mm (1 in.) or more. The vessel material and thickness influence the depressurization rate needed to avoid rupture (e.g. vessels with thinner walls generally require a faster depressurization rate). For vessels other than 25.4 mm (1 in.) carbon steel, the user may choose to apply the 50 %/15 min criterion, or some other criterion, or may choose to perform more specific calculations; A.3.5.4.6 provides a method that may be used for more specific calculations involving pool fires as well as jet fires.

If the equipment contains liquid, then the depressuring rate is the rate of vapor formed from boiling due to fire heat input and an additional rate to further reduce the pressure with time.

In the case of protecting compressor systems, a depressuring time of several minutes is often used to mitigate a seal failure. However, depressuring at too high of a rate could damage the compressor seals. The manufacturer should be contacted to determine the depressuring rate for the specific compressor system.

Depressuring is assumed to continue for the duration of the emergency. The valves should remain operable for the duration of the emergency or should fail in a full-open position. Otherwise, fireproofing of the control signal and valve actuator or other protective measures (e.g. locate the valve, valve actuator, and control signals outside the fire area) to ensure the appropriate operability of the valve during a fire requires consideration.

Depressuring to a gauge pressure of 690 kPa (100 psi) in 15 min is commonly considered when the depressuring system is designed to reduce the consequences from a vessel leak or failure. This criterion is also commonly applied for both fire and leak scenarios. Controlled depressuring also guards against the potential of adding fuel to the fire should the vessel rupture, thereby reducing the fire duration or severity. The reduced pressure permits somewhat more rapid control of the situation in which the source of fire is the leakage of flammable materials from the equipment being depressurized. The fire scenario results in a higher depressurization rate than the nonfire case, whereas the nonfire case could result in the need for materials suitable for lower temperatures. If vapor depressuring is required for fire, leakage, and/or process reasons, the larger requirement usually governs the size of the depressuring facilities.

Depressuring criteria other than those given above can be used depending upon the specific circumstances and user-defined requirements. For example, if there is a reactive hazard or other exceptional hazard that can cause loss of containment due to overtemperature, emergency depressuring can be appropriate for equipment designed for a wider range of pressures than that noted above. See 4.4.11 for guidance on how to estimate the vent size and temperature rise in a reactive system.

Mitigation measures for equipment that can be exposed to a fire often include equipment design, equipment layout, structural fireproofing, area-drainage design, firewater-system design, emergency response capabilities, emergency isolation, and/or emergency depressuring. It is necessary that the user assess how effective the site-specific mitigation measures can be when determining the appropriate emergency depressuring criteria.

Depressuring disposal systems are discussed in 5.3.3.

4.6.7 Vapor Flows

4.6.7.1 General

To reduce the internal pressure in equipment involved in a fire, vapor should be removed at a rate that compensates for the following occurrences:

- a) vapor generated from liquid by heat input from the fire;
- b) vapor expansion during pressure reduction;
- c) liquid flash due to pressure reduction (this factor applies only when a system contains liquid at or near its saturation temperature).

The total vapor load for a system to be depressurized may be expressed as the sum of the individual occurrences for all equipment involved. Thus, in terms of the loads in Items a) through c), the total mass, m , equals Item a) plus Item b) plus Item c) as given by Equation (24):

$$\dot{m} \times t = \sum_{i=1}^{V_T} (q_{m,f} \times t)_i + \sum_{i=1}^{V_T} (q_{m,d} \times t)_i + \sum_{i=1}^{V_T} (q_{m,v} \times t)_i \quad (24)$$

NOTE The variables for all equations in 4.6.7 are defined in 4.6.7.4.

The combined expression, $\dot{m} \times t$, is used because \dot{m} represents a flow rate per unit of time, and some of the noted vapor quantities are mass quantities that are not influenced by time, namely $q_{m,v} \times t$ and $q_{m,d} \times t$ (the vapor loads from density change and liquid flash). If the system to be depressurized includes more than one vessel, the vapor quantities for each vessel under all three occurrences should be calculated, especially if different relative molecular masses, latent heats, insulation thicknesses, and vaporization temperatures are involved. The average relative molecular mass and temperature for $\dot{m} \times t$ (the total vapor relieved from the whole system) should be calculated from the total individual vapor relative molecular masses and vapor temperatures involved. The vapor loading on the depressuring system for each of the terms in Equation (24) is described in 4.6.7.2 through 4.6.7.3.

4.6.7.2 Vapor from Fire Heat Input

The heat input to equipment during a fire is generally calculated in accordance with Equation (7) or Equation (8) in 4.4.13.2.4; however, the following modifications and limitations can be used to compute loads for a vapor depressuring and pressure-relieving system under fire conditions.

- a) The extent of an assumed fire zone is a function of the design and installation features that permit confining a fire within a given area. Although the size of the assumed fire zone can vary, experience generally indicates that a fire that can be confined to a ground area of 230 m² to 460 m² (2500 ft² to 5000 ft²) of plot area will not affect the design of the main relief headers in processing areas where a depressuring flow discharges into the same relief header. See 5.3.2 for additional discussion.
- b) Additional insulation or an increase in the thickness of insulation on individual vessels may also be considered as a means of reducing vapor generation resulting from exposure to fire.
- c) During a fire, all feed and output streams to and from the system to be depressurized and all internal heat sources within the process are assumed to have ceased. Thus, the vapor generation is a function only of the heat absorbed from the fire and the latent heat of the liquid.
- d) The analytical method discussed in Annex A can be used as an alternative to Equation (7) or Equation (8) in 4.4.13.2.4.

To calculate the vapor load generated by fire, the fire should be assumed to be in progress throughout the depressuring period. The mass, m_f , of vapor generated by the fire during the depressuring interval in a vessel, i , of the system can be determined by Equation (25):

$$(m_f \times t)_i = t(Q / L)_i \quad (25)$$

This calculation should be repeated for all vessels in the system if significant differences in vapor and liquid properties are involved.

4.6.7.3 Vapor from Density Change and Liquid Flash

The calculations of vapor loads caused by vapor density change and those that result from liquid flash cannot be completely separated. To determine the vapor quantities contributed by these causes, it is necessary to know the liquid inventory and vapor volume of the system. This includes all liquid and vapor in any directly connected facilities outside the fire area that cannot be isolated under fire conditions, as well as all liquid and vapor contained in equipment located in the assumed fire area. Although liquid inventory and vapor volume depend on plant design, the following assumptions may be made to estimate these values.

- a) The liquid inventory of fractionating columns can be estimated as the normal column bottom and draw-off tray capacity, plus a holdup per tray, equal to the weir height plus 50 mm (2 in.), or its design quantity, if known.
- b) Normal operating levels may be used as the basis for computing the inventory of accumulators.
- c) To obtain an initial, rapid approximation for standard shell-and-tube heat exchangers, one-third of the total shell volume should be assumed to be occupied by the tube bundle. For condensers and heat exchangers in vaporizing service, 80 % of the volume involved should be assumed to be vapor. The remainder should be assumed to be liquid.
- d) All liquid in heaters should be included in the estimate, regardless of temperature. If the heater is in vaporizing service, one should assume 80 % of the tube volume past the normal point of vaporization to be vapor.

Only after the vapor and liquid volumes in the system have been determined can one estimate the respective loadings they contribute to depressuring.

One can determine the mass of vapor to be removed from a given vapor space in a vessel, i , to compensate for the reduced vapor density at the lower pressure by using Equation (26) or Equation (27).

In SI units:

$$(q_{m,d} \times t)_i = 0.1205 \times V_i \left[\left(\frac{p \times M}{Z \times T} \right)_a - \left(\frac{p \times M}{Z \times T} \right)_b \right]_i \quad (26)$$

In USC units:

$$(q_{m,d} \times t)_i = 0.0932 \times V_i \left[\left(\frac{p \times M}{Z \times T} \right)_a - \left(\frac{p \times M}{Z \times T} \right)_b \right]_i \quad (27)$$

where the subscript "a" represents the higher-pressure condition and "b" represents the lower-pressure condition.

Note that V_i is assumed not to increase significantly as a result of liquid flash. This calculation should be repeated for each vessel in the system if different vapor properties are involved.

Since the calculation of the vapor load caused by liquid flash depends on liquid quantity and liquid properties in the system, the preceding data are also valid for this calculation. In systems that contain liquid at saturation conditions, the temperature of the liquid should be reduced to obtain the required reduction in pressure. To reduce pressure, one can remove vapor at a rate equal to the vapor-generation rate created by heat input from the fire to compensate for the flash vaporization of some liquid. Without this allowance for flash vaporization, the required reduction in pressure is not possible. It is necessary to consider only the liquid inventory that is at or near its saturation temperature for liquid flash. Two methods are shown for calculating the rate at which it is necessary to withdraw vapor in order to reduce the temperature within a time interval, t , to a point at which the corresponding liquid vapor pressure equals the desired final pressure. The first method applies only to relatively pure chemicals and to narrow-boiling-range hydrocarbons; the second covers liquids that consist of mixtures of hydrocarbons with a wider boiling range. For pure chemicals or hydrocarbons with a narrow boiling range, the amount of liquid flash in a vessel, i ,

of the system may be conservatively approximated by equating the heat of the flashed vapor with the heat loss of the average liquid quantity as shown in Equation (28):

$$(q_{m,v} \times t)_i \times \lambda_i \approx \left[(q_{m,a} \times t) - \frac{Q_i \times t}{2\lambda_i} - \frac{(q_{m,v} \times t)_i}{2} \right] (C_p)_i (T_a - T_b)_i \quad (28)$$

Rearranging Equation (28) as follows in Equation (29) yields the amount of liquid flash:

$$(q_{m,v} \times t)_i \approx \left[(q_{m,a} \times t)_i - \frac{Q_i \times t}{2\lambda_i} \right] \times \left[\frac{2(C_p)_i (T_a - T_b)_i}{2\lambda_i + (C_p)_i (T_a - T_b)_i} \right] \quad (29)$$

NOTE $(q_{m,a} \times t)$ is used only for consistency, and $q_{m,a}$ has no physical significance.

If a more rigorous calculation is desired, the same approach may be applied in stepwise form.

Equation (29) cannot be used for liquids consisting of a mixture of hydrocarbons that have a wide boiling range because the liquid properties and composition change as the liquid is vaporized. If more accurate fluid data are not available, a series of simplified adiabatic flash calculations should be made between the initial pressure and the final pressure, while neglecting the simultaneous fire effect. The simplified adiabatic flash calculation is a stepwise procedure that, by repeatedly applying Equation (30), yields a mass fraction flashed from the liquid quantity that was originally in the system during the required pressure decrease. This process assumes that the vapors flashed in each step are totally removed from the system to be depressurized before the next step occurs. The correction for the fire is made in Equation (31) in which the average of the remaining liquid quantity is used (i.e. the original liquid quantity in the system minus half of the quantity vaporized by fire during the total depressuring period) instead of the total liquid quantity that was originally in the system. This compensates to some extent for neglecting the fire-vaporization effects on the composition for each flash step.

To determine the approximate amount of liquid vaporized from a mixture, an equilibrium-phase diagram is required and a graphical solution employing n steps is employed. The procedure uses Equation (30):

$$(\Delta T_n)_i = \left[\frac{L_n (\Delta q_{m,v} \times t)_n}{\left((q_{m,L} \times t)_{n-1} - (\Delta q_{m,v} \times t)_n \right) \times (C_p)_n} \right]_i \quad (30)$$

For convenience, the mass percent vaporized is assumed to be equal to the volume percent vaporized. By assuming that an incremental part of the liquid (e.g. 5 %) is vaporized during each step, the change in the liquid temperature can be computed using Equation (30). Because the remaining liquid has a saturation temperature and pressure along the 5 %-vaporized line of the phase diagram and the temperature change has been determined using Equation (30), the pressure change is also known. The process is repeated in incremental steps until the pressure, p_b , at the end of the depressuring period is obtained. The mass fraction, X_i , of the initial liquid in the vessel, i , at the pressure p_b is determined from the phase diagram. Substituting this value of X_i into Equation (31) for the last term in Equation (29) gives the estimated mass of liquid flashed as a result of the depressuring from the vessel, i , of the system during a simultaneous fire.

$$(q_{m,v} \times t)_i \approx \left[(q_{m,a} \times t)_i - \frac{Q_i \times t}{2L_i} \right] w_i \quad (31)$$

An example flash calculation is given in C.1.

4.6.7.4 Nomenclature

The variables used in the equations throughout 4.6.7 and C.1 are defined as follows:

- C_p is the average specific heat of the liquid, expressed in kJ/kg·K (Btu/lb·°R);
- L is the average latent heat of the liquid, expressed in kJ/kg (Btu/lb);
- m is the mass of liquid or vapor, expressed in kg (lb);
- \dot{m} is the mass flow rate per unit time;
- M is the relative molecular mass of the vapor;
- p is the absolute pressure, expressed in kPa (psi);
- q_m is the vapor mass flow rate, expressed in kg/h (lb/h);
- Q is the total heat absorption (input) to the wetted surface, expressed in kJ/h (Btu/h);
- T is the absolute temperature of the liquid or vapor, expressed in K (°R);
- t is the depressuring time interval, expressed in hours (usually assumed to be 0.25 h);
- V is the volume available for the vapor, expressed in m³ (ft³);
- V_T is the total number of vessels in the depressuring system;
- w is the mass fraction of the initial liquid in the system vaporized as a result of depressuring, dimensionless;
- Z is the compressibility factor, dimensionless;
- λ is the latent heat of the liquid, expressed in kJ/kg (Btu/lb);
- Δ represents a difference, for example, as in $\Delta T_n = T_{n-1} - T_n$.

The subscripts used in the equations throughout 4.6.7 and C.1 are defined as follows:

- a is the original condition at the start of the depressuring time interval, assumed to be the saturated vapor-liquid equilibrium condition with respect to temperature and pressure;
- b is the depressurized condition at the end of the depressuring time interval;
- d relates to the density change of the vapor due to pressure reduction;
- f relates to vaporization from the fire;
- i relates to an individual vessel of the system if more than one vessel is involved and requires separate consideration because of differing fluid properties, insulation for fire effect, or related factors;
- L relates to liquid;
- n is the n th depressuring step of many steps between the original condition and the depressurized condition;
- $n - 1$ is the depressuring step preceding Step n ;
- v relates to liquid flash or vapor generated from pressure reduction;

4.7 Relief System Design Documentation

4.7.1 General

This standard covers a wide variety of systems, types of protective devices, protection methods, fluids, processes, and equipment. Hence, it cannot prescribe mandatory requirements for pressure-relief system design documentation. Systems have different documentation needs. In some cases, specific documentation elements are not applicable for certain relief systems. Specific company or site requirements may differ from, supplant, or supplement the practices described below. Therefore, it is the user's responsibility to determine the documentation requirements for each relief system. In addition, it is the user's responsibility to determine how the documentation is managed (e.g. hard copies and/or electronic storage; central file location or distributed in several locations at the site). The documentation should be maintained for the life of the relief system.

4.7.2 Purpose of Documentation

4.7.2.1 General

A facility's documentation allows the user to determine that the facility was designed in accordance with relevant codes and standards. The relief system design documentation is one facet of the overall documentation that helps demonstrate that the process can be operated in a safe manner.

4.7.2.2 Supports to Process Hazard Analyses and Audits

Complete and accurate relief system documentation facilitates studies [e.g. PHA], reviews, and auditing processes.

4.7.2.3 Facilitation of Management of Change

Documentation of the relief system design basis makes it easier to determine what relief system changes may be required as a consequence of an equipment, operation, or process modification. The MOC process and documentation of relief systems are interdependent. Equipment modifications, operations, or changes made to process parameters can have a direct impact on the relief system.

4.7.2.4 Provision of a Record of the Current Relief System

Management of relief system documentation helps eliminate the duplication of effort. Readily available documentation facilitates answering questions that arise during operations, analyses, inspections, and modifications.

Relief system design documentation on projects should be developed during the project execution and not created as an afterthought after the project has been completed. At the completion of plant modifications, the documentation should be updated to reflect "as-built" conditions including any changes in process conditions. The documentation should be incorporated into the existing documentation system.

Audits or reviews of the relief system design basis can verify that information is up-to-date and the design is adequate for the current plant configuration and operating conditions.

4.7.3 Potential Elements of Relief System Design Documentation

4.7.3.1 General

The relief system documentation should demonstrate that all pressure-containing equipment has been identified and the relief requirements analyzed. Documentation based on the protected systems can help ensure that all systems requiring pressure protection have been identified. Documentation should show that potential causes of overpressure have been identified, rationale has been provided as to whether a scenario is or is not credible, and credible causes of overpressure have been evaluated.

4.7.3.2 Documentation of User Relief System Design Guidance

This standard does not prescribe specific parameters or relief design methods for all processes, equipment, and overpressure scenarios. Further, the user may have different approaches to evaluating aspects of relief system design than the approaches in this standard. Hence, the user is responsible for documenting specific engineering guidance on the relevant designs, methodology, and documentation where the approach is not defined or is different from this standard. The user can document these within each relief device file, each protected system file, or an internal specification or guidance document for a project, unit, site, or corporation.

Common examples of guidance that may need to be defined often include, but are not limited to, the following:

- a) identification and definition of credible causes of overpressure;
- b) guidance for evaluating control valve bypasses;
- c) credit for operator intervention, for example, to stop a liquid overflow situation;
- d) credit for check valves and sizing procedures for backflow through pumps;
- e) credit for vessel insulation and adequate drainage for the fire case;
- f) determination of physical properties (e.g. heat of vaporization of mixtures);
- g) fire sizing for air coolers;
- h) required pump impeller size to use in blocked discharge scenario;
- i) control valve trim size;
- j) credit for sealed or locked open isolation valves in the pressure-relief path;
- k) guidance related to double jeopardy;
- l) credit for protective instrumentation;
- m) guidance on heat exchanger internal failure scenario;
- n) use of administrative controls to eliminate specific overpressure scenarios.

4.7.3.3 Documentation of References Used in the Relief System Study

All references used in the relief load calculations should be documented. Common examples of references include, but are not limited to:

- a) process unit description;
- b) unit capacity and feedstock definition;
- c) heat and material balances;
- d) user relief system design guidance as discussed in 4.7.3.2.

4.7.3.4 Protected Equipment or System

The following documentation related to the protected equipment or system should be available:

- a) equipment unique identifier(s) and description(s);
- b) piping and instrumentation diagrams (P&IDs) and process flow diagrams (PFDs);
- c) equipment design conditions, including design pressure, temperature, and mechanical data (e.g. dimensions);
- d) code of construction (e.g. ASME *BPVC*, Section VIII);
- e) system schematic, when useful, to show protected system with multiple vessels;
- f) range of normal operating conditions, including pressure, temperature, level, fluid composition, and phase.

4.7.3.5 List of Overpressure Scenarios

Table 1 defines typical causes for overpressure. It is cautioned that Table 1 is not an exhaustive list of overpressure causes. The user should develop a checklist relevant to their processes and facilities. The user can apply Table 1 as an aid in developing a checklist. This checklist is a useful tool to ensure that all typical overpressure scenarios are considered.

For a specific system or equipment item, the relevancy of each scenario should be determined. If the cause is relevant, then the potential for overpressure should be evaluated and documented. If the cause is obviously not relevant, then no documentation would be required. For example, if the protected system does not have a heat exchanger, then the tube failure cause is not relevant and would not need further evaluation or documentation. If the cause is not obviously irrelevant then supporting documentation should be provided. For example, if there is a shell-and-tube heat exchanger but the design pressures on the shellside and tubeside systems are identical, then a tube failure case is not a cause for overpressure and this basis should be documented, but no further evaluations are necessary. If the tube failure would involve mixing of hot and volatile materials, then there is a potential for overpressure and further evaluations should be performed and documented.

There are some cases where the overpressure protection for a system or equipment item is managed by other methods or systems (e.g. instrumented protective systems) instead of a relief device. In such cases, supporting design documentation shall be provided.

Documenting overpressures scenarios in this way will enable those reviewing the documentation to understand the rationale used in the design process.

4.7.3.6 Relief Load Calculations

Each applicable overpressure scenario should have either a relief load calculation or an explanation describing why the calculation is unnecessary. For example, statements such as "Calculation not required since the liquid thermal expansion relief load will be smaller than the blocked discharge case" may be acceptable if detailed calculations are included for the blocked discharge scenario.

Common examples of information that may need to be provided often include, but are not limited to:

- a) relieving conditions, including pressure, temperature, fluid composition and phase;
- b) liquid levels, equipment elevations;
- c) control valve flow coefficients;
- d) credit for fire resistant insulation and/or drainage;
- e) pump impeller size used;
- f) heating or cooling duties;
- g) credit for locked, sealed, or normally open isolation valves;
- h) credit for operator intervention;
- i) credit for SIS/HIPS including SIL and associated reliability calculation.

4.7.3.7 PRD Documentation

A datasheet should be provided for each PRD (see 4.7.3.8 for vendor-supplied package units). The specification sheet provided in API 520, Part 1 could be used for this purpose.

Common examples of information that may need to be provided often include, but are not limited to, the following:

- a) applicable design code;
- b) specific revision of the relevant P&IDs;
- c) PRD type (e.g. conventional PRV, reverse-acting rupture disk);
- d) PRD make, model, inlet and outlet flange size and class, unique identifier (tag number);
- e) for PRVs, provide:
 - 1) set pressure and, where applicable, cold differential test pressure (CDTP);
 - 2) backpressure (constant and variable superimposed, built-up);
 - 3) required orifice area and selected orifice area;
 - 4) restricted lift design (if applicable);
 - 5) materials of construction.
- f) for rupture disks, provide:
 - 1) operating ratio;
 - 2) specified burst pressure and temperature;
 - 3) manufacturing design range;
 - 4) materials of construction;
 - 5) for rupture disks not installed in series with a PRV, provide the rupture disk coefficient of discharge (e.g. ASME KD) or the disk device resistance (e.g. ASME KR).

It is up to the user to define what is relevant for the specific PRD installation.

4.7.3.8 Relief Devices on Vendor-supplied Packaged Equipment

Packaged or skid-mounted equipment often includes relief devices. The vendor or user shall supply documentation for any relief devices that are included in that package. The user should establish requirements for this third-party supplied documentation. These requirements should include consideration of the potential hazards caused by overpressure. For example, the documentation requirements for a relief device protecting a low-pressure air blower might be different from those for a large refrigeration unit containing ammonia.

4.7.3.9 Installation Documentation

Common examples of information that may need to be provided often include, but are not limited to:

- a) discharge location (e.g. flare, closed system, atmosphere);
- b) list of isolation valves and administrative controls;
- c) inlet and outlet piping isometrics;
- d) inlet and outlet piping pressure drop calculations including supplemental PRV stability engineering analysis if performed;

NOTE Flare and vent header documentation requirements are in 4.8.

- e) piping stress analysis.

It is up to the user to define what is relevant for the specific PRD installation.

4.8 Flare Header Design Documentation

Common examples of information that may need to be provided often include, but are not limited to, the following.

- a) For each flare header scenario, a description of the initiating event and of the intermediate consequences that lead to relief flow. For example, for an electric power failure, this description would include the primary element assumed to fail, a list of all electric power users that would consequently be de-energized, and the consequences of the loss of each electric power user.
- b) Documentation of the basis used to define the flare system configuration for the network-flow simulation model. For the base case, this documentation generally consists of a list of piping drawings with revision numbers. For alternate piping configurations, changes from the base case may be marked on the schematic diagram of the system or described in narrative form.
- c) Schematic diagram of the flare system showing a pressure profile for each flare header scenario analyzed. The pressure profile should show calculated backpressure at each relief source discharging in the given scenario.
- d) Electronic copies of input files used for the network-flow simulation; electronic data files for the existing piping network should be provided.
- e) PRV size-selection datasheets showing valve manufacturer (for existing valves), type of valve, set pressure, size and inlet and outlet flange ratings.
- f) List of disposal system loads (e.g. loads from relief devices, depressuring valves, and control valves) including source name, temperature, relative molecular mass ("molecular weight") or composition, and flow rate.
- g) List of all credits taken to reduce or eliminate disposal system peak loads, including instrumentation (see 5.3.4 for details).
- h) List of instrumentation assumed not to work for each relieving scenario and basis for selection of failure combination.
- i) Backpressure limit for each source and basis for limit (e.g. downstream piping design pressure, see API 526^[6], manufacturer, critical flow, or derated valve capacity).
- j) Acceptance criteria for flare system capacity, including assumptions and design basis for the knockout drum and the flare stack.

4.9 Special Considerations for Individual PRDs

4.9.1 General

Sizing procedures for PRDs shall be in accordance with API 520, Part 1.

4.9.2 Liquid-Vapor Mixture and Solids Formation

A PRD handling a liquid at vapor-liquid equilibrium or a mixed-phase fluid produces vapor due to flashing as the fluid moves through the device. The vapor generation can reduce the effective mass flow capacity of the valve and should be taken into account. Liquid carryover can result from foaming or inadequate vapor-liquid disengaging. The designer is cautioned to investigate the effects of flow reduction or choking. Choking occurs at a point in any flowing compressible or flashing fluid where the available pressure drop increment is totally used up by accelerating the flashing fluid. Therefore, no additional pressure difference is available to overcome the friction in the incremental line length. See API 520, Part 1 and References [108], [110], and [155] for further discussion on this subject.

Some fluids (e.g. carbon dioxide and wet propane) can form solids when they are discharged through the relieving device. No uniformly accepted method has been established for reducing the possibility of plugging.

4.9.3 Location of a PRD in a Normally Liquid System

If valves or other devices are sized to relieve vapors caused by vapor entry or generation of vapor in a normally all-liquid system (see 4.4.8, 4.4.11, 4.4.13, and 4.6), care should be taken to locate the device so that it actually relieves vapor and is not required to relieve the volumetric equivalent of the vapor as liquid for an extended period. The consequences and effects of relieving an initial quantity of liquid through the relieving device should be considered.

4.9.4 Multiple PRDs

4.9.4.1 Basis

The pressure design code may limit the allowable range of set pressures for multiple PRDs. For example, see the more detailed information in ASME *BPVC*, Section VIII, Division 1, Paragraph UG-125 through Paragraph UG-140, Appendix 11 and Appendix M^[17].

4.9.4.2 Justification

The considerations that make a multiple PRV installation with staggered settings desirable include the following:

- a) sizing factor and valve leakage;
- b) pressure vessel requirements;
- c) inlet pressure characteristics of the PRV;
- d) reactive thrust at relief;
- e) range of required relieving rates for various contingencies.

In sizing PRVs, the designer should explore possible sources of overpressure, establish the governing flow rate, and select the required orifice area. Although the governing flow can result from a single factor or a combination of circumstances, the difficulty of anticipating simultaneous occurrences tends to encourage conservative sizing (oversizing). As the size of process units increases, the calculated area required often cannot be obtained in a single PRV body of rated, commercial design. Hence, multiple PRVs are needed simply to handle the required relieving rate. Minor fluctuations in the controlled vessel pressure can approach or enter the operating range of a single PRV. This creates continuous leakage that sustains itself until the pressure in the system drops low enough to enable the spring to force the valve closed. The larger the valve, the lower its lift to handle this small flow rate, and the greater the leakage at any given lift. Chatter and seat damage often accompany this circumstance. This problem is compounded with multiple PRVs uniformly set; however, multiple PRVs with staggered settings can provide a solution. If feasible, the lowest set valve should be the smallest one that can be selected on the basis of a reasonable relieving requirement or a reasonable portion of the total requirement. The higher set valves open only under conditions that require the combined orifice areas to handle the generated flow.

4.9.4.3 Application and Practice

See API 520, Part 1 and API 520, Part 2 for guidance.

The use of multiple PRVs can frequently be accomplished easily and economically if permitted by the pressure design code. In considering multiple PRV releases, the effects of backpressure should be evaluated with all valves releasing concurrently under that single contingency. The normal design approach is to consider that all PRVs are flowing simultaneously, whether they be staggered set valves on one vessel or several PRVs on various vessels that should also release under this same contingency. The aggregate rate of flow determines the backpressure in the system. Any increase in backpressure in the system that results from the contingency can be considered to be built-up backpressure. Where conventional PRVs are employed, there are backpressure limits that shall be considered. Within these limitations, it is not necessary to consider the changes in backpressure caused by flow that result from one valve opening before another as superimposed backpressure on other valves.

5 Disposal Systems

5.1 General

The selection of a disposal method is subject to many factors that can be specific to a particular location or an individual unit. The purpose of a disposal system is to conduct the relieved fluid to a location where it can be safely discharged. Disposal systems generally consist of piping and vessels. All components should be suitable in size, pressure rating, and material for the service conditions intended. Section 5 outlines the general principles and design approach for determining the most suitable type of disposal system.

5.2 Fluid Properties That Influence Selection and Design of Disposal Systems

5.2.1 Physical, Chemical, and Reactive Properties

The flash point, flammable limits, and ignition temperatures of certain flammable liquids, gases, and solids are listed in NFPA HAZ01^[128]. Additional data on the flammability characteristics of pure compounds and mixtures, in both air and atmospheres that contain varying amounts of inert gases and water vapor, are found in the United States Bureau of Mines Bulletin 627^[167]. This reference also provides information on explosive limits and presents a method for calculating the flammability characteristics of mixtures, based on the properties of pure compounds.

Consideration should be given to any phase change, either vaporization of liquid or condensation of vapor, that occurs in the fluid when the pressure is reduced or as a result of cooling. With autorefrigeration, vaporization of volatile liquids can be incomplete unless facilities are provided to add the necessary heat for vaporization.

Caution should be exercised to avoid mixing chemicals that can react in headers and drums. Routing reactive materials to a header or drum has caused high pressures that have resulted in ruptures. Materials that react violently when mixed with water (such as alkyls, sodium, potassium, and silanes) should be routed to a segregated header that does not contain water.

Caution should be exercised to avoid mixing of water with other sources if there is a potential for solids formation in the flare system. If there is a potential for formation of ice or hydrates, the water sources should be routed in a separate header to the flare knockout drum.

Caution should be exercised to avoid mixing volatile liquids and hot liquids in the flare system (see 4.4.6).

Some compounds (e.g. ethylene oxide) have such high reactivity and flammability that flaring poses more hazards than benefits. Other options shall be considered for these compounds such as scrubbers, etc.

See also 5.4.3.

5.2.2 Temperature

5.2.2.1 General

Only a comprehensive study of the plot plan and individual PRD data can determine the most desirable system for a particular plant. The methods of coping with temperature problems given in 5.2.2.2 through 5.2.2.4 are not meant to be limiting. They are included merely to illustrate a principle of separation of discharges.

5.2.2.2 Ambient Temperature

Nonvolatile liquids at ambient temperatures may be discharged into a separate, closed relief header that discharges into a sump from which the liquids are recovered. Volatile or nonvolatile liquids may be alternately discharged into the regular, closed disposal system capable of containing the pressure. The liquid is disengaged at the knockout drum before the flare (see 5.7.8 for additional details).

5.2.2.3 High Temperature

Hot liquids and vapor may be cooled and condensed by one of the methods covered in 5.2.2.3 a) through 5.2.2.3 c).

- a) PRDs that discharge hot condensable hydrocarbon vapors or liquids may be piped into a separate header that terminates in a quench drum. In this service, quenching can reduce the temperature of the relief stream and may permit the use of less expensive materials in downstream equipment. Cooling also condenses some of the less volatile components and can reduce or prevent the release of hot condensable vapors to the atmosphere. A quench drum is a vessel equipped to spray a quenching liquid down through the hot discharged gases as they pass at reduced velocity through the drum. The quenching fluid may be water, gas oil, or another suitable liquid. The quenching liquid collects in the bottom of the drum for subsequent removal.

One type of quench drum is a vertical vessel containing baffles that is connected by a means of a conical transition to a vent stack or flare. The condensable hydrocarbon material is fed into the drum below the baffles. Water is introduced into the drum above the baffles at a rate that depends on the temperature and the amount of hydrocarbon material being fed to the quench drum. The water spilling over the baffles desuperheats and condenses the hydrocarbon vapor, knocks out entrained hydrocarbon liquid, and cools down the hydrocarbon liquid collected in the bottom of the drum. The uncondensed vapor and any steam formed pass up the vent stack or enter a flare system (see Figure D.2 and Figure D.3).

Sizing of the quench drum is discussed in 5.8.7.3. In addition to the quenching of vapors, the drum is typically required to provide vapor-liquid separation, liquid retention, and disposal. If the quench drum is part of a header network consisting of multiple relief devices or tie-ins, then see 5.4.3, 5.8.8, and 5.8.10 for additional design guidance.

- b) The submerged discharge system is not extensively used in present day design. Care should be taken in its use and location when noncondensable gases that can escape to the atmosphere are present. Cooling of hot liquid and condensation of vapor by submerged discharge in a large body of cold liquid can have limited utility when considered as a disposal method to a lower-pressure system in the same process unit. Occasionally, steam is mixed with the effluent in sufficiently large quantities to make the discharge noncombustible. In this type of design, the pressure-relieving system on a unit that handles heavy hydrocarbons generally serves a dual purpose—as a disposal system for the PRDs and as a knockout system for furnaces and vessels.

The submerged discharge system is a relieving system that terminates in parallel laterals submerged in a water-filled sump. Holes are cut in the bottom of the laterals throughout their length, imparting downward flow to the discharged effluent to obtain maximum agitation, cooling, and condensing. Provisions shall be made to maintain a liquid level in the sump while the system is being used. The discharge is drained from this sump into a separator, where the oil and condensed vapors are removed from the water.

- c) The use of shell-and-tube heat exchangers or coil-in-box coolers has the merit of separating cooled or condensed material immediately. In addition, the coil-in-box (emergency box cooler) cooler can remove some heat in emergencies when no cooling water is flowing.

5.2.2.4 Low Temperature

Low-temperature fluids require considerations similar to those outlined for hot streams, particularly if there is a possibility of low-boiling point liquids entering the disposal system. Autorefrigeration will occur as liquid boils at the reduced pressure. If the equilibrium temperature is sufficiently low, piping and drums fabricated of materials designed for low temperature may be required to eliminate the risk of brittle fracture^[9]. In such circumstances, consideration should be given either to a completely separate low-temperature system or isolation of the stream until it reaches a knockout drum where the liquid can disengage. Vapors vented off the drum can often be safely combined with other disposal systems if, in the absence of liquid, the heat pickup (of the piping system) from the surrounding atmosphere will prevent temperatures from dropping to a dangerously low level.

5.2.3 Hazardous and Nuisance Properties

The safe disposal of material that has toxic, acidic, alkaline, or corrosive properties may require chemical neutralization, absorption, or reaction in a special disposal system. Dilution with air or water to a safe level may be satisfactory in some cases.

The physiological and nuisance properties of material released from pressure-relieving and depressuring systems should be studied to establish the proper type of disposal system.

5.2.4 Viscosity and Solidification

In the selection of a disposal system for liquids and condensable vapors, the production of highly viscous or solid materials warrants consideration. The design of a disposal system for such materials may require heat tracing of valves and discharge lines. The formation of gums, polymers, coke, or ice that might prevent safe operation of the discharge system should also be considered in the design.

5.2.5 Miscibility

Solubility or miscibility of the material with water and avoidance of the formation of emulsions should be considered in the selection of a disposal system.

5.2.6 Recovery Value

The monetary value of process wastes can warrant special means of collection for return to the process, as is the case, for example, of costly solvents. An economic-engineering evaluation can determine whether the recovery value of the material justifies the installation of a recovery system. If a recovery system is justified, or required by local regulations, see 5.7.10 for guidance. To avoid loss of valuable process material, the PRD should be set sufficiently above the normal operating pressure to give a reliable margin of differential pressure.

5.3 System Design Load

5.3.1 General

The entire process of developing disposal system design loads can be a complex process requiring input from process, operations, instrumentation, and other engineering disciplines. The disposal system boundary includes the piping, vessels, and other equipment from the PRD outlet to the final disposal point. Sizing of the disposal system can impact the PRD operation (e.g. backpressure on PRVs, derating, etc.).

Although required relieving rates from individual devices for single jeopardy events are known, it is necessary to determine the combined effects on the disposal system, for example:

- a) loss of cooling water and/or instrument air compressor as a result of loss of power;
- b) loss of process reboil heat from a downstream column;
- c) loss of instrument air might not cause loss of power; however, loss of power can directly cause loss of instrument air (e.g. loss of power to air compressor);
- d) instrumentation impacts (favorable or unfavorable) can require complex analysis;
- e) load reduction credits.

The following are general steps in establishing disposal system design loads.

- a) As a starting point, establish the required relieving loads for the contingencies described in Section 4 for each individual relief device discharging into the disposal system. Consider the potential disposal system loads from pressure control valves or emergency depressuring valves.
- b) Determine which pressure systems are jointly affected by single contingencies (see 5.3.2).
- c) Establish the maximum load into the disposal system during these contingencies (see 5.3.3).
- d) Establish the design load for the disposal system (see 5.3.4).

5.3.2 Loads from Pressure Systems

The contingencies to be considered in defining relieving requirements are discussed in Section 4. To define the system load, it is not necessary to assume the simultaneous occurrence of two or more unrelated contingencies. For example, an inadvertently closed valve at the same time a utility failure occurs is not typically considered. Therefore, the analysis should focus on individual initiating events and the resultant effects.

Particular study is required for cases of failure of major utilities, such as power or cooling medium. Partial failure and total failure of electrical power, steam, cooling medium, heating medium, and instrument air to an entire plant should be considered. There are cases where partial failures result in higher loads than total failures. This type of study, with reference to electrical power failure, commonly results in a design based on the failure of one bus, although loss of an entire distribution center or of the incoming line can govern the design.

Interaction of utilities should also be considered. For example, loss of power can lead to loss of instrument air, steam, heating medium, and/or cooling medium. The most common basis for analyzing cooling-medium or heating-medium failure is the failure of the entire supply. Instrument air failure is commonly considered to be a plant-wide failure unless conditions exist that allow the air supply to continue, such as when automatic makeup from an uninterrupted source or when multiple-compressor-source supplies are provided. Failure of the plant power to electronic or electrical instruments may also be considered, although credit can be given for sufficiently reliable backup power supplies (e.g. uninterruptible power supply).

To define the combined relieving loads under fire exposure, the probable maximum extent of a fire should be estimated. As a conservative approach, in the absence of any other governing factors, consideration of a fire-impact area is frequently limited to a ground area of 230 m² to 460 m² (2500 ft² to 5000 ft²). A more detailed analysis can show a smaller fire-impact area. This detailed analysis includes consideration of the actual layout of facilities, the location of sources of combustibles, the provision of drainage and the effects of natural barriers.

Facilities that handle only flammable gases can be assumed to generate more localized fires than those produced when the release of flammable or combustible liquids results in a pool fire.

5.3.3 Establishing Design Load for the Disposal System

The maximum potential load should be calculated for each common-mode event by adding up the individual system loads that would result during that contingency. For a common-mode event, it is necessary for the designer to determine the loads for each individual system including, as applicable, PRDs, emergency depressuring valves, and/or other control valves (e.g. pressure control vent valves). It is important to recognize that systems with pressure control valves and/or depressuring valves can maintain the pressure below the set pressure of a PRD. In such cases, it is not necessary to include the load from the PRD in the flare load in addition to that from the pressure control valves and/or depressuring valves. Note that in these cases the resulting disposal system load from the pressure control valve or the emergency depressuring valve can be larger than the calculated load for the PRD. For example, reboiler temperature pinch at full relieving pressure results in no relief load but the pressure control vent valve opens at a pressure where the reboiler can still generate a vapor load to the disposal system.

The maximum flow through an emergency depressuring valve or pressure control valve is limited by the maximum expected pressure upstream of the valve at the moment it is first opened. The designer shall determine this maximum expected pressure by reviewing the scenarios in which the emergency depressuring valve or pressure control valve is opened. If the scenario involves vessels reaching PRD set pressure or full relieving pressure prior to opening the emergency depressuring valve or pressure control valve, then these pressures should be used as the

design basis. If the scenario is such that no abnormal pressure buildup is expected prior to opening the emergency depressuring valve or pressure control valve, then the maximum normal operating pressure can be used as the design basis. It is important to recognize that reclosable PRDs might not have an additive load contribution to pressure control valves connected to the same vessel or equipment.

If the capacity of a vapor depressuring valve exceeds the normal vapor flow rate within the protected equipment or if the depressuring rate is additive to normal flows within the equipment, considerable liquid entrainment can occur. Therefore, disposal systems for depressuring valves should generally provide for liquid carryover.

The disposal system design basis is not necessarily based on the maximum mass load, because of the influence of fluid properties. For example, the flow that imposes the greatest head loss in flowing through the system might not be the highest mass flow. Thus, a flow of 12.6 kg/s (100,000 lb/h) of a vapor with a relative molecular mass of 19 at a temperature of 149 °C (300 °F) develops a greater head loss and is a greater “load” than a flow at 18.9 kg/s (150,000 lb/h) of a vapor with a relative molecular mass of 44 at a temperature of 38 °C (100 °F). Also, different scenarios may set the design basis for individual components such as laterals, knockout drums, flare stack, etc.

5.3.4 Refinement of the Disposal System Design Load

5.3.4.1 General

There are several techniques that can be applied to establish a disposal system design load that is less than the maximum as calculated in 5.3.3. The use of the techniques described in 5.3.4.2 and 5.3.4.3, particularly in combination, requires detailed analysis and can be very complex.

5.3.4.2 Dynamic System Load Modeling

Dynamic system load modeling allows the user to predict the timing of individual system peak loads to determine the disposal system hydraulic performance. Various time intervals should be considered, as a peak load for various parts of the disposal system can occur at different times. Dynamic system load modeling differs from individual system dynamic modeling (as described in 4.3.3) because the former considers the timing of multiple reliefs, whereas the latter is focusing on determining only the peak load from one system without regard to the effect of timing on other relief loads. During a common mode event (fire or major utility failure) not all affected pressure systems reach full relieving conditions at the same time, and not all affected systems are able to sustain their loads for the same duration. Dynamic system load modeling can require more sensitivity studies than individual system dynamic modeling because the combined peak load for the disposal system might not necessarily occur during the peak load of an individual pressure system.

5.3.4.3 Load Reduction Credits

Load reduction credits include HIPS (see Annex E), operator intervention, basic process control, etc. As stated in 4.2.6, credit for some favorable instrumentation response to reduce disposal system design loads may be taken. The decision to exclude a particular load due to the favorable response of instrument systems should consider the number and reliability of applicable instrument systems. SISs with high SIL values (see 3.1.69 and 3.1.70) are more likely to function than simple instrument trip systems or basic process control instrumentation. One approach is for the user to determine, based on instrument system reliability, the percentage of these systems that would not function as designed. After doing so, the user then determines which instrument system is assumed to fail. Typically, the instrument systems that contribute the highest loads and/or backpressures are assumed to fail. When following this approach, the user should assess the potential for failure of multiple instrument systems affecting common relief headers to assure an adequate design.

Consideration may also be given to the capability for and response time available for operator intervention as a means of reducing system loads. When doing so, the user shall consider what other demands can be placed on the operator during the upset. Operator intervention credits may have already been taken in establishing the individual system relief load (see 4.2.5) and major upsets can require the operator to respond to many alarm conditions.

The basis for taking system-relief load-reduction credits should be evaluated carefully to ensure an adequate design. One method of assessing the acceptability of system-relief load-reduction credits is to quantitatively assess the disposal system performance as a whole. This method considers the likelihood of the overpressure

contingencies and the reliability of the safeguards that reduce or eliminate individual relief loads. This quantitative approach calculates the probabilistic disposal system loads, probabilistic hydraulics, and probabilistic equipment overpressures. The system performance is compared to the user's acceptance criteria.

5.4 System Arrangement

5.4.1 General

Once the various combinations of loads have been defined for all pertinent contingencies and the corresponding allowable backpressures have been determined for all PRDs, selection of the disposal system can proceed. The factors influencing the choice of the disposal system are discussed in 5.2 and 5.6 through 5.8.

In selecting the arrangement of the disposal system or systems, special attention should be given to situations where PRDs can discharge flashing liquids or where a combination of cold liquid and hot vapor discharge can result in vaporization of the liquid. Such situations can generate additional vapor loads beyond those that correspond to the relieving loads (see also 5.2.2.4 for special considerations in handling liquids that are capable of autorefrigeration).

Table 8 can be used to determine where the required relieving rate and PRD rated capacity should be used in design of laterals and main header (if applicable).

Table 8—Design Basis for PRD Laterals and Disposal System Headers

Device	Lateral/Tail Pipe	Main Header (If Applicable)
Pop-action, pilot-operated PRV	PRV rated capacity	Required relieving rate
Modulating-action, pilot-operated PRV	Required relieving rate	Required relieving rate
Spring-loaded PRV	PRV rated capacity	Required relieving rate
Rupture disk (stand-alone)	Required relieving rate	Required relieving rate
Pin-actuated device (stand-alone)	Required relieving rate	Required relieving rate
NOTE 1 Consult the manufacturer, as some types of spring-loaded PRVs can have some modulating capability. In these instances, the required relieving rate may be used.		
NOTE 2 The mechanical and hydraulic design of the system should consider that the instantaneous flow rate upon opening can exceed the required relieving rate, particularly in cases where the relief device is oversized.		
NOTE 3 The user is cautioned that if the required relieving rate is used for design of the lateral (see 3.1.38), any process changes that raise the required relieving rate can increase the backpressure above the acceptable limits.		

5.4.2 Single-device Disposal Systems

Where only a single PRD or a single depressuring valve is connected to the disposal system, the outlet may also be to the atmosphere, to another system operating at lower pressure or to a local flare.

If the outlet is connected to a lower-pressure system, the allowable pressure drop in the disposal system should generally be based on the MAWP of the lower-pressure equipment. However, a reduced backpressure (e.g. normal operating pressure in the lower-pressure equipment) may be used if it can be shown that:

- none of the contingencies causing a relieving load also overpressure the lower-pressure equipment, and
- the load (the required relieving rate of the device) imposed by the higher-pressure relief device does not result in overpressuring the lower-pressure equipment.

Each PRD that vents directly to the atmosphere should normally have an individual vent pipe sized for a relatively high exit velocity; however, the outlet piping should not be smaller than the PRD outlet. The developed backpressure of this system should include all pressure losses, such as friction losses and kinetic energy loss.

Pop-action PRVs normally have the backpressure calculation based on the rated capacity of the valve. The design of the disposal system should be checked for adequacy under such conditions. Modulating pilot-operated-type PRVs generate loads that are equivalent to the required relieving rate for a particular contingency^[39]. The initial design of the disposal system should, as a minimum, be based upon this required relieving rate.

Typically, the required relieving rate is used for the flare header, flare tip, and knockout drum design with spring-loaded PRVs. However, there can be instances where a higher flow rate than required can be encountered that affects operation of the downstream equipment. For example, most spring-loaded PRVs discharge 50 % or more of their rated capacity at set pressure. Consequently, the initial flow rate can be greater than the required relieving rate. In this case, the rated capacity can be used as an upper-limit flow rate when designing downstream components such as scrubbers, thermal oxidizers, and liquid seal drums.

Some spring-loaded PRVs have limited modulating capabilities and can initially vent at rated capacity; consult the manufacturer to determine if the valve has modulating characteristics.

For rupture disk or pin-actuated devices installed as a stand-alone device (i.e. not upstream of a PRV), the required relieving rate is typically used to size the piping and the relief device. The design of downstream equipment, particularly scrubbers and thermal oxidizers, should consider the higher load that can be encountered based on the upstream pressure at which the relief device opens. The piping mechanical design should also consider this higher initial capacity.

5.4.3 Multiple-device Disposal System

For disposal to a flare or to a remote atmospheric vent stack, combining the discharges from a number of PRDs or depressuring valves is usually economical. The specific arrangement of the headers and the routing of piping for the multiple-device system is normally a question of minimizing investment. This requires taking into consideration the system loads, the backpressure limitations, the requirement for special materials, and other design parameters discussed in 5.4.1 and 5.4.2. If discharging to atmosphere, see the cautions and additional requirements in 5.8 and, in particular, 5.8.7 and 5.8.8 if there is a potential for liquid relief.

In defining the header arrangements, consideration should be given to any requirements for separate shutdowns or separate maintenance on the protected equipment. It is usually not advisable to route PRD headers from one operating area through another area where major maintenance shutdowns are performed separately. Furthermore, it is usually advisable to be able to isolate headers that serve separate process areas from the disposal system, rather than to be required to isolate individual PRDs within a common process area.

Multiple PRD disposal systems that handle combustible vapors should not be used for venting air or steam during the start-up of process equipment. Any tie-ins of process vents to the multiple-device system should be accompanied by strict instructions against using such tie-ins for venting air to avoid flammable mixtures in a system.

Most multiple-device systems involve collecting PRD discharges from various elevations. In general, laterals and headers should be arranged so that the outlet from each PRD is not a liquid trap. All collecting piping should be considered subject to the inflow of liquid and should avoid liquid traps. If it is not practical to arrange the piping so that laterals and headers drain to a remote knockout drum, a local knockout drum is usually required. It is normally not necessary for this local knockout drum to be sized for efficient vapor-liquid separation at the maximum flow rate but only for collecting the probable maximum liquid carryover from any devices that can discharge liquids. The use of traps or other devices with operating mechanisms should be avoided.

If the liquids to be handled include water or oil with a relatively high pour point, a provision should be made to avoid solidification in the system. Likewise, the introduction of high-viscosity liquids can require protection against low ambient temperature, particularly on instrument impulse lines.

5.4.4 Header Segregation

Disposal system design should assess the requirement to segregate streams on the basis of pressure, temperature, and fluid composition/physical properties. Where segregation of streams is required, consideration should be given to segregating both the headers and the knockout drums if interactions between connected headers could impair the disposal system's functionality.

Consideration should be given to segregating the relief flows from high- and low-pressure sources to maintain backpressures on PRDs within allowable limits.

When considering the allocation of sources to relief headers the potential for the following should be taken into account:

- a) presence of corrosive materials;
- b) toxic materials (e.g. H₂S, benzene);
- c) ice and/or hydrate formation;
- d) freezing heavy hydrocarbons or solid deposition (e.g. wax);
- e) formation of H₂S hydrates or solid CO₂;
- f) condensation of hot sources when mixed with cold sources which could result in air ingress into the relief system;
- g) rapid vaporization of liquids when contacted with hot sources;
- h) reactive materials (see 5.2.1).

Water-wet fluids should be segregated from cold fluids to prevent ice/hydrate formation. Additional measures should be assessed for high-pressure sources that contain water due to the potential for phase changes due to autorefrigeration (i.e. high-pressure wet stream that cools to below its ice formation or hydrate temperature when relieved to the relief header). Consideration should be given to altering the stream conditions to prevent ice/hydrate formation or to providing chemical inhibition (e.g. methanol injection). These streams could also be segregated from other headers and routed directly to the knockout drum such that a blockage would not impair the functionality of any other connected system.

Caution should be exercised when routing sources containing significant quantities of free liquids to a header. If this cannot be avoided then the system should be designed to accommodate the potential for accumulated liquids (e.g. slug flow in the header and/or providing adequate liquid knockout facilities).

When designing the relief discharges from rupture disks protecting the low-pressure side of heat exchange equipment, the following should be considered:

- a) allocation to the appropriate relief system on the basis of the relieving fluid conditions;
- b) segregation of the relief collection header directly connected to the knockout drum or a local liquid knockout vessel to prevent reverse flow from the relief collection header into the low-pressure system;
- c) designing for slug flow.

Lower-pressure sources should not be routed to a high-pressure disposal system if there is a risk of reverse flow (potentially caused by high backpressure due to blockage) into the lower-pressure system. Design should ensure that segregation is adequate or if segregation is not possible that sufficient mitigation is in place on the lower-pressure system to limit the consequences of reverse flow.

It is preferred to segregate the relief knockout drum from the drum used to collect nonrelief liquid flows. A separate drum allows improved traceability of a liquid source in the event that a drain valve has been inadvertently opened.

5.5 Piping

5.5.1 General

The design of disposal piping should comply with ASME B31.3 ^[18] or other piping codes specified by the user.

Installation details and criteria pertinent to PRDs should conform to those specified in API 520, Part 2.

5.5.2 Backpressure

The basic criterion for sizing the discharge piping and the relief manifold is that the backpressure (which can exist or be developed at any point in the system) shall not reduce the relieving capacity of any of the PRDs below the amount required to protect the corresponding vessels from overpressure. Thus, the effect of superimposed or built-up backpressure on the operating characteristics of the valves should be carefully examined. The discharge piping system should be designed so that the built-up backpressure caused by the flow through the valve under consideration does not reduce the capacity below that required of any PRV that can be relieving simultaneously. Where conventional PRVs are used, the relief manifold system should be sized to limit the built-up backpressure to that allowed by API 520, Part 1. Additionally, the effect of superimposed backpressure from other valves upon the set pressure should be considered.

With balanced PRVs (bellows, piston, or pilot operated), higher manifold pressures can be used. The capacity of these balanced PRVs begins to decrease when the backpressure exceeds 30 % to 50 % of the set pressure due to subsonic flow and/or physical responses to the high backpressure. See API 520, Part 1 and/or manufacturer's curves for the effects of this backpressure. Additionally, the backpressure should not exceed the rating tabulated in API 526 ^[6] as specified by the user, which can be lower than the outlet flange rating.

When discharge manifolds and relief headers are sized, the relief contingency that produces the greatest backpressure should be identified. Any single relief contingency may involve several PRDs. Typical relief contingencies that may be considered include cooling water failure, power failure, and instrument air failure.

5.5.3 Line Sizing

In addition to the backpressure criterion, the determination of the flow rate to be considered forms the basis for discharge line sizing. In general, laterals and tail pipes from individual PRVs are sized based on the rated capacity (see Table 8). The lateral or tail pipe from a modulating pilot-operated PRV is sized based upon the required relieving rate for a particular contingency. If process conditions change and the required relieving rate is higher than the initial design, the lateral or tail pipe from the modulating pilot-operated PRV should be checked for adequacy.

If the user has established a velocity criterion for tail pipes, the maximum velocity in a tail pipe should be calculated with the single source (the relief or depressurization device) as the only source discharging into the disposal system. Due to pressure drop in the tail pipe, the maximum velocity should be calculated at the end of each pipe diameter (if the diameter varies). Common header systems and manifolds in multiple-device installations are generally sized based on the worst-case cumulative required capacities (instead of rated capacities) of all devices that can reasonably be expected to discharge simultaneously in a single overpressure event (in other words, for certain scenarios, it can be appropriate to assume some level of favorable instrument and/or operation response). See API 520, Part 1 for information regarding rated capacities. Causes and required relieving capacities of overpressure events are discussed in 4.4. If process conditions change and dictate a higher required cumulative capacity from the initial design, the common header system should be reevaluated.

Simple rules cannot be expected to cover all installations. Good engineering judgment should be applied to select the flow basis most appropriate to each case.

In designing vapor depressuring systems, precise pressure drop calculations are usually not necessary. The only limits on built-up backpressure, in addition to those mentioned above, are as follows.

- a) The ratings of fittings exposed to backpressure should not be exceeded.
- b) Any source that can reasonably be depressurized concurrently should be capable of entering the header when its depressuring valve is opened.
- c) Reverse flow from the header into any connected process should be avoided.

When the maximum vapor-relieving requirement has been established and the maximum allowable header backpressure has been defined (as determined by the type of valves in the system and the applicable design requirements), the selection of line size is then reduced to fluid-flow calculations. Several methods can be used to calculate the size of discharge piping when the flow conditions are known. These range from treating the flow as isothermal, with appropriate allowances for kinetic energy effects, to the more rigorous solutions afforded by the adiabatic approach. A number of methods listed in Bibliography under the heading "Piping" permit the user to select the method best suited to their needs. In the absence of any preference, the methods in 5.5.5 through 5.5.10 are recommended.

5.5.4 Multiple-relief Scenarios

Several commercial relief system network-flow simulation programs are available to the designer. The programs allow the user to model a complex flare system, including PRD inlet piping, PRDs, pressure vents, outlet tail piping, flare laterals, main flare header, knockout drum, seal drum, flare stack, and flare tip. Hydraulic capacity of modern flare tips is not directly discernible from the mounting flange size alone. Consult the flare vendor for flare tip capacity. See API 537 for more details. Multiple-relief scenarios can be studied by alternating the devices that are allowed to flow. The programs typically use a steady-state equation of state to predict the properties of the fluid in the relief system. For gases or vapors, both isothermal and adiabatic flow models are usually available. Additionally, there are options to consider heat transfer (i.e. conditions between adiabatic and isothermal). Discontinuities in pressure, for gases, vapors, and two-phase fluid, due to critical-flow conditions at restrictions such as the PRD outlet and the tail pipe outlets shall be taken into account by the program. For two-phase flow conditions, typically a two-phase pressure drop method, such as Brill and Beggs^[35] or the homogeneous equilibrium method (see 5.5.10) may be used. The Brill and Beggs method should have an adjustment in the acceleration term where necessary, due to the high velocity frequently found in flare headers. Critical flow conditions are typically handled by assuming homogeneous flow and applying basic thermodynamic relationships.

For less complex systems handling gases or vapors, spreadsheet models or other user-developed models can be employed to size and verify the relief system. A typical model of this type uses mass flow, density, and heat capacity relationships to calculate the flow, temperature, and physical properties of the relief fluid at nodes in the system. The pressure at various points is calculated using a compressible flow model (either isothermal or adiabatic). It is important that the model also check for pressure discontinuities due to critical flow in the system. Various relief scenarios can be evaluated by changing which inputs are active.

5.5.5 Isothermal Pressure Drop Calculation Method

A number of methods listed in Bibliography under the heading "Piping" permit the user to select a manual method to calculate the backpressure for gases and vapor in flare systems. In the absence of any preference, the methods described in the remainder of this section are suggested.

Vapor flow in relief discharge piping is characterized by rapid changes in density and velocity; consequently, the flow should be rated as compressible. Several methods for calculating the size of discharge piping have been developed using isothermal or adiabatic flow equations. Actual flow conditions in relief systems are normally somewhere between isothermal and adiabatic conditions. For most cases, the slightly more conservative isothermal equations are recommended; however, the adiabatic flow equations can be preferable for some less-common applications (e.g. cryogenic conditions).

The sizing of relief discharge piping can usually be simplified by starting at the system outlet, where the pressure is known, and working back through the system to verify acceptable backpressure at each PRD. Calculations are performed in a stepwise manner for each pipe segment of constant diameter. The isothermal flow equation based on inlet Mach number^[113] is as given in Equation (32):

$$\frac{f \times l}{d} = \frac{1}{Ma_1^2} \left[1 - \left(\frac{p_2}{p_1} \right)^2 \right] - \ln \left(\frac{p_1}{p_2} \right)^2 \quad (32)$$

The equation can be transposed to Equation (33) for outlet Mach number:

$$\frac{f \times l}{d} = \frac{1}{Ma_2^2} \left[\left(\frac{p_1}{p_2} \right)^2 \right] \left[1 - \left(\frac{p_2}{p_1} \right)^2 \right] - \ln \left(\frac{p_1}{p_2} \right)^2 \quad (33)$$

where

- f is the Moody friction factor, dimensionless;
- l is the equivalent length of pipe, expressed in m (ft);
- d is the pipe inside diameter, expressed in m (ft);
- Ma_1 is the Mach number at pipe inlet, dimensionless;
- Ma_2 is the Mach number at pipe outlet, dimensionless;
- p_1 is the pipe inlet absolute pressure, expressed in kPa (psi);
- p_2 is the pipe outlet absolute pressure, expressed in kPa (psi).

The isothermal outlet Mach number is given by Equation (34) and Equation (35):

In SI units:

$$Ma_2 = 3.23 \times 10^{-5} \left(\frac{q_m}{p_2 \times d^2} \right) \left(\frac{Z \times T}{M} \right)^{0.5} \quad (34)$$

In USC units:

$$Ma_2 = 1.702 \times 10^{-5} \left(\frac{q_m}{p_2 \times d^2} \right) \left(\frac{Z \times T}{M} \right)^{0.5} \quad (35)$$

where

- q_m is the gas mass flow rate, expressed in kg/h (lb/h);
- Z is the gas compressibility factor, dimensionless;
- T is the absolute temperature, expressed in K (°R);
- M is the gas relative molecular mass.

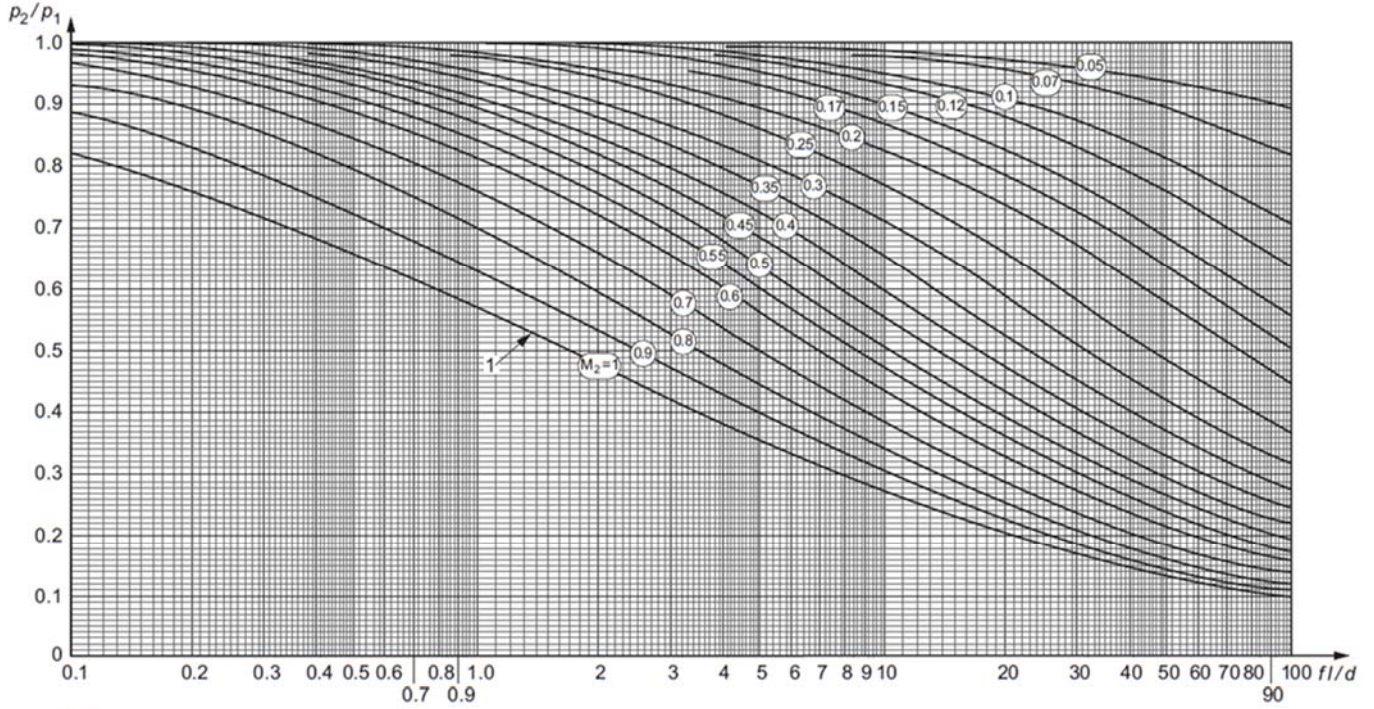

Key
 1 critical flow line

NOTE This figure is reprinted with permission from the *Oil and Gas Journal*, Nov. 20, 1978, p. 166.

Figure 3—Isothermal Flow Chart

Both graphical and computerized methods have been developed for solving Equation (32) and Equation (33) and calculating pipe inlet pressure [96, 113]. Figure 3 is a typical graphical representation of Equation (32). The figure may be used to calculate the inlet pressure, p_1 , for a line segment of constant diameter where the outlet pressure is known. If the relief system is to be operated at high pressure, the flow may be sonic in some parts of the system. In those cases, a check should be made to see if the flow is critical. The critical pressure at the pipe outlet can be determined by setting $Ma_2 = 1.0$ (sonic flow) in Equation (34) and Equation (35), resulting in Equation (36) and Equation (37).

In SI units:

$$p_{crit} = 3.23 \times 10^{-5} \left(\frac{q_m}{d^2} \right) \left(\frac{Z \times T}{M} \right)^{0.5} \tag{36}$$

In USC units:

$$p_{crit} = 1.702 \times 10^{-5} \left(\frac{q_m}{d^2} \right) \left(\frac{Z \times T}{M} \right)^{0.5} \tag{37}$$

where

p_{crit} is the critical absolute pressure, expressed in kPa (psi).

If the critical pressure is less than the pipe outlet pressure, the flow is subsonic. If the critical pressure is greater than the pipe outlet pressure, the flow is sonic and $Ma_2 = 1$. Therefore, the pipe inlet pressure, p_1 , is calculated from Equation (33) with p_2 equal to the critical pressure.

5.5.6 Lapple Pressure Drop Calculation Method

A rapid solution for sizing depressuring lines is offered in the remainder of this section, using the method developed by Lapple ^[103]. This method employs a theoretical critical mass flow based on an ideal nozzle and adiabatic flow conditions and assumes a known upstream low-velocity source pressure. The critical mass flux for isothermal flow conditions (i.e. where vapor $k = C_p/C_v = 1.00$) can be determined using Equation (38) and Equation (39):

In SI units:

$$G_{Ci} = 6.7 p_1 \left(\frac{M}{Z \times T_1} \right)^{0.5} \quad (38)$$

In USC units:

$$G_{Ci} = 12.6 p_1 \left(\frac{M}{Z \times T_1} \right)^{0.5} \quad (39)$$

where

G_{Ci} is the critical mass flux, expressed in kg/s·m² (lb/s·ft²);

p_1 is the absolute pressure at the upstream low-velocity source (see Figure 4), expressed in kPa (psi);

M is the relative molecular mass of the vapor;

T_1 is the upstream temperature, expressed in K(°R);

Z is the compressibility factor, dimensionless.

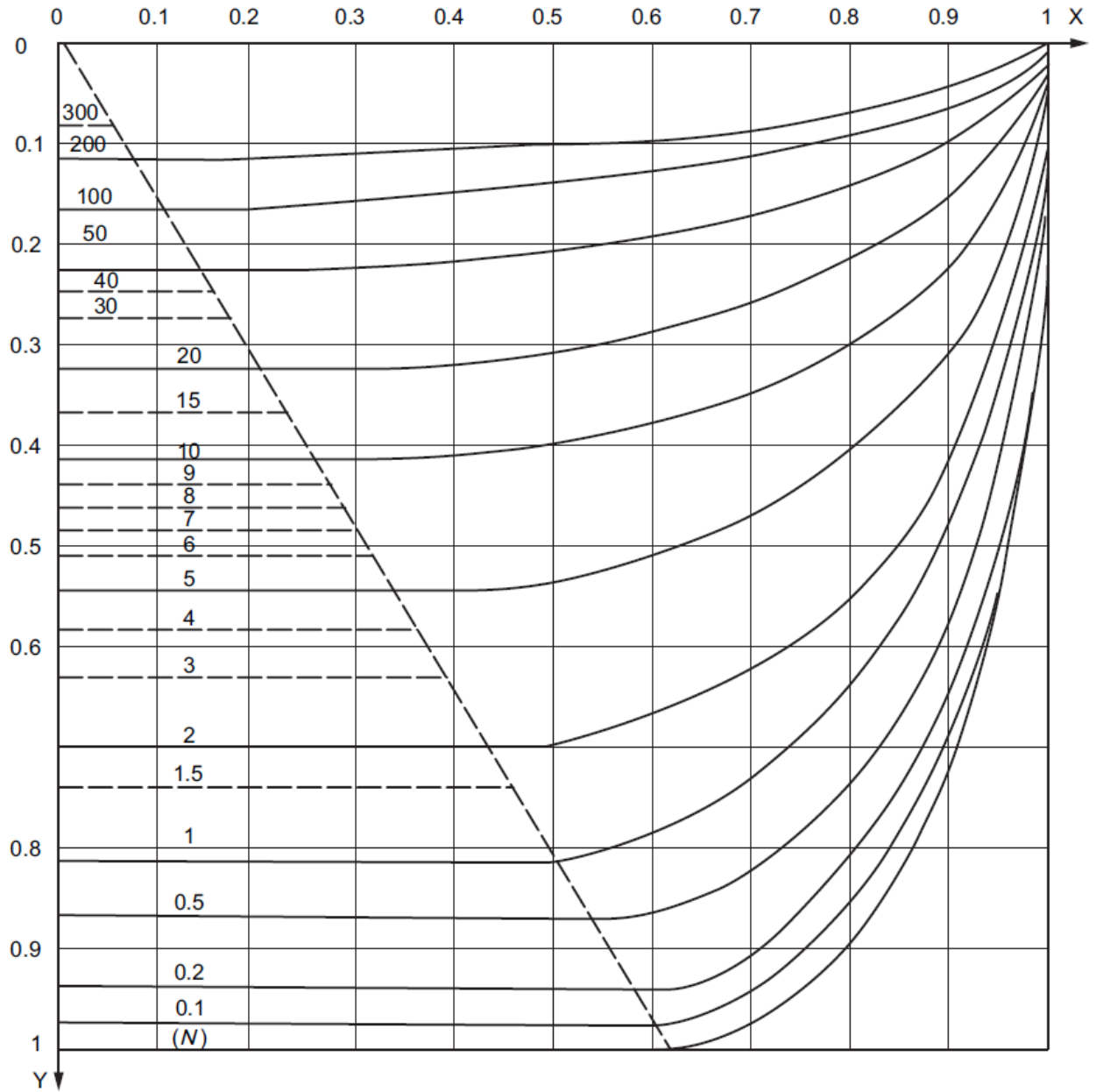

Key

X p_3/p_1 (p_2/p_1 only above diagonal dashed line)
 where

p_3 is the pressure in the reservoir into which the pipe discharges [101 kPa (14.7 psia) with atmospheric discharge];

p_1 is the pressure at upstream low velocity source, expressed in kPa (psia);

p_2 is the pressure in the pipe at the exit or any point a distance, L , downstream from the source, expressed in kPa (psia);

Y G/G_{ci}

NOTE 1 Equations (38) and (39) are based on adiabatic flow and a vapor k value ($= C_p/C_v$) approaching 1.00. For adiabatic flow and with a vapor of $k = 1.40$, the critical mass flux is 12.9 % higher than that calculated with Equations (38) and (39).

NOTE 2 The area below the diagonal dashed line represents sonic flow.

Figure 4—Adiabatic Flow of $k = 1.00$ (i.e. Isothermal Flow) Compressible Fluids Through Pipes at High Pressure Drops

The compressibility factor should be taken at flow conditions and thus changes as the fluid moves down the line with a resulting pressure drop. A stepwise calculation may be employed to allow for this variation. An accurate solution using this method is tedious, but sufficiently accurate results can usually be obtained by performing the calculation over relatively large increments of pipe lengths, using an average compressibility factor over those lengths. Regardless of which equation is used, actual mass flux (G) is a function of critical mass flux (G_{Ci}), frictional resistance (N), and the ratio of downstream to upstream pressure. These relationships are plotted in Figure 4. (Similar charts for adiabatic cases with ratios of specific heats of 1.4 and 1.8 have been developed by Lapple [103].) In the area below the diagonal line in Figure 4, the ratio G/G_{Ci} remains constant, which indicates that sonic flow has been established. The total frictional resistance for use with the chart is expressed by Equation (40):

$$N = \frac{f \times l}{d} + \sum K_i \quad (40)$$

where

N is the pipe frictional resistance factor, dimensionless;

f is the Moody friction factor, dimensionless;

l is the actual length of the pipe, expressed in m (ft);

d is the diameter of the pipe, expressed in m (ft);

K_i are the resistance coefficients of fittings (see Table 9 and Table 10), dimensionless.

Table 9—Typical K -factors for Pipe Fittings

Fitting	K	Fitting	K
Globe valve, open	9.7	90° double-miter elbow	0.59
Typical depressuring valve, open	8.5	Threaded tee through run	0.50
Angle valve, open	4.6	Fabricated tee through run	0.50
Swing check valve, open	2.3	Lateral through run	0.50
180° close-threaded return	1.95	90° triple-miter elbow	0.46
Threaded or fabricated tee through branch	1.72	45° single-miter elbow	0.46
90° single-miter elbow	1.72	180° welded return	0.43
Welded tee through branch	1.37	45° threaded elbow	0.43
90° standard-threaded elbow	0.93	Welded tee through run	0.38
60° single-miter elbow	0.93	90° welded elbow	0.32
45° lateral through branch	0.76	45° welded elbow	0.21
90° long-sweep elbow	0.59	Gate valve, open	0.21
Rupture disk, subcritical flow	1.5 ^a		
NOTE 1 Except for rupture disk data, this table is taken from <i>Tube-Turn Catalogue and Engineering Data Book No. 211</i> [46].			
NOTE 2 K can vary with nominal pipe diameter. The values above are typical only.			
^a $K = 1.5$ has been used successfully for design purposes. Other K values have also been reported [86]. Consult a rupture disk manufacturer for specific data, if required.			

Table 10—Typical K -factors for Reducers (Contraction or Enlargement)

Contraction or Enlargement	K -factors for Various Values of d/d' ^a				
	0	0.2	0.4	0.6	0.8
Contraction (ANSI)	—	—	0.21	0.135	0.039
Contraction (sudden)	0.5	0.46	0.38	0.29	0.12
Enlargement (ANSI)	—	—	0.90	0.50	0.11
Enlargement (sudden)	1.0	0.95	0.74	0.41	0.11

NOTE The K -factors are based on the smaller diameter.

^a d is the inside diameter of the small end of the reducer; d' is the inside diameter of the large end of the reducer.

If a Fanning friction factor is used, Equation (40) reduces to the following expression:

$$N = 4 \frac{f \times l}{d} \quad (41)$$

Figure 4 is used as follows:

- calculate N (number of velocity heads) using Equation (40);
- calculate p_3/p_1 or p_2/p_1 ;
- calculate G_{Ci} using Equation (38) or Equation (39);
- knowing N and either p_3/p_1 or p_2/p_1 , obtain G/G_{Ci} from Figure 4;
- calculate G , in $\text{kg/s} \cdot \text{m}^2$ ($\text{lb/s} \cdot \text{ft}^2$);
- calculate W [the actual flow, in kg/s (lb/s)] as follows:

$$W = G \times A_p$$

where

A_p is the cross-sectional area of pipe, expressed in m^2 (ft^2).

These methods assume that there are no enlargements or contractions in the piping and no variation in the Mach number that results from a change in area.

5.5.7 Fanno Lines Pressure Drop Calculation Method

Another method of calculating pressure drops for ideal gases at high velocities is the use of Fanno lines. Fanno lines are the loci of enthalpy/entropy conditions that result from adiabatic flow with friction in a pipe of constant cross section. Fanno lines extend into both supersonic and subsonic flow zones. For relief disposal systems, only the subsonic flow is of interest. The use of Fanno lines permits the calculation of pressure drops for ideal gases under adiabatic or isothermal flow conditions, with the total piping resistance as a parameter ^[100]. In general, the velocity in gas discharge piping cannot exceed the sonic or critical velocity limit. (This limit is shown on Lapple's charts ^[103] or on Fanno lines.)

5.5.8 Nonideal Gas Behavior

In most disposal systems, the gases being handled are not ideal. For gases, deviations from the ideal are expressed as compressibility factors, which, in turn, are normally correlated with reduced pressure and reduced temperature. For hydrocarbon gases, the compressibility factor is less than 1.0 if the reduced temperature does not exceed 2.0 and the reduced pressure does not exceed about 6.0. Since most PRD disposal systems fall within these limits, the compressibility of the gases is usually less than 1.0. As long as compressibility is less than 1.0, the pressure drop calculated for an ideal gas is larger than that calculated for the same gas incorporating the compressibility factor.

For most applications, the pressure drops that are calculated assuming ideal gases under isothermal flow conditions exceed those calculated by more rigorous procedures. In any design of a disposal system, the sizing of piping based on ideal gas flows under isothermal conditions is normally adequate. However, for very high pressure or high or low temperature situations, the possible effects of deviations from ideality should be checked.

If a rigorous calculation of pressure drop, including the effect of nonideal behavior is necessary or desirable, an incremental or stepwise approach is usually required. It should also be noted that for ideal gases, the specific heat ratio is equal to the isentropic expansion exponent and is independent of pressure. For nonideal gases this is, at best, an approximation. Rigorous pressure drop calculations should be based on the use of the real-gas isentropic expansion exponent and should consider its pressure dependency.

5.5.9 Frictional Resistance of Fittings (*K*-factors)

In any calculation method, the total frictional resistance should include the length of piping and the equivalent length of all fittings, valves, expansion or contraction losses and any other flow resistances. The frictional resistance of fittings and some other items in the piping system can also be expressed in terms of *K*-factors. Table 9 and Table 10 show typical *K*-factors for pipe fittings and for reducers (enlargements and contractions).

When applying the methods of sections 5.5.5, 5.5.6, and 5.5.10, an exit loss ($K = 1$) need not be included when discharging to atmosphere because it is implicit in the solution of the underlying equations^[136]. The friction factor, *f*, enters into all calculations of pressure drop. At high gas flow velocities, which usually prevail in the design of disposal systems, the friction factor approaches a constant number that depends only on pipe size and internal roughness.

For preliminary studies, it is often necessary to assume *K*-factors or an equivalent length of fittings, expansion loops, and the like. Based on actual layouts, these elements can add equivalent length equal to 100 % or more of the physical length of the pipe.

Where gas flow velocity in long runs of piping approaches the critical flow limit, it is often economical to increase the pipe size in steps or progressively along the run. In general, a calculation of pressure drop is required for each section of uniform size. The piping directly connected to a PRD should not be smaller than the size of the outlet flange.

5.5.10 Mixed-phase Fluids

If the system includes mixed-phase fluids (vapor and flashing or nonflashing liquid), the line sizing is more complex. Commercial relief system network-flow simulation programs (see 5.5.4) generally use an equation-of-state model to predict vapor/liquid equilibrium and then apply a two-phase pressure drop equation, with an adjustment in the acceleration term due to the high velocity typical in flare lines, to determine line pressure loss.

There are a number of manual two-phase flashing-flow pressure drop correlations available (see References under headings "Flashing Flow in Pipes" and "Flashing Flow in Valves"). One method is based on the homogeneous equilibrium flow assumption, that is, equal velocity (no-slip) and equal temperature in both liquid and vapor phases^[109]. For the case of a single-diameter, horizontal line, the compressible flow relationship given in Equation (42) can be used to determine pressure drop in multiphase flow systems:

$$\frac{C_1 \times f \times l}{d} = \frac{C_2 \times p_R \times \rho_R}{G^2} \left\{ \frac{\eta_1 - \eta_2}{1 - \omega} - \frac{\omega}{(1 - \omega)^2} \ln \left[\frac{(1 - \omega)\eta_1 + \omega}{(1 - \omega)\eta_2 + \omega} \right] \right\} + \ln \left[\frac{(1 - \omega)\eta_1 + \omega}{(1 - \omega)\eta_2 + \omega} \left(\frac{\eta_2}{\eta_1} \right) \right] \quad (42)$$

where

l is the total equivalent length of pipe having diameter d (including fittings), expressed in m (ft);

d is the inside pipe diameter, expressed in mm (in.);

f is the Fanning friction factor, assumed constant over the length of pipe, dimensionless;

p_R is the reference condition absolute pressure, expressed in kPa (psi);

ρ_R is the reference condition density, expressed in kg/m³ (lb/ft³);

G is the mass flux in the pipe, expressed in kg/h·mm² (lb/h·in.²);

For PRV laterals, use G as the PRV lateral/tail pipe rate specified in Table 8 divided by the pipe cross-sectional area. For headers, use G as the required relief load divided by the pipe cross-sectional area.

$\eta_1 = p_1/p_R$, dimensionless;

$\eta_2 = p_2/p_R$, dimensionless;

p_1 is the pipe inlet absolute pressure, expressed in kPa (psi);

p_2 is the pipe exit absolute pressure, expressed in kPa (psi);

ω is the correlating parameter referenced to p_R , ρ_R [see Equation (44)];

C_1 is a constant, equal to 2000 in SI units ($C_1 = 24$ in USC units);

C_2 is a constant, equal to 0.01296 in SI units (2.898×10^6 in USC units).

As in the case of gases, the pipe outlet pressure, p_2 , depends on whether or not the flow at the end of the pipe is choked. The pipe outlet pressure, p_2 , of a constant-diameter pipe is the higher of the pressure at the exit of the pipe and the critical choking pressure given in Equation (43):

$$p_c = C_3 \times G \sqrt{\frac{\omega \times p_R}{\rho_R}} \quad (43)$$

where

p_c is the critical choking absolute pressure, expressed in kPa (psi);

C_3 is a constant, equal to 8.784 in SI units (5.8742×10^{-4} in USC units);

the definition of the other symbols is the same as for Equation (42).

If the pressure at the pipe exit (e.g. atmospheric pressure or other known pressure) is less than p_c , then the flow is choked. In this case, replace p_2 with p_c in the η_2 term used in Equation (40). Otherwise, the flow is not choked so the pipe exit pressure should be used as p_2 in Equation (40).

The following is a procedure to select the reference conditions for calculating ω for use in Equation (42) and Equation (43).

Step 1—Perform an isenthalpic flash starting from relieving conditions to the maximum expected backpressure (p_B). In many cases involving multiphase relief, a balanced PRV or pilot-operated PRV will be required so for a first try let $p_B \sim 30\%$ to 50% of the PRV set pressure. Let this pressure be the new reference pressure, p_R , and determine the density of the multiphase mixture. This density is the new reference density, ρ_R .

Step 2—Perform an isenthalpic flash from relieving conditions to 50% of the reference pressure, p_R , from Step 1 or atmospheric pressure, whichever is greater. Assign this pressure as p and the multiphase mixture density at this pressure as ρ .

Step 3—Then:

$$\omega = \frac{(\rho_R / \rho) - 1}{(p_R / p) - 1} = \frac{(v / v_R) - 1}{(p_R / p) - 1} \quad (44)$$

where

v is the specific volume, expressed in m^3/kg (ft^3/lb);

v_R is the reference condition specific volume, expressed in m^3/kg (ft^3/lb).

NOTE The value of ω used in Equation (42) and Equation (43) is NOT the same as that used when sizing the PRV in accordance with API 520, Part 1, Annex C.

Step 4—If there is a large pressure drop, repeat Steps 2 and 3 to obtain additional ω values. Use the appropriate ω , p_R , and ρ_R values that most closely correspond to the calculated pressures in each pipe segment.

Equations (42), (43), and (44) are used to calculate either the upstream pressure (i.e. p_1) or the maximum equivalent length of pipe allowed for the specific relief device. If using the equations to determine the upstream pressure, then:

- a) determine ω using Equation (44) and the guidance above;
- b) calculate G and determine the critical pressure, p_c using Equation (43);
- c) if p_c exceeds the outlet pressure p_2 , then set $p_2 = p_c$; otherwise use p_2 directly in Equation (42);

then, $\eta_2 = p_2/p_R$;

- d) calculate the Fanning friction factor;
- e) solve Equation (42) by trial and error for η_1 and then $p_1 = (\eta_1 \times p_R)$;
- f) determine if the selected relief device is appropriate for the calculated p_1 .

If using the equations to determine the maximum allowed equivalent pipe length for a specific type of PRV, then:

- a) determine the maximum allowed backpressure for the specific PRV type, for example, 10 % of set pressure for conventional PRVs, 30 % of set pressure for most balanced-bellows PRVs (without derating), 50 % of set pressure for most pilot-operated PRVs (without derating); set this backpressure equal to p_1 ;
- b) determine ω , using Equation (44) and the guidance above;
- c) calculate G and determine the critical pressure, p_c , using Equation (43);
- d) if p_c exceeds the outlet pressure p_2 , then set $p_2 = p_c$; otherwise use p_2 directly in Equation (42);
then, $\eta_2 = p_2/p_R$;
- e) calculate the Fanning friction factor;
- f) solve Equation (42) directly for l .

5.5.11 Mechanical Design of the Disposal System

The mechanical design of the disposal system warrants the same attention as that given to the design of piping systems that handle process fluids. The problems encountered in the design of discharge piping from PRD or depressuring valves are frequently more complex than those encountered in the design of a process system, since discharge piping can be subject to a greater range of temperature, pressure and shock caused by the wide range of operating conditions. In addition, the disposal system can, at one time or another, contain any material handled in the process system.

The major stresses to which the discharge piping of a relieving system is subject are results of thermal expansion or contraction from the entry of cold or hot materials and thrust developed by the discharge fluid. In relieving systems that serve facilities within the scope of this standard, temperatures can range from well below zero to several hundred degrees. Designing for flexibility is more complicated than it is for process piping systems because thrust as well as thermal expansion shall be controlled.

If there is liquid potential, then the following shall be considered:

- a) the mechanical impact effects of multiphase flow, particularly slug flow, in the piping;
- b) two-phase pressure drop in the piping;
- c) weight loading on the piping supports.

Most situations make it possible to maintain stress levels in relieving systems within allowable limits over the full temperature range by providing guides, anchors, and appropriate piping configurations.

5.5.12 Acoustic Fatigue

5.5.12.1 Background

High pressure drops across valves, orifice plates, changes in piping diameter, or other restrictions in gas piping cause noise downstream because of the flow turbulence that accompanies high pressure drop. The high-energy, high-frequency noise causes high-frequency circumferential vibration in the pipe wall that can result in rapid fatigue failure at asymmetric discontinuities (e.g. branch connections including small-bore connections, welded supports, partial reinforcement pads, etc.). Flow-induced vibration can also be the cause of piping fatigue failure in pressure relieving systems (see Annex H).

The original fatigue screening method published by Carucci and Mueller involved calculation of the sound power level at the noise source and comparison with a recommended design limit based on the pipe diameter^[48]. Subsequently, the UK Marine Technology Directorate published a method to estimate the LOF of welded connections downstream of high noise sources^[116]. The LOF method was developed for systems normally with flow. Its application to normally no-flow sources such as depressuring and PRVs can be overly conservative. The Energy Institute revised and replaced the work of the Marine Technology Directorate^[55]. This subject is an area of active research^[90] so future changes in the design guidance may occur. The user is cautioned that some published methods have been found to contain errors^[49] or have not yet been broadly accepted by industry.

The potential for acoustic fatigue should be evaluated to identify potential high-risk welded pipe connections (e.g. small-bore connections, side branch connections, and welded pipe supports) so that appropriate modifications can be made. There are several different methods that can be used to evaluate acoustic fatigue ^[48, 55].

5.5.12.2 Sound Power Level

The sound power level (internal to the pipe) generated by the pressure reduction source (typically a PRV, depressuring valve, or orifice) is calculated according to Equation (45):

$$L_w = 10 \log_{10} \left[W^2 \left(\frac{P_1 - P_2}{P_1} \right)^{3.6} \left(\frac{T_1}{M} \right)^{1.2} \right] + C_w \quad (45)$$

where

L_w is the sound power level, expressed in decibels (dB);

P_1 is the upstream absolute pressure of pressure letdown source, expressed in kPa (psia);

P_2 is the downstream absolute pressure of pressure letdown source, expressed in kPa (psia);

T_1 is the upstream absolute temperature of pressure letdown source, expressed in K (°R);

W is the gas flow rate, expressed in kg/s (lb/h);

M is the relative molecular mass;

C_w is a constant = 126 in SI units (45 in USC units).

NOTE 1 This is an empirically based internal pipe sound power level calculation only for use with the Carucci/Mueller design curves ^[48]. It is important not to confuse it with predicted control valve sound pressure levels at 1 m downstream of the valve and 1 m outside the downstream piping.

NOTE 2 Equation (45) is applicable to single-flow path devices and fittings in which the pressure drop is taken in a single stage. It should not be used to estimate the sound power from multihole or multistage flow orifices or from valves equipped with low noise trims. Sound power levels used for these specialized low-noise devices should be expressed in a basis consistent with Equation (45) (e.g. do not use the method for sound power in IEC 60534-8-3).

NOTE 3 When sonic flow exists at a branch connection, add 6 dB to L_w from Equation (45) to account for intensified dynamic strain response.

This equation is used only to calculate the sound power level at each source of sonic or near-sonic flow. Attenuation of the sound power as it propagates down the pipe is addressed separately. For example, the sound power is attenuated by 6 dB for every 100 pipe diameters in length downstream of the sound source ^[48]. The fatigue evaluation should extend to a vessel such as a knockout drum, unless new noise sources are located in the piping downstream of the drum.

If more than one parallel and/or series source generates noise (e.g. multiple relief devices venting simultaneously or two restriction orifices in series), the noise shall be added at the pipe junctions where the piping from the sources meets as shown in Equation (46):

$$\sum L_w = 10 \log_{10} \left[10^{L_{w1}/10} + 10^{L_{w2}/10} + \dots + 10^{L_{wn}/10} \right] \quad (46)$$

where

$L_{w1,2,\dots,n}$ is the sound power level for each noise source in the downstream piping, expressed in dB.

Based on the Carucci and Mueller design curve ^[48], a sound power less than or equal to 155 dB should not create any fatigue concern. A sound power level greater than 155 dB should be further evaluated using methods such as in References [48] and [55] or a finite element modeling approach. Systems still identified as a risk using these evaluation methods should be mitigated (see 5.5.12.3).

5.5.12.3 Mitigation Options

Common examples of mitigation options when the sound power level is determined to be excessive include, but are not limited to, the following.

- a) Reducing the mass flow rate and/or pressure drop across a valve.
- b) Selecting depressuring and control valves with low noise trims.
- c) Using thicker walled piping (i.e. lower D/t).
- d) Improving the connection integrity by minimizing pipe fittings and attachments that produce high stress concentrations at the connection. Peak fatigue stress is lower in fittings and attachments with completely symmetric connections (e.g. reducing tees, full-wrap encirclements). Examples of design strategies to minimize stress include the following.
 - 1) Removing the small-bore connection (e.g. hydrostatic vent or low point drain) or relocating to piping segments determined not to be at risk for acoustic-induced vibration fatigue failure.
 - 2) Making branch connections with fittings that ensure a smooth transition from branch to main line. Options to achieve this include reducing tees (which introduce no asymmetric discontinuities) and sweepolets or equivalent (which are asymmetric but with a smooth transition). Common branch connection techniques such as fabricated branch connection (stub-in, stub-on, etc.) are acceptable in piping at risk of acoustic-induced vibration risk only if they are installed with full encirclement reinforcement band or sleeve on the main-line pipe. Weldolets and forged couplings should be avoided unless similarly reinforced. Use a forged or wrought tee fitting to execute the branch connection if available. Where a reducing tee is not available due to the relative sizes of the branch and run pipes, piping reducers (“swages”) can be used to make the transition from small branch pipe to an available reducing tee. In this way, stress concentration due to asymmetric discontinuities in the piping can be avoided.
 - 3) Ensuring that a header seam does not cross the connection weld line.
 - 4) If fabricated branch connections (e.g. stub-in, stub-on, etc.) are unavoidable, use a 90° insertion angle instead of a 45° angle (with, for example, a “laterolet” or “elbowlet”) as these have a better fatigue performance for acoustic excitation. It is noted that the use of a 45° lateral will improve the flow regime and reduce the low-frequency, flow-induced vibration. However, this advantage of the 45° connection is negated in piping at risk of acoustic-induced vibration by the difficulty in the weld penetration at the internal angle.
 - 5) Avoid the use of stub-in or stub-on tees on connections of DN 50 mm (2 in.) or below. Instead, small-bore connections should be made to DN 100 mm (4 in.) or larger branches, which are then tied into the main (i.e. large diameter) subheader or header pipe.
 - 6) Avoiding intrusive fittings (e.g. thermowells).
- e) The following should be considered regarding pipe supports.
 - 1) If any welding attachment is done to the pipe, then the attachment shall not be welded directly to the pipe wall but rather to a full-wrap reinforcement encirclement sleeve or band.
 - 2) Welding full circumferential bands (i.e. “wrapper plates”) directly to the pipe, with pipe support trunions and shoes then attached to the bands. Direct contact between the trunions and support shoes with the pipe should be avoided.

5.5.13 Setting the Mechanical Design Temperature for Flare Headers

5.5.13.1 General

Flare headers are commonly exposed to a broader range of temperature variations than other plant piping. This requires a careful analysis to ensure that the mechanical design can tolerate the full range of expected temperature changes. The analysis shall consider all of the different modes of operation—normal, emergency, start-up, shutdown.

The designer should determine the range of temperatures and pressures of the fluids entering the flare header for each mode of operation. A heat transfer analysis may also be performed that considers the amount of material released and the duration of those events that can cause the header to reach high and low temperature extremes. For example, if an emergency shutdown requires a rapid inventory reduction in a large vessel containing light hydrocarbon liquids, the amount of material released might cause the entire length of the flare header to drop to its minimum temperature. The piping material and the mechanical design shall be capable of tolerating such extremes. Otherwise, the pipe could fail due to brittle stress, or stresses caused by unanticipated pipe contractions. Such a failure has occurred due to rain falling on a header cooled to low temperature causing thermal stress failure.

The fire scenario can result in either high-temperature vapors being discharged in the flare header and/or expose the flare header to the effects of the fire itself. It is common practice to exclude the fire-relief scenario when specifying the maximum design temperature of the flare headers. Regarding fire exposure, there may be situations where fire insulation of the header section(s) is warranted. It is up to the user to determine if and where fire insulation is provided.

The mechanical designer should be presented with a table of operating conditions, based on this careful analysis. If there are any credible operating conditions that cannot be incorporated into the design, then additional layers of protection shall be used.

5.5.13.2 Low-temperature Effects/Brittle Fracture

Special attention to stresses is recommended if piping constructed of carbon steel can be cooled below its transition temperature. Cooling can be caused by the entry of cold materials or by autorefrigeration, which occurs when the pressure on low-boiling liquids is reduced. Reference should be made to ASME B31.3 ^[18] for material specifications, allowable stresses, and impact test requirements for carbon steel piping materials that can be used for temperatures as low as $-46\text{ }^{\circ}\text{C}$ ($-50\text{ }^{\circ}\text{F}$). Stress relieving of welded piping systems has proven beneficial as a supplementary precaution in reducing the risk of brittle fracture of carbon steel piping that can operate below its transition temperature. If temperatures below $-46\text{ }^{\circ}\text{C}$ ($-50\text{ }^{\circ}\text{F}$) are possible, the usual practice is to construct relief lines of materials that exhibit ductile behavior at the minimum anticipated operating temperature.

5.5.14 Reaction Forces

The design of discharge piping requires careful analysis of the possible imposition of both thermal and mechanical stresses on the associated PRDs. The stresses set up in the PRDs can cause malfunction or leakage of the devices (see API 520, Part 2). Forces on the device can be controlled by proper anchors, supports, and provisions for flexibility of discharge piping.

Discharge piping that is supported by the outlet of the PRD instead of being supported separately induces stresses in associated PRDs and inlet piping. Forced alignment of the discharge piping imposes similar stresses. Discharge piping, including short tail pipes, should be examined, supported and carefully aligned as requirements dictate. Strains sufficient to cause mechanical failure usually occur first at the inlet piping; however, moments at much lower levels can cause serious malfunction and leakage of the PRD. Stresses can also be imposed on the disposal piping as a result of reaction forces created when the PRDs are discharging. Provisions should be made for anchoring or restraining disposal lines related to these devices where analysis indicates that this is necessary. An equation for computing reactive loads due to the operation of PRDs is given in API 520, Part 2.

5.5.15 Shock Loading

Shock loading should also be considered in relief lines. Shock loading can result either from the sudden release of a compressible fluid into a multidirectional piping system or from the impact action of liquid slugs at points of change in direction. Reaction forces can occur at each change of direction in the piping.

5.5.16 Pipe Anchors, Guides, and Supports

The design of appropriate and adequate anchors, guides, and supports for a PRD discharge piping system is complex. Sudden changes in flow rate and temperature can produce large reaction forces; if liquids are present in the relief system, the momentum forces can be significant.

There are several methods of calculating piping flexibility; reference should be made to ASME B31.3^[18] for a background discussion. Once the range of relieving conditions to be handled is established, the problems are no different from those for most other piping systems, other than also having to consider thrust forces.

Experience has shown that it is necessary to carefully consider answers to the following questions to permit the design of a satisfactory system of anchors, guides, and supports.

- a) What are the probable combinations of relieving conditions that the manifold needs to handle? What sort of temperature ranges do these conditions impose, considering changes in the ambient temperature? What are the probable inlet conditions, in terms of thermal movement, when these reliefs occur?
- b) What are the probable magnitude and sources of any liquid slugs?
- c) Are there any valves that can release large volumes of high-pressure gas and produce shock loads? If so, where are they located?

In general, it is preferable to select anchor points so that header movements and the resultant forces and moments are not imposed on the bodies or the discharge piping of PRVs. If PRDs discharge to the atmosphere, the tail pipe configuration should be checked for discharge reaction forces to ensure that it will not be overstressed.

5.5.17 Self-draining/Heat Tracing

Disposal system piping should be self-draining toward the discharge end. Pocketing of discharge lines should be avoided. If PRDs handle viscous materials or materials that can solidify as they cool to ambient temperature, the discharge line should be heat traced. A small drain pot or drip leg can be necessary at low points in lines that cannot be sloped continuously to the knockout drum. The use of liquid drain traps or other devices with operating mechanisms should be avoided.

5.5.18 Routing of Discharge Piping/Sloping

Many design details and features merit particular emphasis with respect to relieving systems. The following points shall not be taken as definitive or restrictive.

- a) The laterals from individual relieving devices should normally enter a header from above. This tends to keep any liquids that flows or develops in the header out of the laterals to each valve.
- b) Laterals that lead from individual valves located at an elevation above the header should drain to the header. Locating a PRD below the header elevation in closed systems should be avoided wherever possible. Laterals from individual devices that need to be located below the header should be arranged to rise continuously to the top of the header entry point; however, means should be provided to prevent liquid accumulation on the discharge side of these valves.
- c) A slope of 21 mm in 10 m ($1/4$ in. in 10 ft) is suggested for all laterals and headers, taking into account piping deflections between supports.

- d) Where individual devices are vented to the atmosphere, an adequate drain hole [NPS of DN 15 (NPS 1/2) is usually considered suitable] should be provided at the low point to ensure that no liquid collects downstream of the device. The vapor flow that occurs through this hole during venting is generally not considered significant, but each case should be checked to see if the drain connection should be piped to a safe location. Vapors escaping from the drain hole should not be allowed to impinge against the vessel shell, since accidental ignition of such vent streams can seriously weaken the shell.
- e) The use of angle entry, for example, an entry at 0.79 radian (45°) or even 0.52 radian (30°) to the header axis, for laterals is much more common in relieving systems than in most process-piping systems. The two main reasons for this approach are:
- 1) lower pressure drop (including velocity head losses), and
 - 2) reduced reaction forces.

Since laterals in relieving systems can often be sized at velocities approaching sonic, pressure losses or recoveries caused by velocity change can become a significant factor in system analysis. These resultant density changes can produce large reaction forces.

- f) The use of block valves to section the header system for maintenance or safety should be considered. Such block valves should be provided with locking or sealing devices. Where block valves cannot be justified, the provision for blinding should be studied. In locating sectioning block valves or blinds, extreme caution should be exercised in their use to ensure that equipment which is operating is not isolated from its relieving system. If block valves are used in the header system, they should be mounted so that they cannot fail in the closed position (an example would be a gate falling into its closed position). Procedures should address the possibility of exposing workers to flare gas from a relief scenario that occurs while they are blinding the flare system if there are no isolation valves. In some cases, the header can be operating under a vacuum (stack draft), in which case air can be drawn into the header resulting in the potential formation of explosive-combustible mixtures.

5.6 Disposal to a Lower-pressure System

Discharge of the relieved material to the same or another system at lower pressure can be a safe and economical method, provided that the receiving system is designed for the additional load.

The particular type of process unit selected determines whether a lower-pressure process system exists that can safely receive material relieved from a higher-pressure system. This is usually true with liquid reliefs (e.g. liquid relieved from the discharge side of a pump being disposed to the suction side). Selection of the type of valve used (i.e. a balanced or a conventional PRV) depends on the backpressure (constant, variable, or built-up) of the lower-pressure system.

5.7 Disposal to Flare

5.7.1 General

The primary function of a flare is to use combustion to convert flammable, toxic, or corrosive vapors to less objectionable compounds. Selection of the type of flare and the special design features required are influenced by several factors, including the availability of space; the characteristics of the flare gas, namely, composition, quantity and pressure level; economics, including both the initial investment and operating costs; and public relations. Public relations can be a factor if the flare can be seen or heard from residential areas or navigable waterways. Other topographic considerations include elevations of land and neighboring land, elevations of equipment (especially where personnel might need to be present), and proximity to utility and electrical systems (e.g. electric lines or control wire runs). The designer needs to know these and other factors in the determination of noise, thermal radiation, liquid carryover, and vapor dispersion. For example, a flare near a hill or in a valley can be influenced by wind direction and downward turbulence. Note that flares are considered pollution-abatement equipment and are usually subject to environmental regulations and permitting requirements for their use and location. Flare design requires both API 537 and API 521. Flare design aspects include, but are not limited to:

- a) combustibility of the fluid being flared (see F.1.1);
- b) thermal radiation (see 5.7.2 and F.2);
- c) flame stability (see API 537);
- d) flaring toxic gases (see 5.7.3);
- e) destruction efficiency (see API 537);
- f) combustion methods (see 5.7.4);
- g) smoking/smokeless performance (see API 537);
- h) cautions on freezing and icing in flares (see 5.7.5);
- i) flare noise (see API 537);
- j) flare tip pressure drop (see API 537);
- k) purging/air ingress/flashback prevention (see API 537 and 5.7.6);
- l) ignition system (see API 537);
- m) liquid seal drums (see 5.7.7);
- n) liquid removal (knockout drums) (see 5.7.8);
- o) siting and safe dispersion for loss of flame/safe dispersion of combustion products (see 5.7.9);
- p) flare gas recovery systems (see 5.7.10);
- q) mechanical design, operation, and maintenance of flare equipment (see API 537).

API 537 also provides datasheets for exchanging both process and mechanical design information.

An example for sizing the flare stack is given in C.2. This example applies the preliminary screening equations for thermal radiation given in F.2.

5.7.2 Thermal Radiation

5.7.2.1 Effect on Human Skin

Many investigations have been undertaken to determine the effect of thermal radiation on human skin. Using human subjects, Stoll and Greene^[157] found that with an intensity of 6.3 kW/m² (2000 Btu/h·ft²), the pain threshold is reached in 8 s and blistering occurs in 20 s. On the bare skin of white rats, an intensity of 6.3 kW/m² (2000 Btu/h·ft²) produces burns in less than 20 s. The same report indicates that an intensity of 23.7 kW/m² (7500 Btu/h·ft²) causes burns on the bare skin of white rats in approximately 6 s. Table 11 gives Buettner's^[37] exposure times necessary to reach the pain threshold as a function of radiation intensity. These experimental data were derived from tests given to people who were radiated on the forearm at room temperature. The data indicate that burns follow the pain threshold fairly quickly. Buettner's data agree well with those of Stoll and Greene. Tissue damage starts with a burn that resembles a mild sunburn. As exposure time and/or radiation intensity increases, the burn progresses to a severe sunburn and with further exposure into more serious tissue damage.

Table 11—Exposure Times Necessary to Reach the Pain Threshold

Radiation Intensity kW/m ² (Btu/h·ft ²)	Time-to-pain Threshold s
1.74 (550)	60
2.33 (740)	40
2.90 (920)	30
4.73 (1500)	16
6.94 (2200)	9
9.46 (3000)	6
11.67 (3700)	4
19.87 (6300)	2

Since the allowable radiation level is a function of the length of exposure, factors involving reaction time and human mobility should be considered. In emergency releases, a reaction time of 3 s to 5 s may be assumed. Perhaps 5 s more can elapse before the average individual seeks cover or departs from the area, which would result in a total exposure period ranging from 8 s to 10 s. In evaluating the emergency procedures, consideration may also be given to an exposed individual becoming incapacitated during an attempt to exit the area.

As a basis of comparison, the intensity of solar radiation is in the range of generally 0.79 kW/m² to 1.04 kW/m² (250 Btu/h·ft² to 330 Btu/h·ft²) depending on geographical location and time of year. Solar radiation can be a factor for some locations, but its effect added to flare radiation has only a minor impact on the acceptable exposure time.

The flare user/operator shall determine the need for a solar-radiation-contribution adjustment to the values given in Table 12 on a case-by-case basis. While an adjustment of 0.79 kW/m² to 1.04 kW/m² (250 Btu/h·ft² to 330 Btu/h·ft²) to a 6.31 kW/m² (2000 Btu/h·ft²) level has a relatively small impact on flare cost, the same adjustment to a 1.58 kW/m² (500 Btu/h·ft²) level results in a significant increase in cost. This determination can include, among other things, an analysis of the frequency of maximum radiation flaring, the probability of personnel or the public being near the flare during a maximum flaring incident, the probability of the sun and flame being aligned in such a manner as to have additive intensities, and the ability of the personnel or the public to avoid or move away from the exposure.

Table 12—Recommended Design Thermal Radiation for Personnel

Permissible Design Level <i>K</i> kW/m ² (Btu/h·ft ²)	Conditions
9.46 (3000)	Maximum radiant heat intensity at any location where urgent emergency action by personnel is required. When personnel enter or work in an area with the potential for radiant heat intensity greater than 6.31 kW/m ² (2000 Btu/h·ft ²), radiation shielding and/or special protective apparel (e.g. a fire approach suit) should be considered. Safety Precaution—It is important to recognize that personnel with appropriate clothing^a cannot tolerate thermal radiation at 9.46 kW/m² (3000 Btu/h·ft²) for more than a few seconds.
6.31 (2000)	Maximum radiant heat intensity in areas where emergency actions lasting up to 30 s can be required by personnel without shielding but with appropriate clothing. ^a
4.73 (1500)	Maximum radiant heat intensity in areas where emergency actions lasting 2 min to 3 min can be required by personnel without shielding but with appropriate clothing. ^a
1.58 (500)	Maximum radiant heat intensity at any location where personnel with appropriate clothing can be continuously exposed.

^a Appropriate clothing consists of a hard hat, a long-sleeved shirt with cuffs buttoned, work gloves, long-legged pants, and work shoes. Appropriate clothing minimizes direct skin exposure to thermal radiation.

Flare system design and plant equipment layout should minimize the need for operator attendance and equipment installed in locations of high radiant heat intensity. The impact of multiple flares in proximity operating simultaneously needs to be considered when evaluating thermal radiation.

The design of towers or other elevated structures exposed to flare radiation should consider radiation effects on the ability to safely egress. If personnel exposure to radiant heat exceeds the guidelines provided above, then shielding or other protection should be considered. It is often most effective to accomplish this by locating ladders and platforms on a side away from the flare.

Personnel are commonly protected from high thermal radiation intensity by restricting access to any area where the thermal radiation can exceed 6.31 kW/m^2 ($2000 \text{ Btu/h}\cdot\text{ft}^2$). The boundary of a restricted access area can be marked with signage warning of the potential thermal radiation exposure hazard. Personnel admittance to, and work within, the restricted access area should be controlled administratively. It is essential that personnel within the restricted area have immediate access to thermal radiation shielding or protective apparel suitable for escape to a safe location.

Another factor to be considered regarding thermal radiation levels is that clothing provides shielding, allowing only a small part of the body to be exposed to full intensity. In the case of radiation emanating from an elevated point, standard personnel protective measures, such as wearing of a hard hat, can reduce thermal exposure.

There are practical differences between laboratory tests and full-scale field exposure^[36, 82]. Heat radiation is frequently the controlling factor in the spacing of equipment such as elevated and ground flares. Table 12 presents recommended design total radiation levels for personnel at grade or on adjacent platforms. The extent and use of personal protective equipment can be considered as a practical way of extending the times of exposure beyond those listed.

The effects of thermal radiation on the general public, who can be exposed at or beyond the plant boundaries, should be considered.

Each company may select the radiation level to which personnel can be exposed, either for a short duration or continuously. Table 12 is provided to guide companies in making this decision. However, many factors can influence the radiation levels to which personnel may be continuously exposed. The following are some of these factors.

- a) Environmental—Wind and ambient temperature can influence the amount of radiation a person can withstand.
- b) Design—Factors such as orientation of the work place with respect to the flare and shielding can both impact on personnel radiation exposure.
- c) Training—Properly trained workers wear appropriate clothing and know how to react to changing situations.

It is expected that each company evaluate the impact of these factors to determine a safe level of radiation exposure for their personnel.

5.7.2.2 Effect on Equipment

In most cases, equipment can safely tolerate higher degrees of heat density than those defined for personnel. However, if any items vulnerable to overheating problems are involved, such as construction materials that have low melting points (e.g. aluminum or plastic), heat-sensitive streams, flammable vapor spaces, and electronic or electrical equipment, then the effect of radiant heat on them might need to be evaluated. If an evaluation is necessary, a heat balance can be performed to determine the resulting surface temperature for comparison with acceptable temperatures for the equipment^[36].

5.7.2.3 Thermal Radiation Calculation Methods

F.2 provides a method to calculate thermal radiation levels that can be used for preliminary screening. It is recommended that the manufacturer of the specific flare tip be consulted to determine/verify the thermal radiation levels. C.2 provides a flare stack sizing example using the F.2 method for thermal radiation.

5.7.3 Flaring Toxic Gases

The flaring of toxic gases requires special considerations. Some information can be obtained from a test program sponsored by the Environmental Protection Agency (EPA) through the Chemical Manufacturers Association (CMA). The destruction efficiency for certain combustible toxic material in a properly operated flare can be in the range of 98 % ^[60]. Consult the flare manufacturer to determine destruction efficiency and combustion efficiency for specific flare scenarios and flare types.

5.7.4 Combustion Methods

Disposal of combustible gases, vapors, and liquids by burning is generally accomplished in flares. Flares are used for environmental control of continuous flows of excess gases and for large surges of gases in an emergency. The flare is usually required to be smokeless for the gas flows that are expected to occur from normal day-to-day operations. This is usually a fraction of the maximum gas flow, but some environmentally sensitive areas require 100 % smokeless or even a fully enclosed flare. The smokeless burning expectations should be explicitly defined. In API 537, smokeless capacity is defined on datasheets in kg/h (lb/h) rather than some percentage of design flow. The smokeless capacity requirement should be established by a review of actual flaring scenarios. Conditions that are expected to occur often enough to require smokeless operation, either by regulation or company standards, should set the smokeless requirement. Indicate the opacity or Ringelmann number that is allowable at the flow rate for smokeless operation. Attempts to shortcut the establishment of factually based smokeless burning requirements by setting the smokeless flow rate as a percentage of the maximum emergency flow rate can lead to disappointment or needless expense.

Various techniques are available for producing smokeless operation, most of which are based on the premise that smoke is the result of a fuel-rich condition and is eliminated by promoting uniform air distribution throughout the flames. API 537 provides a description of the most common techniques employed for providing smokeless operation. In addition to smokeless operating requirements, stricter flaring regulations (federal, state, and local) are constantly evolving and, in most areas, typically include low-noise levels, limits on smoking reliefs, continuous pilot monitoring, limits on tip-exit velocities, and minimum heat content of the flare gas. Current regulations should always be consulted for detailed flaring requirements.

5.7.5 Freezing and Icing in Flare Tips

5.7.5.1 Steam-assist Flares in Cold Climates

Design and operation of a steam injection system in cold climates where ice formation can occur needs to be performed with care as steam can condense and freeze within the flare stack. This has been experienced both with injection from an internal center steam nozzle and upper steam ring (see API 537). In low-temperature conditions, this may result in partial or full blockage of the flare stack or flare header.

Consideration should be given to the following:

- a) supplying steam to an internal steam nozzle through a separately controlled steam line so that it can be turned off in cold conditions;
- b) ensuring minimum steam flow and/or superheating are high enough to avoid condensation in the flare tip upper steam ring (condensate can eject from the upper steam ring and fall into and freeze inside the flare stack and/or flare header, creating the risk of a restriction and/or an ice plug in freezing temperatures);
- c) ensuring proper layout and insulation of piping and valves (having the pressure let down as close to the flare stack as possible will reduce heat loss and condensation);
- d) establishing inspection/maintenance routines to detect possible leakages in steam riser (as such leakage will lead to increased risk of condensation in upper steam ring);
- e) ensuring adequate condensate removal located near the steam riser.

Improper sequencing of the steam on a multiple steam injection tip/burner can cause burnback in the flare tip (see API 537).

5.7.5.2 Low-pressure Forced-air Flares in Cold Process Service

The user is cautioned when flaring cryogenic or cold vapors (below 0 °C) that there is potential for condensation and freezing of moisture in the assist air leading to blockage of the flare gas flow paths. This has been experienced with tankage/loading flares in LNG service during continuous flaring.

Consideration should be given to the following:

- consulting the flare vendor to ensure the suitability of the design to avoid ice buildup (e.g. to avoid designs with narrow flow paths and cold bridges between flare gas and assist air passages);
- ensuring that all credible operating modes and durations are identified to the vendor and fully documented to specify the worst-case design basis.

Operating company design basis documentation should include clear statements of the intended operating envelope of the flare system, including flaring scenarios that have been either included or excluded from the flare's design basis.

5.7.6 Purging

5.7.6.1 Flare Stack Purge

See API 537.

5.7.6.2 Other Purging Requirements

Note that purge rates higher than those given by API 537 may be required for the following reasons:

- a) to establish an initial, air-free condition during start-up;
- b) in transient conditions associated with a passing rainstorm cooling down header exposed to the sun;
- c) after venting a hot condensable release into the flare header;
- d) after venting a stream containing significant amounts of compounds that are easily detonated or have unusually wide flammability limits.

Gases or vapors with unusually high burning velocities, such as hydrogen and acetylene, should be evaluated for the possibility of flashback (see API 537).

5.7.6.3 Control of Purge Rate

Once the required quantity of purge gas has been established, the injection rate should be controlled by a fixed orifice, rotameter, or other device that ensures the supply remains constant and is not subject to instrument malfunction or maladjustment. Consult the vendor to determine purge rates to prevent burning inside the flare tip.

5.7.7 Liquid Seal Drum

5.7.7.1 General

An example of liquid seal drum is provided in Figure D.1. A seal drum can also be vertical drum. If used, the purpose of a liquid seal in a flare system includes the following:

- a) to prevent any flashback originating from the flare tip from propagating back through the flare system;
- b) to maintain a positive system pressure to ensure no air leakage into the flare system and permit use of a flare gas recovery system;
- c) to provide a method of flare staging between an enclosed flare and a full size emergency flare;
- d) to prevent an ingress of air into the flare system during sudden temperature changes or condensation of flare gas, such as can occur following a major release of flare gas or following a steaming operation.

Liquid seals are located between the main knockout drum and the flare stack and are quite often incorporated into the base of the stack. They are sized for the maximum vapor-release case. When equipment, piping elevations, and other factors permit, liquid seal volume and seal leg height should be sufficient to prevent the seal from being broken as a result of the vacuum formed in the flare header following a major release of flare gas or steaming operation.

For facilities that have cryogenic products in the flare header, consideration should be given to the effect of the cold material on the seal liquid medium. Water seals are not recommended where there is a risk of obstructing the flare system due to an ice plug. Alternate sealing fluids such as glycol/water mixture may be considered. Alternatively, methods such as heating the seal fluid or draining the seal when cold temperature is detected have been used. See 5.7.7.2 through 5.7.7.9 for detailed design guidance.

An example of liquid seal drum is provided in Figure D.1. The seal drum can also be a vertical drum.

5.7.7.2 Purpose of Liquid Seal Drums

A liquid seal drum can have many uses as set forth in 5.7.7.1. A liquid seal is sometimes used to prevent air entry into the flare header system. Following a hot release, cooling, and/or condensation of vapor at low-flow or no-flow conditions can form a vacuum condition in the flare header. Under such conditions, air can be drawn into the flare system through the flare tip. The rate of contraction accelerates dramatically if the cooling leads to condensation of components of the contained gas.

Factors to consider when assessing this potential are as follows:

- a) the potential contraction of the contained gas when cooled;
- b) the volume of the flare system;
- c) the vacuum rating of the flare system; and
- d) the anticipated cooling rate of the flare system, which can be affected by insulation or sudden cooling from wind and rain.

To prevent air entry, it is necessary that the seal dip-leg height and the density and amount of seal liquid within the drum be sufficient to prevent the seal from being broken as a result of the vacuum formed in the flare header. The physical dip-leg height is measured from the top opening of the seal head or end piece (e.g. the top of the V-notches on the end of the pipe) to the bottom of the horizontal section of the flare header piping immediately upstream of the inlet leg. The relative elevations of the flare header and other equipment and other factors can limit the vacuum sealing capability. If it is necessary to have the liquid seal inlet some height above the flare header elevation, then the flare header shall be sloped to avoid low points. The seal drum should be designed to provide the volume of liquid (without credit for makeup liquid) to fill the vertical seal leg up to the specified vacuum. It is important that the purchaser states this performance requirement on the datasheet.

Experience has shown that a minimum dip-leg height of 3 m (10 ft) above the liquid level [i.e. ~34.5 kPa (5 psi) vacuum if water is used as the seal liquid] is effective in minimizing the ingress of air into the flare header from flare stacks for typical refining applications. A tank-blanketing regulator, pressure regulator, and/or pressure switch/transmitter that dumps extra purge gas into the flare header system in the event of vacuum can also be considered in addition to, or in place of, the water seal.

In some situations, special considerations can affect the size of a seal drum. One such occurrence is a large flow of hot vapor into the vent header. The vacuum created when this vapor cools can pull sufficient liquid into the header to break the seal, thus allowing air to be drawn into the flare system. To prevent this occurrence, the inlet line should be constructed to form a vacuum leg. The total vertical height of the inlet leg at the seal drum is determined by the maximum vacuum expected. The volume of liquid in the inlet line at the maximum vacuum should be obtained from the seal drum. This requirement can necessitate an increase in the size of the drum.

The flare header pressure at which gas begins passing through the seal can vary depending upon the purpose of the water seal (i.e. prevent air infiltration, act as a flame arrester, act as a staging device or provide backpressure to a flare gas recovery system). The gas pressure at the start of flow through the liquid seal can vary from 50 mm (2 in. H₂O) to 3050 mm (120 in. H₂O) or more. Typical seal depths are equivalent to a gauge pressure of 13.8 kPa to 34.5 kPa (2 psi to 5 psi) for staged flares or 6.9 kPa to 13.8 kPa (1 psi to 2 psi) where a flare gas recovery system is used. For general applications, a seal depth of 150 mm (6 in.) is common. In normal operation, a gas flow that exceeds the lower-stage capacity or capacity of the flare gas recovery unit causes waste gas to start flowing through the seal.

5.7.7.3 Noise Caused by Seal Drums

Pulsing combustion noise at the flare tip is a problem sometimes encountered relating to seal drums. A properly designed and operated liquid seal should allow gas to pass through the seal with minimal surging in gas flow and/or upstream gas pressure. The design of the liquid seal internals and the sizing of the vessel can have a significant impact on the ability of the seal to meet this performance objective.

For example, a common design for the end of a dip-leg pipe uses V-notches cut into the end of the pipe wall. The design is less effective than the proprietary designs developed by vendors of liquid seals. These proprietary designs that use alternative design guidelines can offer economic or operational advantages.

Another example to control pulsing is to control liquid sloshing during a release by including antisloshing baffles, which act to dampen any pressure fluctuations created by the liquid movement in the drum (see Reference [154]).

The purchaser should determine the applicability of such designs to the purchaser's system and situation. Additional discussion of liquid seals and examples of alternate seal head designs can be found in Reference [33].

5.7.7.4 Seal Details

A nonuniform velocity profile through the drum or sloshing due to movement (e.g. on floating facilities) can cause loss of liquid seal and/or ejection of seal liquid through the flare; design elements may need to be incorporated to prevent this.

An oil-skimming device should also be included in the design, which allows the removal of any hydrocarbon liquid that condenses as it passes through the liquid seal. Skimming helps prevent re-entrainment of hydrocarbon into the flare gas stream. The skimming device can be connected to a free-flowing drain or loop seal. The mechanical depth of the loop seal should give consideration to the maximum vessel pressure under any operating condition, as well as the minimum specific gravity of the liquid in the loop seal.

5.7.7.5 Liquid Seal Selection

Liquid seals typically use water as the seal medium; however, other fluids are possible. Fluid selection requires consideration of freeze protection in cold climates, hydrocarbon/water separation, implications of carryover, compatibility with the relief stream, cost, availability, and disposal. In facilities that have cryogenic products released into the flare header, consideration should be given to the effect of the cold material on the seal medium. Water seals are not recommended if there is a risk of obstructing the flare system due to an ice plug. Alternate sealing fluids such as a glycol/water mixture or other means to prevent freezing can be required.

Consideration should be given to providing a continuous flow of seal fluid (typical for water seals), which allows for the continuous skimming of hydrocarbons as well as maintaining liquid level. Proper liquid seal drum operation is dependent upon maintaining the design liquid level in the seal. Routine surveillance and hydrocarbon skimming, if applicable, are required to ensure proper seal operation.

Seal drums that overflow to open sewer should be evaluated as to whether condensed flammable and/or toxic vapors can be discharged and the need to provide suitable containment and/or mitigation systems.

5.7.7.6 Maintenance/Supervision of Seal Drums

Like many components of a flare system, liquid seal drums are generally in a position where they can be maintained only on a full plant shutdown. However, normal inspection and operational maintenance of liquid seal drum ancillaries should be carried out by the operators as part of their rounds. Check level instrumentation and gauges including any alarms, pump out switches, etc. in accordance with vendor recommendations. Also look for any leaks or signs of corrosion, especially on connections and flanges. Leaks should be reported and corrected, since a leak can allow gas to escape from the flare or air to enter the flare at low flow rates and draft conditions from high-temperature or low-density flare gas.

The drum level should be checked in the field on a regular basis: field versus any remote level indication. Since liquid seals are typically considered a “dirty” service and tend to act as a scrubber removing any solids or liquids, routine cleaning of gauge glasses can be required. Dirt buildup can also plug the drain or overflow; these should be checked periodically to determine that they are still functional.

When performing seal drum inspections and maintenance, thermal radiation effects on personnel should be considered (see 5.7.2).

Depending on the flare waste gases, sampling of the seal liquid (normally water) is recommended for a new flare seal drum (or a drum in which the service has been changed) during the initial few months or even the first year of operation. Liquid samples from the seal drum should be checked for levels of sulfur, chlorinated wastes, or other components that can damage the seal drum and internals. Check with the vendor for specific limitations. Proper sampling procedures should be followed to prevent the leakage of flare gas or air entry into the flare. If any problem substances are found, then consider a continuous water flush or treatment program on the water seal to protect it and the stack in accordance with vendor recommendations.

There is also a potential for the presence of pyrophoric iron in the liquid seal drum. When any vessel entry is being planned, the potential for presence of this material should be included in the considerations for safe entry.

During plant shutdown, inspect the internals of the liquid seal drum (such as bubble plate) for fouling or plugging, remove any buildup of dirt or foreign matter and check for corrosion. Report any major corrosion in order that these sections can be repaired or replaced, as needed.

Caution—Only open the seal-drum-access manway after the complete flare system has been shut down, blinded, and purged of all hydrocarbons, gases, and vapors. Check oxygen level and follow plant safety procedures before entry (confined space). Inspection approximately once every 2 years or less is recommended if liquid seal pressure drop increases or pulsations occur.

Warning—Possible gas leaks from the liquid seal drum can be caused by the following:

- a) **excessive backpressure from fouling, freezing, or plugging of the flare equipment (arrestor, burner, or flare stack), which can displace water from the overflow and/or drain U-trap, thus allowing gas to escape; pressures downstream of seal should be monitored to ensure that pressures are not exceeded;**
- b) **loss of liquid in water seal and trap, which shall always be filled with liquid to contain the flare gas.**

5.7.7.7 Calculation of Required Seal Depth

Sizing depends on whether the drum is horizontal or vertical. As previously discussed, the size will have to consider liquid volume required for the seal, pulsing, and liquid vapor separation. The minimum diameter of a vertical seal drum is determined by the total seal liquid volume required from Equation (47):

$$D = d \sqrt{\left(\frac{H}{h} + 1\right)} \quad (47)$$

where

- D is the inside diameter of the drum, expressed in m (ft);
- H is the required seal fluid height for the specified vacuum, expressed in m (ft);
- h is the dip-leg submersion height, expressed in m (ft);
- d is the inside diameter of the inlet piping, expressed in m (ft).

For a horizontal drum this criteria typically does not control the drum diameter because the length of the drum can easily be adjusted to get sufficient seal liquid volume. The volume of seal fluid in a horizontal seal drum shall be adequate to fill the dip-leg. Equation (48) provides the minimum free liquid surface area (L times w) to satisfy the sealing requirement. Optimization of the L and w dimensions can be done subsequently.

$$L \times w = \frac{\pi d^2 H}{4 h} \quad (48)$$

where

- H is the required seal fluid height for the specified vacuum, expressed in m (ft);
- h is the dip-leg submersion height, expressed in m (ft);
- d is the inside diameter of the inlet piping, expressed in m (ft);
- L is the length of the seal liquid surface, expressed in m (ft);
- w is the chord representing the liquid surface width, expressed in m (ft).

The dip-leg submersion height (h) can be established as follows. As described in 5.7.7.1, the flare header pressure at which gas begins passing through the drum can vary. The submergence depth is set by this pressure with due consideration for the specific gravity of the seal fluid [see Equation (49) and Equation (50)]. This backpressure should not exceed the maximum backpressure allowable in the vent header (see 5.5.2). This backpressure sets the maximum distance, h [see Equation (49) and Equation (50)], that the inlet pipe is submerged.

In SI units:

$$h = \frac{102 p}{\rho} \quad (49)$$

In USC units:

$$h = \frac{144 p}{\rho} \quad (50)$$

where

- h is the maximum distance the inlet pipe is submerged, expressed in m (ft);
- p is the maximum pressure difference across the liquid seal, expressed in kPa (psi);

NOTE The absolute pressure at the outlet of the liquid seal under nonflowing conditions will differ from local barometric pressure by any density head difference between the gas inside the flare or vent stack and the local atmosphere at the seal elevation outside the stack.

- ρ is the sealing liquid density, expressed in kg/m³ (lb/ft³).

5.7.7.8 Prevention of Pulsing

The area for the gas flow above the liquid level should be at least three times the inlet pipe cross-sectional area to prevent surges of gas flow to the flare. However, this criterion often does not establish drum size because liquid re-entrainment and total seal liquid volume criteria typically result in larger seal drums.

The diameter of a vertical drum based upon avoiding pulsing is determined by providing an area ratio 1:3. This can be derived assuming a vertical vessel that has an internal area equal to $(\pi D^2)/4$ and an inlet pipe with an area equal to $(\pi d^2)/4$. The annular area is $(\pi/4)(D^2 - d^2)$. Because the ratio is 1:3, then:

$$(D^2 - d^2) = 3d^2 \quad \therefore D^2 = 4d^2 \quad \therefore D = 2d \quad (51)$$

where

d is the inside diameter of the inlet piping, expressed in m (ft);

D is the inside diameter of the drum, expressed in m (ft).

An alternative to the above approach would be to provide proprietary antipulsation devices. Consult the manufacturer for additional information.

5.7.7.9 Liquid Vapor Separation

The height of the vapor space in a vertical seal drum should be approximately 0.5 to 1.0 times the diameter, D , to provide disengaging space for entrained seal liquid. A minimum dimension of 1 m (3 ft) is suggested.

For a horizontal drum, the area available for vapor is the space above the chord set by the maximum liquid level and is set based on vapor-liquid separation criteria that typically exceed the 1:3 area ratio.

A seal drum contacts the gas with seal fluid and any hydrocarbon that has condensed and not been removed by skimming. The liquid vapor separation method described in 5.7.8.5 should be used to establish the drum size. When using this calculation for a seal drum the liquid load from a release is ignored because the upstream knockout facilities should remove the liquid. The space available for separation is that above the normal seal liquid level.

5.7.8 Flare Knockout Drum

5.7.8.1 General

Flare systems generally require a flare knockout drum to separate liquid from gas in the flare system and to hold the maximum amount of liquid that can be relieved during an emergency situation.

Knockout drums are typically located on the main flare line upstream of the flare stack or any liquid seal. If there are particular pieces of equipment or process units within a plant that release large amounts of liquid to the flare header, it is desirable to have knockout drums inside the battery limits to collect these liquids. This reduces the sizing requirements for the main flare knockout drum, as well as facilitates product recovery.

The location of the flare knockout drum should consider the following:

- a) condensation of vapor or agglomeration of liquid droplets if there is a long line between the flare knockout drum and the flare stack resulting in increased liquid droplet size;
- b) personnel access for maintenance on the knockout drum during normal and emergency flaring;
- c) thermal radiation effects on flare knockout drum instrumentation and necessity for thermal shielding.

5.7.8.2 Types of Knockout Drums

The economics of drum design can influence the choice between a horizontal and a vertical drum. If a large liquid storage capacity is desired and the vapor flow is high, a horizontal drum is often more economical. Also, the pressure drop across horizontal drums is generally the lowest of all the designs. Vertical knockout drums are typically used if the liquid load is low or limited plot space is available. They are well suited for incorporating into the base of the flare stack.

Although horizontal and vertical knockout drums are available in many configurations, the differences are mainly in how the path of the vapor is directed. The various configurations include the following:

- a) horizontal drum with the vapor entering one end of the vessel and exiting at the top of the opposite end (no internal baffling);
- b) vertical drum with the vapor inlet nozzle entering the vessel radially and the outlet nozzle at the top of the vessel's vertical axis; the inlet stream should be baffled to direct the flow downward;
- c) vertical vessel with a tangential nozzle; vertical centrifugal separators differ from vertical settling drums in that the flow enters tangentially and spins around a center tube, which extends below the liquid inlet nozzle; the gas and liquid flow radially downward through the annulus causing liquid droplets to coalesce along the walls and collect in the bottom of the drum; the vapor changes direction once below the center tube and flows upward to the outlet nozzle; to avoid liquid re-entrainment, vapor velocity has to be kept low in the turnaround section of the drum; an additional measure to prevent liquid re-entrainment is a baffle plate below the turnaround section of the drum; the maximum liquid level is the same as vertical settling drums;
- d) horizontal drum with the vapor entering at each end on the horizontal axis and a center outlet;
- e) horizontal drum with the vapor entering in the center and exiting at each end on the horizontal axis;
- f) combination of a vertical drum in the base of the flare stack and a horizontal drum upstream to remove the bulk of the liquid entrained in the vapor.

A split-entry or split-exit configuration can be used to reduce the drum diameter (but increase the length) for large flow rates and should be considered if the vessel diameter exceeds 3.66 m (12 ft). Careful consideration should be given to the hydraulics of split-entry configurations to ensure the flow is indeed split in the desired proportion. Inlet nozzles should include means such as baffles or long sweep elbows to prevent re-entrainment of liquid. Long sweep elbows are typically used up to DN 300 (NPS 12) inlet diameter. Baffles are typically used for larger inlet diameters.

If used, long sweep elbows should be directed away from the outlet location to maximize disengagement by reducing the momentum of the stream and to avoid short-circuiting or "streamlining" flow through the vessel. The long sweep elbow should be located a sufficient distance away from the end of the vessel to mitigate the ricochet of liquid from the end cap. Alternatively, a secondary internal baffle can be installed. Other internal baffles can be required to minimize liquid sloshing. If installed, substantial forces associated with the gas velocities and liquid sloshing should be considered in the baffle mechanical design.

In general, vapor outlet nozzles should not be fitted with any devices (e.g. deflection plates, baffles, demister pads, vane packs, etc.), because of the potential for such devices to fail or plug and obstruct the outlet. Such devices should be used only if the drum is equipped with an alternate outlet nozzle sized for the drum's design vapor flow rate and fitted with a rupture disk (or pin-actuated device) whose burst pressure is selected both to protect the drum against overpressure and to permit proper operation of the drum and relief system in the event the normal vapor outlet becomes obstructed.

The maximum liquid level should not exceed the level where re-entrainment of liquid occurs. Knockout drum facilities typically have level-control instrumentation including local and remote level indication and high and low alarms. Other instrumentation can include pressure indication as well as temperature measurement. One or more pumps are used to remove accumulated liquid from the drum. Depending on the operating philosophy, these pumps typically are started manually with automatic shut-off on low level. The driver for at least one pump should be supplied from a reliable source such as emergency electrical power or steam turbine drive.

Liquid should be removed at a rate sufficiently high to lower the liquid in the knockout drum down to its low liquid level in a time acceptable to the user. The user is cautioned against bringing the facility back online before the liquids in the knockout drum have been removed to this level.

5.7.8.3 Vaporization Facilities

Depending on the climate and the nature of the liquid in the system, winterization and/or some means of supplemental heat input can be required for knockout drums to vaporize any volatile liquids (e.g. liquid propane). However, caution should be exercised in ensuring that material vaporized in the knockout drum does not condense and possibly solidify in the flare header or stack downstream of the knockout drum.

5.7.8.4 Droplet Size Criteria for Flare Drums

The function of the knockout drum is to provide residence time for liquid discharges and to limit the size of droplets directed to the liquid seal drum (if present) or the flare burner. Large liquid droplets and liquid loading can cause smoke, liquid droplets (burning or not burning) to be released from the flare, or mechanical damage.

The phenomenon generally referred to as “burning rain” occurs when a liquid hydrocarbon droplet does not burn completely within the flare flame envelope and the rate of burning is lower than the rate of settling of the liquid droplet. Although the presence of burning rain may result with liquid droplet sizes, conditions, or loadings in excess of the values noted in Items a) through c) below under steady-state conditions, the occurrence of burning rain is often associated with transient flare load conditions where slugs of liquid may be carried over from the flare knockout drum, liquid seal drum, or re-entrainment of liquid accumulated within the flare piping or the flare gas riser. Liquid can accumulate along the pipe walls and low points in flare piping due in part to condensation as well as where flare gas velocities are too low to overcome drag forces of any liquid mist or droplets in the system. Liquid droplets 300 μm and larger may drop out of the gas stream at less than 2 m/s. If liquids are not drained from the system, flare flows with gas velocities exceeding about 3 m/s or 4 m/s can entrain liquid droplets up to 1000 μm in size. Liquid droplets exceeding 1000 μm can readily lead to burning rain regardless of flare type. Burning rain can occur at smaller droplet sizes for some flare types.

Flare burners with smoke suppression technology or those operating at high discharge velocity (i.e. ≥ 0.5 Mach) promote complete combustion of liquid droplets. Flare burners that operate at lower discharge velocity, handle high relative molecular mass liquid components, and/or contain high viscosity liquid droplets will be far less effective at burning liquid droplets. The following is general guidance on droplet size and liquid loadings for several types of flare burners.

- a) Unassisted flare burners—Large liquid droplets cannot be handled smokelessly without smoke-suppression equipment. Burning rain is generally considered possible in an unassisted pipe flare for liquid droplets with a diameter of 600 μm or larger.
- b) Steam-assisted and air-assisted flare burners—Flare gases containing less than 1 % by mass of liquids up to a liquid droplet size of 600 μm can be handled smokelessly and without burning rain. Some air assisted burners with small ports and operated at significant pressures can handle larger amounts, and with larger droplet size, without smoke.
- c) High-pressure (i.e. sonic type) flare burners—If operated at gauge pressures of at least 200 kPa (30 psi), these flare burners can handle flare gases containing 1 % by mass of liquids up to a liquid droplet size of 1000 μm , without smoke.

The flare vendor should be consulted to specify the maximum allowable liquid droplet size and loading specific to their equipment and flaring conditions.

The size of the droplets exiting the flare tip can be different than the droplet size exiting the flare knockout drum or liquid seal drum (if present). However, it is normal practice to assume they are the same. The user may apply other methods to determine the maximum allowable droplet size for their application.

For further information on droplet sizes, see Reference [140].

5.7.8.5 Sizing

Sizing techniques for a horizontal knockout drum are given below. Sizing techniques for a vertical knockout drum are provided in Reference [42]. Sizing a knockout drum is generally a trial-and-error process. The first step is to determine the drum size required for liquid entrainment separation. Liquid particles separate:

- when the residence time of the vapor or gas is equal to or greater than the time required to travel the available vertical height at the dropout velocity of the liquid particles, and
- when the gas velocity is sufficiently low to permit the liquid dropout to fall.

This vertical height is usually taken as the distance from the maximum liquid level. The vertical velocity of the vapor and gas should be low enough to prevent large slugs of liquid from entering the flare.

The dropout velocity ^[136], expressed in m/s (ft/s), of a particle in a stream is calculated using Equation (52):

$$u_c = 1.15 \sqrt{\frac{g \times D(\rho_l - \rho_v)}{\rho_v \times C}} \quad (52)$$

where

g is the acceleration due to gravity [= 9.8 m/s² (32 ft/s²)];

D is the particle diameter, expressed in m (ft);

ρ_l is the density of the liquid at operating conditions, expressed in kg/m³ (lb/ft³);

ρ_v is the density of the vapor at operating conditions, expressed in kg/m³ (lb/ft³);

C is the drag coefficient (see Figure 5).

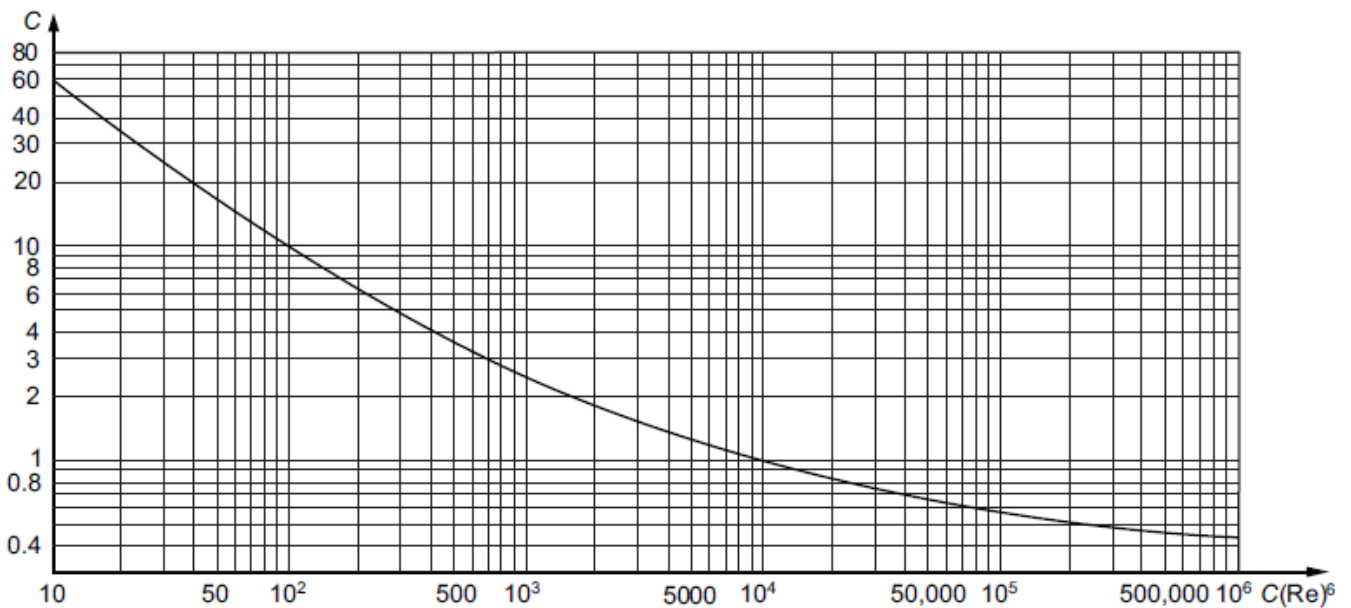

Figure 5—Determination of Drag Coefficient

This basic equation is widely accepted for all forms of entrainment separation.

In SI units:

$$C(\text{Re})^2 = \frac{0.13 \times 10^8 \rho_v D^3 (\rho_l - \rho_v)}{\mu^2} \quad (53)$$

In USC units:

$$C(\text{Re})^2 = \frac{0.95 \times 10^8 \rho_v D^3 (\rho_l - \rho_v)}{\mu^2} \quad (54)$$

where

- μ is the viscosity of the gas, expressed in mPa·s (cP);
- ρ_v is the density of the gas, expressed in kg/m³ (lb/ft³);
- ρ_l is the density of the liquid, expressed in kg/m³ (lb/ft³);
- D is the particle diameter, expressed in m (ft).

NOTE See the section on particle dynamics in *Perry's Chemical Engineers' Handbook* [136].

The second step in sizing a knockout drum is to consider the effect any liquid contained in the drum can have on reducing the volume available for vapor/liquid disengagement. This liquid may result from:

- a) condensate that separates during a vapor release, or
- b) liquid streams that accompany a vapor release.

The liquid holdup capacity of a flare knockout drum is based on consideration of the amount of liquid that can be released during an emergency situation without exceeding the maximum level for the intended degree of liquid disengagement. The holdup times vary between users, but the basic requirement is to provide sufficient volume for a 20 min to 30 min emergency release. Longer holdup times might be required if it takes longer to stop the flow. This holdup should also consider any liquid that can have previously accumulated within the drum that was not pumped out. If there has been a liquid discharge to the knockout drum whereby the liquid level exceeds the maximum level required for adequate vapor-liquid separation, then liquid shall be removed to reduce the level back below this maximum level.

If unit knockout drums are provided upstream of the main flare knockout drum, these upstream drums need not meet the droplet size criteria required at the flare tip because the flare knockout drum shall be designed to do so. However, some credit can be taken for liquid holdup in the upstream drum to achieve the required liquid holdup capacity specified above. If the upstream drum is not designed for the full 20 min to 30 min liquid holdup requirement, then the downstream flare knockout drum shall have any required remaining liquid holdup capacity.

It is important to realize as part of the sizing considerations that the maximum vapor release case might not necessarily coincide with the maximum liquid. Therefore, the knockout drum size should be determined through consideration of both the maximum vapor release case as well as the release case with the maximum amount of liquid. If no valid liquid case exists and the vapor is either condensible or has a condensible component, then the design liquid case should be a minimum of 2 wt % of the maximum gas rate to the flare knockout drum.

An example sizing calculation for a flare knockout drum is given in C.3.

5.7.8.6 Risk of Overfilling Flare Knockout Drum

The risk of overfilling the flare knockout drum shall be assessed. Most flares are not designed to effectively combust liquid. These evaluations should consider the effect of the following:

- a) the amount of liquid in the knockout drum prior to the release including the removal time;
- b) mitigation or prevention of liquid overfill by means of level monitoring (see 5.7.8.7);
- c) the liquid weight on flare header and flare stack mechanical integrity;
- d) the discharge of liquid from the flare (i.e. potential for flame-out, excessive smoke and unburned hydrocarbon emissions, discharge of "burning rain," pool fires around the flare stack, etc.);
- e) the flare siting/location in proximity to areas where people can be exposed, property fence-lines, units, etc.

5.7.8.7 Level Monitoring

During flaring situations, the liquid level in all flare knockout drums should be monitored. High-level alarms should be installed to alert the operators of abnormal knockout conditions. Therefore, these alarms should be set at a relatively low level so there is the required holdup time between the alarm point and the high liquid level for normal facility shutdown. Redundant level transmitters may be considered if high alarm reliability is needed. Minimum levels in knockout drums should be maintained to ensure that sufficient free volume is available in the event of a flaring situation. Level transmitters shall be designed for operation at the minimum design temperature of the knockout drum.

5.7.8.8 Knockout Drums for Oil and Gas Production Facilities

Oil and gas production facilities have producing wells that present an essentially continuous source of high-pressure two-phase hydrocarbons at very high flow rates. This results in relief loads for a blocked outlet of a production separator significantly different from the analogous scenario for a refinery or chemical plant. Sizing a knockout drum to contain 20 min to 30 min of this flow (the sizing basis suggested in 5.7.8.5 for a "typical" facility) is frequently impractical for both transportation to and installation in an oil and gas production facility, whether onshore or offshore. Other methods of disposal of large liquid releases, such as diverting the flow to tankage, are not available and the relieved fluid can only be disposed of via the flare system. Due to these factors, knockout drums for crude oil production facilities are frequently sized using a combination of retention time (to enable instrument and/or operator response) and instrumented response. Instrumentation in crude oil production facilities generally includes independent shutdowns for both the inlet production separators and the knockout drum with the knockout drum instrumentation initiating a facility-wide shutdown. Furthermore, the production separator shutdown is initiated by either high pressure or high level. Thus, the shutdown system on the flare knockout drum [using independent shutdown valve(s)] is an additional layer of protection for preventing knockout drum overfilling.

The SIS on the production separator limits the relief flow to the flare knockout drum, the SIS(s) on the knockout drum will initiate a facility shutdown. If credit is taken for SISs the user shall follow the guidelines in 4.2.6 or alternatively Annex E to ensure that the appropriate reliability and availability is met.

If sufficient risk reduction is achieved compared to the user's risk acceptance criteria by the safety instrumented functions only the knockout drum surge capacity may be based on 1 min to 2 min of continued flow starting once the point is reached where the automatic shutdown is initiated by the flare knockout drum instrumentation. This time considers a conservative estimate of the closure times of the shutdown valves. The flow rate to the knockout drum during this period should consider the full production flow from all producing wells/flow lines. Credit of any reduced flow due to choking in the shutdown valves may be taken.

If isolation of all sources of the relieving fluid from the production separator(s) cannot be assured by the use of safety instrumented functions only, the knockout drum should be designed for a liquid surge time (assuming no pump-out) corresponding to the necessary time for operator intervention. The operator response time needed to take action to stop the release from the production separator, either remotely or manually, plus the stroke time of the

shutdown valves isolating feed to the facility are typically in the range of 3 min to 10 min. These times are dependent on the complexity of the specific installation and how intervention can be achieved (remotely or manually) and shall be evaluated on a case-by-case basis (see 4.2.5). Depending on the reliability of the safety instrumented functions and number of sources that need to be shut-in, the user may take credit for reduced flow due to successful closure of a fraction of the sources (see 4.2.6).

The time for operator intervention should be between the level at which the high-level alarm occurs and the highest liquid level at which the required gas-liquid separation is achieved. The facility-wide shutdown level should occur no higher than the highest liquid level at which the required gas-liquid separation is achieved. The user is cautioned that the facility-wide shutdown trip initiated from high liquid level in the knockout drum should not initiate the emergency depressurization system.

The liquid relief rate should be based on the worst-case liquid scenario. This is typically a blocked outlet scenario on one of the production separators. The user is cautioned that other scenarios may also exist (e.g. blocked liquid outlet of a produced water degasser or failure of rupture disks on the seawater side of coolers) and that the reliability of the shutdown system related to these possible scenarios also needs to be assured related to the associated risk.

The knockout drum should be fitted with a high liquid level alarm (LAH) to alert operations that liquid is at a high level in the drum. It should be recognized that the smaller the volume between the LAH and high-high level shutdown (LSHH), the smaller the drum will be, but the greater the probability that the LSHH will be reached (and the facility will consequently be shut down) before the drum drainage system or operator can intervene. In addition to the emergency case described above, the flare knockout drum should have sufficient surge capacity [e.g. 20 min between the normal level and the high-high liquid level alarm (LAHH)] to avoid spurious trips during normal flaring.

The flare knockout drum shall be designed to prevent liquid entrainment during depressurization system actuation upon reaching the LAHH point in the drum. Regardless of whether credit for operator intervention is accounted for or not, the user needs to specify the knockout drum liquid droplet size separation criterion. Typically, the criteria in 5.7.8.4 can be used as a starting point.

5.7.8.9 Maintenance

Check level instrumentation, including any alarms, low-level pump shutdown instruments, etc., in accordance with vendor recommendations during planned maintenance intervals. The drum level should be checked in the field on a regular basis: field versus any remote level indication. Since knockout drums and liquid seals are typically considered a “dirty” service, routine cleaning of gauge glasses can be required.

There is a potential for the presence of pyrophoric iron in flare system components such as liquid seal drums and, in particular, knockout drums. When any vessel entry is being planned, the potential for the presence of this material should be included in the considerations for safe entry.

5.7.9 Siting Considerations for the Flare

5.7.9.1 Topography

When specifying the location of the flare, it is important to have a detailed plot plan that includes full topography (elevations of land and neighboring land) and elevations of equipment (especially where operators might need to be present, overhead electric lines or control wire runs). The designer needs to know these and other factors in the safe determination of noise, thermal radiation, and consequences of liquid carryover. For example, a flare near a hill or in a valley can be influenced by wind direction and downward turbulence.

5.7.9.2 Dispersion of Gases in Event of Flame-out

To ensure safe operation during periods when the flare might not have a flame present, concentration of hazardous components should be determined using dispersion analyses, assuming the flare is functioning as a vent only. Considerations should be given to not only ground-level locations but also elevated locations where personnel or ignition sources can be located. Other safeguards can be necessary to mitigate exposure hazards. Reliable, continuous pilot monitoring is considered critical when flaring toxic gases.

Dispersion analyses should be performed on flare streams containing toxic, hazardous, or asphyxiating gases that require assist gas to support combustion for the scenario involving loss of assist gas.

See 5.8.10.2 for additional considerations.

5.7.10 Flare Gas Recovery Systems

5.7.10.1 Minimize/Reduce Flaring

Environmental and economic considerations have resulted in the use of flare gas recovery systems to reduce flaring by capturing and either compressing the flare gases for other uses or recycling the flare gases to low-pressure process equipment. Many times the recovered flare gas is treated and routed to the fuel gas system. Depending upon flare gas composition, the recovered gas can have other uses. To comply with this objective, some flaring systems will have to handle both minimum continuous flaring and emergency flaring. The flare system (e.g. flare tip, ignition system, purge gas, etc.) shall be designed to handle the range of flare loads between the minimum continuous flare load and the maximum emergency flare load.

5.7.10.2 Safety Considerations

5.7.10.2.1 Path to Flare

Flare systems are used for both normal process releases and emergency releases. Emergency streams, such as those from PRVs, depressuring systems, etc., shall always have flow paths to the flare available at all times. The design of flare gas recovery systems shall not compromise this path. Several methods of accomplishing this are described in 5.7.10.4.

5.7.10.2.2 Reverse Flow

Because flare gas recovery systems usually involve compressors that take their suction directly from the flare header, the potential for reverse flow of air from the flare into the compressors at low flare gas loads shall be considered. Typically, oxygen content of the flare gas stream should be measured and provisions shall be made to shut down the flare gas compressors if potentially dangerous conditions exist. Design features to reduce the potential for oxygen from entering the compressor include flare stack purging, flare seal vessel design, flare gas oxygen analyzer (with appropriate instrumented or operator response), and low-pressure alarms and trips.

5.7.10.2.3 Flare Gas Characteristics

Flare gases can have widely varying compositions that shall be evaluated during specification of recovery systems. The potential for materials that are not compatible with the flare gas treating systems or ultimate destinations shall be determined. For example, relief streams containing acid gases typically are routed directly to the flare, thereby bypassing the recovery system. Highly inert streams can also be incompatible with recovery systems.

5.7.10.3 Design Considerations

5.7.10.3.1 Sizing

Figure 6 shows a conceptual design for a flare gas recovery system. Typically, the system consists of one or more reciprocating compressors whose suction is directly connected to the flare header. The compressed gas is usually routed to some type of treating system appropriate for the gas composition, then to fuel gas or processing systems.

Flare gas recovery systems are seldom sized for emergency flare loads. Economics usually dictate that capacity be provided for some normal flare rate, above which gas is flared. Flare loads vary widely over time, and the normal rate can represent some average flare load, or a frequently encountered maximum load. Actual loads on these systems vary widely and they shall be designed to operate over a wide range of dynamically changing loads. Flare gas recovery systems often are installed to comply with local regulatory limits on flare operation and, therefore, shall be sized to conform to any such limits.

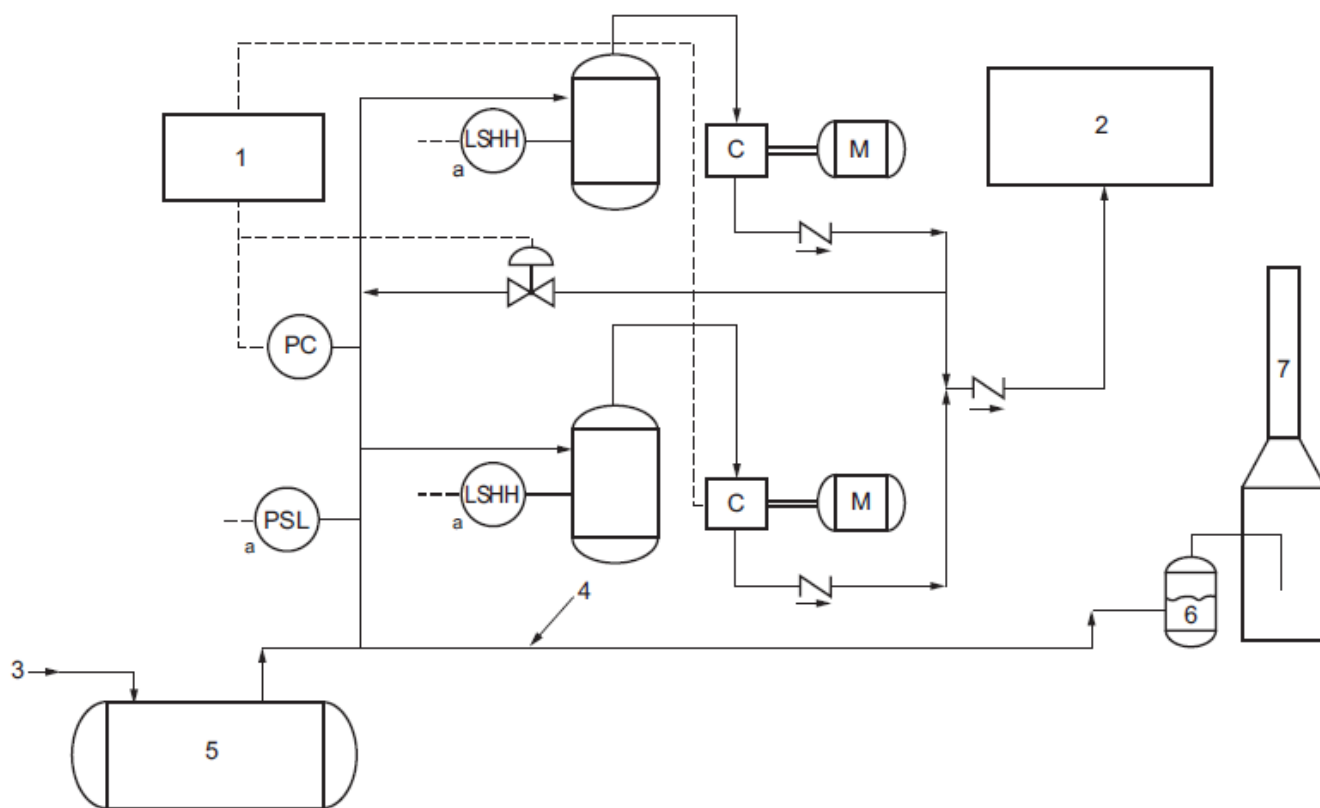

Key

- 1 compressor load control
- 2 flare gas treating
- 3 from process unit flare knockout drums
- 4 flare header
- 5 flare knockout drum (if used)
- 6 water seal
- 7 flare

^a Compressor shutdown.

Figure 6—Typical Flare Gas Recovery System

5.7.10.3.2 Location

Typically, flare gas recovery systems are located on the main flare header downstream of all unit header tie-ins and at a point where header pressure does not vary substantially with load. Locations upstream of process unit tie-ins should be carefully considered because of the potential for reverse flow and high oxygen concentrations. Downstream tie-ins for material not suitable for recovery can be required. Physical location of flare gas recovery equipment should consider maintenance and operation and consider flare radiation hazard zones.

5.7.10.4 Flare Gas Recovery System Flare Tie-in

5.7.10.4.1 General

As discussed in 5.7.10.2, a major consideration in flare gas recovery system design is preservation of a path to the flare for emergency releases. The flare gas recovery system shall be designed as a sidestream from the flare header. Main flare flow should not be through any compressor knockout or suction piping. The tie-in line to the flare gas recovery system should come off the top of the flare line to minimize the possibility of liquid entrance .

Some method of ensuring a positive pressure on the flare gas recovery system shall also be provided. Figure 7 shows some methods of doing this while preserving a reliable open path to the flare.

5.7.10.4.2 Air Ingress Prevention by Seal Drums

The most positive and preferred method for preventing air ingress is the installation of a water seal vessel between the flare knockout drum and the flare itself. The seal provides a relatively constant, low backpressure on the flare header and provides a narrow, but usually adequate, control range for the flare gas recovery control system. The water seal should be designed to function over the pressure for which the flare gas recovery system is designed to operate. At higher release rates, flare gas flows through the seal and out the flare. Design provisions shall be made to maintain the seal level, prevent high flare rates from carrying the seal water up the flare, and prevent seal freeze-up. See Figure D.1 for a typical seal-drum design.

5.7.10.4.3 Air Ingress Prevention by Control Valves with a Relief Device in Parallel

If process requirements are such that the narrow operating ranges afforded by water seals cannot be accepted, an alternate method is to use a control valve to regulate the suction pressure of the flare gas recovery system. A positive path to the flare is provided by installing a low-pressure, high-capacity pilot-operated PRV around the control valve. The sensing line for the PRV pilot shall be provided with a clean gas purge and a backflow preventer.

The sizes of the control and PRVs can become quite large. The flare header system shall also be studied to verify that the backpressure imposed by the PRD (assuming the control valve is closed) at full header load does not induce unacceptable backpressures on devices releasing into the headers at the processing units.

An alternative to the use of a PRV is the installation of nonreclosing devices such as rupture disks or pin-actuated devices. These installations shall also be carefully reviewed to ensure that the devices operate when required to do so, at as low a pressure as possible, and that they do not cause unacceptable backpressure. An analysis should be performed to assure that these requirements are met.

If it is necessary to use a control valve in the flare line to regulate flare gas recovery system suction pressure, the control valve should be interlocked to go fully open upon a higher-than-normal header pressure or when the compressors are unloaded or shutdown. These interlocks are not a substitute for a positive path around the control valve, as described above.

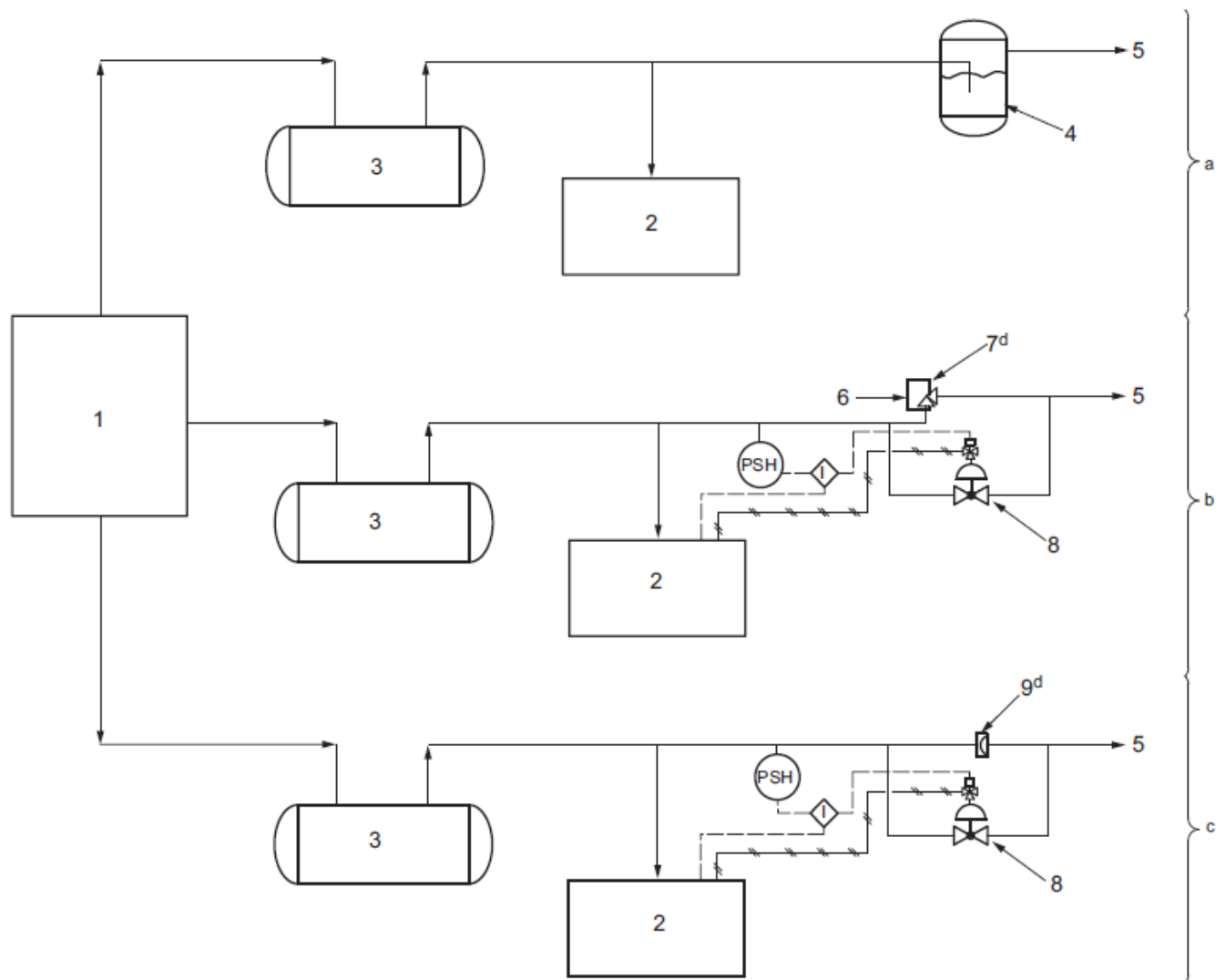

Key

- 1 from process units/flare knockout drums
 - 2 flare gas recovery
 - 3 flare knockout drum
 - 4 seal pot
 - 5 to flare
 - 6 fuel gas purge
 - 7 pilot-operated PRV
 - 8 open valve on high pressure or compressor shutdown/unload
 - 9 rupture disk or other nonreclosing pressure-relief device
- a Preferred system: water seal.
 - b Alternative system 1.
 - c Alternative system 2.
 - d See 5.7.10.4.3.

Figure 7—Flare Gas Recovery Inlet Pressure

5.7.10.4.4 Reverse Flow Protection

Provisions shall be made to prevent reverse flow of air from the flare into the flare gas recovery system in the event that the liquid seal is lost or the fast-opening valve to flare fails open. All compressors should be equipped with a reliable low-suction-pressure shutdown controls. Consideration should also be given to installation of additional instrumentation in the section of header between the flare and the compressor suction take-off to detect reverse flow and automatically shut down the flare gas recovery system.

A flare gas recovery system involving either a liquid seal drum or a fast-opening valve to the flare requires a continuous supply of purge gas be introduced downstream of the liquid seal drum or fast-opening valve to prevent an internal explosion and burn-back.

5.7.10.4.5 Flare Gas Recovery Controls

Flare gas recovery systems operate over wide ranges, usually within very narrow suction pressure bands. A typical system can operate over a suction-pressure range of 0.5 kPa to 1.2 kPa (2 in. H₂O to 5 in. H₂O) to 2.5 kPa to 3 kPa (10 in. H₂O to 12 in. H₂O). The flare gas recovery compressors should be equipped with several stages of unloaders and a compressor-recycle valve. Suction pressure is maintained by pressure control of a recycle valve, with additional loading and unloading of the compressors when limits of valve opening or closing or suction pressure are reached. Usually, the controls are set up to sequentially load and unload the compressors.

5.7.10.4.6 Liquid Impacts

The possibility of significant liquid in flare systems is usually quite high. Liquid-knockout vessels should be provided for the compressors with automatic shutdown of the compressors on high suction drum levels. Other mechanical protection systems can also be required for the compressors. These systems can either shut down or just unload the compressors. See API 618 ^[7] for guidance on compressor protection.

5.8 Disposal to Atmosphere

5.8.1 General

In many situations, PRD vapor streams can be safely discharged directly to the atmosphere if environmental regulations permit such discharges. This has been demonstrated by many years of safe operation with atmospheric releases from properly installed vapor PRDs. Technical work sponsored by API ^[82] has also shown that within the normal operational range of conventional PRDs, well-defined flammable zones can generally be predicted for vapor releases. With proper recognition of the appropriate design parameters, vapor releases to the atmosphere can provide for the highest degree of safety. Where feasible, this arrangement offers significant advantages over alternative methods of disposal because of its inherent simplicity, dependability, and economy. The decision to discharge hydrocarbons or other flammable or hazardous vapors to the atmosphere requires careful attention to ensure that disposal can be accomplished without creating a potential hazard or causing other problems, such as the formation of flammable mixtures at grade level or on elevated structures, exposure of personnel to toxic vapors or corrosive chemicals, ignition of relief streams at the point of emission, excessive noise levels, and air pollution.

5.8.2 Formation of Flammable Mixtures

5.8.2.1 General

The intent of 5.8.2 is to address design issues for individual PRD tail pipes that vent directly to atmosphere.

To evaluate the potential hazards of flammable mixtures that result from atmospheric discharge of hydrocarbons, the physical state of the released material is of primary importance, for example, the behavior of a vapor emission is entirely different from that of a liquid release. Between these two extremes are situations involving liquid-vapor mixtures in which mists or sprays are formed. Vapors, mists, and liquids each introduce special considerations in analyzing the risk associated with atmospheric relief.

5.8.2.2 Vapor Emission

When hydrocarbon-relief streams comprised entirely of vapors are discharged to the atmosphere, mixtures in the flammable range unavoidably occur downstream of the outlet as the vapor mixes with air. Under most circumstances in which individual PRVs discharge vertically upward through their own stacks, this flammable zone is confined to a rather limited definable pattern at elevations above the level of release. At exit velocities from the PRV stack, the jet momentum forces of release usually are dominant^[82]. Under these conditions, the air-entrainment rate is very high, and the released gases are then diluted to below the lower flammable limit before the release passes out of the jet-dominated portion if the Reynolds number, Re , meets the criterion of Equation (55):

$$Re > 1.54 \times 10^4 \left(\frac{\rho_j}{\rho_\infty} \right) \quad (55)$$

where

Re is the Reynolds number at the vent outlet;

ρ_j is the density of the gas at the vent outlet;

ρ_∞ is the density of the air.

NOTE Equation (55) might not be valid where jet velocity is less than about 12 m/s (40 ft/s) or when the jet-to-wind velocity ratio is less than 10.

On the other hand, if the release is at too low a velocity and has too low a Reynolds number, jet entrainment of air is limited, and the released material is wind dominated. Principles of atmospheric dispersion then determine the dilution rate and the distance within which flammable conditions can occur. Under these conditions, flammable mixtures can possibly occur at grade or at distant ignition sources. A complete evaluation requires consideration of the following:

- a) velocity and temperature of the exit gas;
- b) relative molecular mass and quantity of the exit gas;
- c) prevailing meteorological conditions, especially any adverse conditions peculiar to the site;
- d) local topography and the presence of nearby structures;
- e) elevation at which the emission enters the atmosphere.

Previous technical investigations^[142, 161] have demonstrated the rapid dispersion caused by the turbulent mixing that results from dissipation of energy in a high-velocity gas jet. Ricou and Spalding^[142] showed that turbulent mixing with air will dilute the gas jet in accordance with Equation (56):

$$\frac{q_{m,y}}{q_{m,o}} = 0.32 \left(\frac{y}{d} \right) \sqrt{\frac{\rho_\infty}{\rho_j}} \quad (56)$$

where

$q_{m,y}$ is the mass flow rate of the vapor-air mixture at distance, y , from the end of the tail pipe;

$q_{m,o}$ is the mass flow rate of the relief device discharge, expressed in the same units as $q_{m,y}$;

y is the distance along the tail pipe axis at which $q_{m,y}$ is calculated;

d is the tail pipe diameter, expressed in the same units as y ;

ρ_j is the density of the gas at the vent outlet;

ρ_∞ is the density of the air.

Equation (56) applies to all gases including lighter than air (e.g. hydrogen), neutrally buoyant (e.g. air), and heavier than air (e.g. propane). Equation (56) indicates that the distance, y , from the exit point at which typical hydrocarbon relief streams (e.g. propane) are diluted to their lower flammable limit (i.e. a mass fraction of 3 %) occurs approximately 120 diameters from the end of the discharge pipe, measured along the axis. In essence, when hydrocarbon vapors are diluted with air to a mass fraction of approximately 3 %, the concentration of the resultant mixture is at or below the lower flammable limit. This value actually varies from 2.8 % for methane to 3.5 % for hexane. When figured on a volume fraction basis, which is more commonly used than mass fraction to express limits of flammability, these values are equivalent to 5.0 % and 1.2 %, respectively. For materials that do not have combustion characteristics similar to light hydrocarbons, the extent of a flammable mixture can differ considerably from 120 diameters. Based on these dispersion data, it can be concluded that where discharge velocities causing turbulent mixing are achieved, the hazard of flammable concentrations below the level of the discharge point is negligible. Fixed distances may be used for designs based upon experience, which precludes the need to perform dispersion analyses. This confirms the many years of experience with vapor releases from PRVs discharging directly to the atmosphere without accumulating flammable concentrations.

Although a high discharge velocity is characteristic of a PRV when it is flowing at design capacity, one cannot assume that a PRV is flowing at full capacity. For example, even though the initial release can be at a high velocity, once a spring-loaded PRV has opened, kinetic forces are sufficient to offset the spring-closing force until the flow has been reduced to approximately 25 % of the valve's rated capacity. Reduced flow rates can occur as the conditions affecting relief are corrected. In many cases, overpressure can result from a minor operating upset, causing the flow rate to be appreciably less than the design capacity. The probability of these situations occurring can often be minimized by using two or more PRVs and staggering the set pressure to provide for sequential operation. Using a common vent stack for several PRVs can also result in a discharge at a relatively low velocity if only one valve is operating.

Because of these concerns, studies were undertaken at the Battelle Memorial Institute ^[82] to evaluate the effects of reduced velocities of discharge at the point where the PRV is about to reseal at approximately one-quarter of the valve's rated capacity. Also covered in these studies are the effects of the temperature and relative molecular mass of the hydrocarbon gases as they affected the zone of flammability under various ratios of exit velocity to wind velocity. These studies verified that vapors released from PRVs through their individual stacks are safely dispersed even when the valves were operating at only 25 % of their full capacity, which corresponds to the reseal level of the valves. As long as the minimal value given by Equation (55) is exceeded, the release is jet dominated and diluted outside the flammable range, within the jet pattern. For the most part, vent velocities are greater than 30 m/s (100 ft/s), even at the 25 % release rate.

Other studies of the safety of tanker venting ^[132] have shown the same jet momentum dilution effects where release velocities exceed 30 m/s (100 ft/s). One would expect that only for low-set PRVs, or for multiple valves routed via a manifold into a common vent stack, is the Reynolds number of the released gases below the minimum necessary for jet momentum effects.

Figure 8, Figure 9, and Figure 10 demonstrate the limits of flammability vertically, horizontally, and along the main axis of the jet. Hoehne et al. ^[82] indicate that these figures apply to both single and multicomponent hydrocarbon jets of any molecular mixture between methane and heptane. For more detailed analysis, dispersion modeling can be performed. The axial and vertical distances in still air are indicated to be somewhat greater than the 120 diameters indicated by previous still-air studies. However, the horizontal limit of the flammable envelope is shown to be essentially independent of the wind velocity and is significantly lower than the axial distances indicated by the previous study.

The studies demonstrate the adequacy of the general industry practice of locating PRV stacks that discharge to the atmosphere at least 15 m (50 ft) horizontally from any structures or equipment running to a higher elevation than the discharge point. In most cases, this is adequate to prevent flammable vapors from reaching the higher structures. With these jet momentum releases, there should also be no concern about large clouds of flammable vapors or flammable conditions existing at levels below the release level of the stack. These studies have generally verified long-standing experience relative to the safety of vapor releases vertically to the atmosphere from atmospheric PRV discharge stacks.

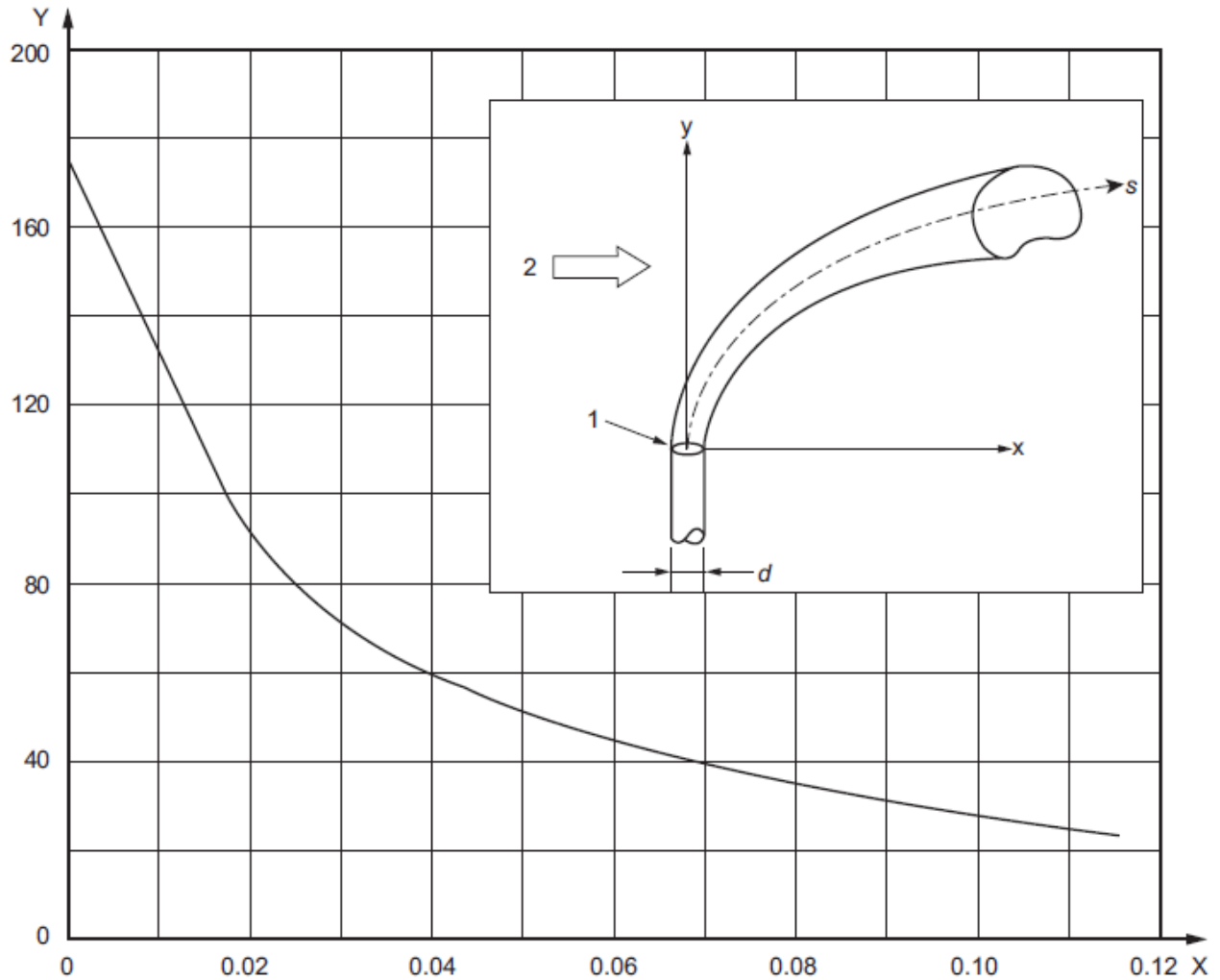

Key

- X velocity ratio, u_{∞}/u_j
- Y vertical plume center distance factor, $y/[(d_j)\sqrt{\rho_j/\rho_{\infty}}]$, dimensionless
- u_{∞} wind speed, expressed in m/s (ft/s)
- u_j jet exit velocity, expressed in m/s (ft/s)
- ρ_j fluid density inside the tip exit, expressed in kg/m³ (lb/ft³)
- ρ_{∞} density of the ambient air, expressed in kg/m³ (lb/ft³)
- d_j inside diameter of the tip (jet exit diameter), expressed in m (ft)
- y vertical distance, expressed in m (ft)

The insert defines the flow system and axes:

- x horizontal distance, expressed in m (ft)
- s distance along the jet center from the tip apex, expressed in m (ft)
- 1 tip of discharge stack
- 2 wind (cross-stream)

The maximum downwind vertical distance from jet exit to lean-flammability concentration limit is the distance factor, Y, multiplied by $[(d_j)\sqrt{\rho_j/\rho_{\infty}}]$, expressed in m (ft)

Figure 8—Maximum Downwind Vertical Distance from Jet Exit to Lean-flammability Concentration Limit for Petroleum Gases

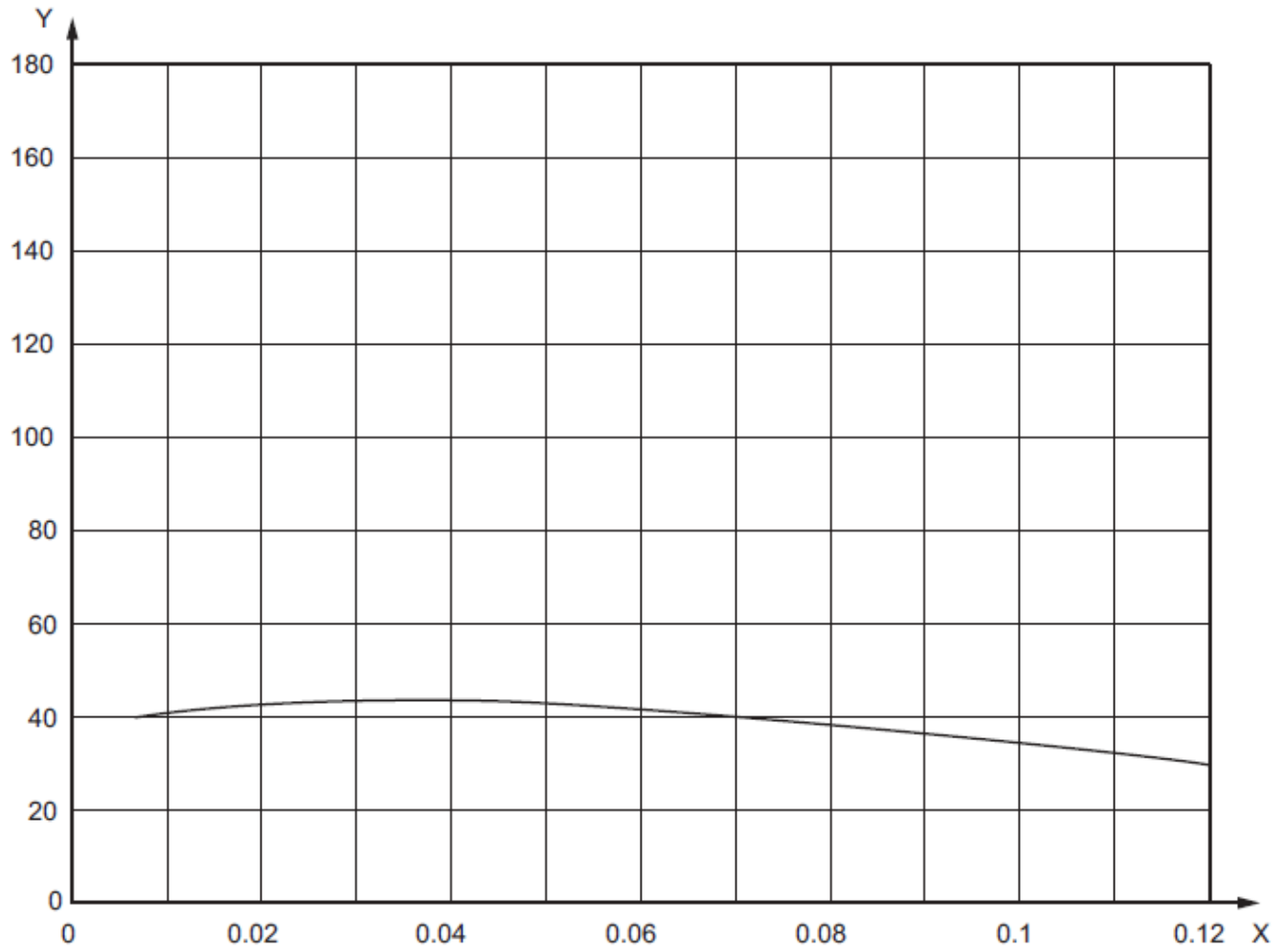

Key

X velocity ratio, u_∞/u_j

Y downwind horizontal plume center distance factor, $x/[(d_j)\sqrt{\rho_j/\rho_\infty}]$, dimensionless

NOTE See Figure 8 for the definition of the other variables and for the flow system and axes.

The maximum downwind horizontal distance from jet exit to lean-flammability concentration limit is the distance factor multiplied by $[(d_j)\sqrt{\rho_j/\rho_\infty}]$, expressed in m (ft).

Figure 9—Maximum Downwind Horizontal Distance from Jet Exit to Lean-flammability Concentration Limit for Petroleum Gases

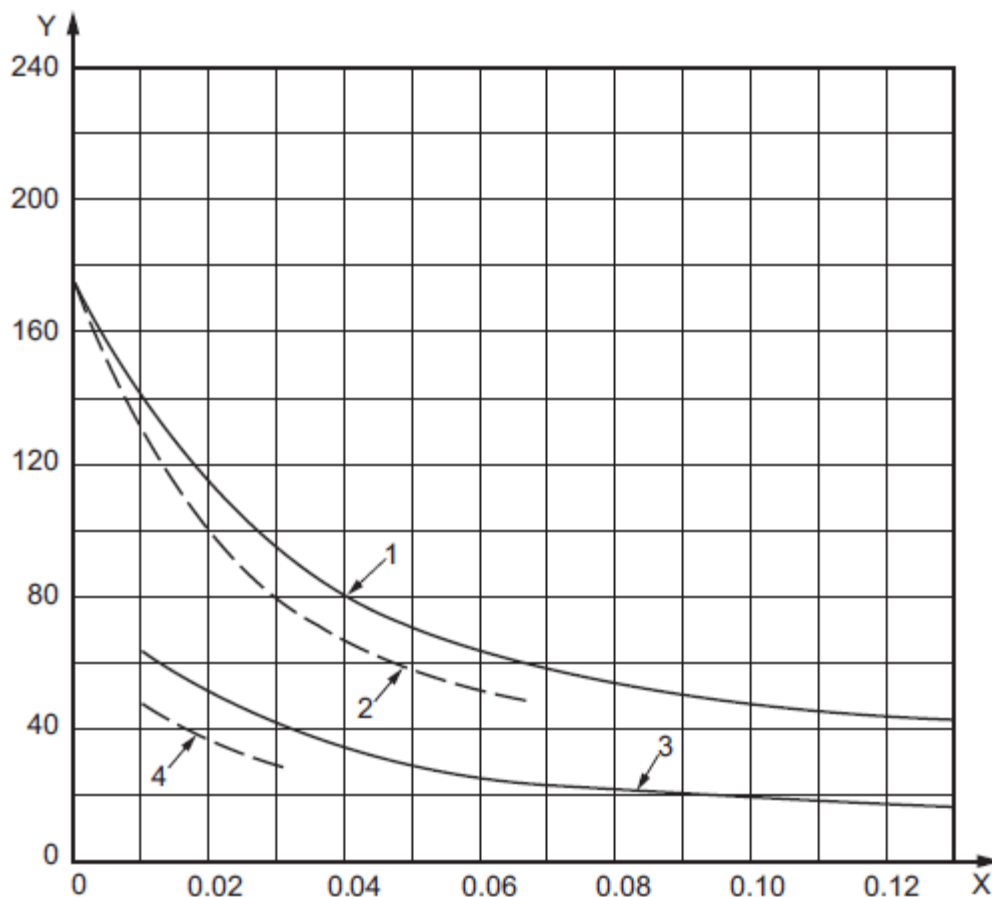

Key

- X velocity ratio, u_{∞}/u_j
 Y downwind horizontal plume center distance factor, $s/[(d_j)\sqrt{\rho_j/\rho_{\infty}}]$, dimensionless
 1 lean limit, cold jet
 2 lean limit, hot jet
 3 rich limit, cold jet
 4 rich limit, hot jet

NOTE See Figure 8 for the definition of the other variables and for the flow system and axes.

The axial distance to lean- and rich-flammability concentration limits is the distance factor multiplied by $[(d_j)\sqrt{\rho_j/\rho_{\infty}}]$, expressed in m (ft).

Figure 10—Axial Distance to Lean- and Rich-flammability Concentration Limits for Petroleum Gases

5.8.2.3 Mist Emission

Mists, as referred to in this standard, result from condensation following vapor relief. Fine sprays associated with relief streams that contain liquids are considered in 5.8.2.4. Condensed mists are finely divided; the diameter of most drops is less than 10 μm , with few larger than 20 μm . Mechanical sprays do not usually contain many drops smaller than 100 μm in diameter.

Whether vapors condense in appreciable quantities when they are released to the atmosphere depends on the stream composition, atmospheric temperature, and exit velocity. The assumption is frequently made that if the lowest anticipated atmospheric temperature is below the dew point of a released hydrocarbon, significant

condensation will occur. This approach ignores two important effects associated with the release of vapors. As vapors are depressurized across the PRV, they are superheated, and the tendency for immediate condensation to occur is minimized in the highly enriched zone at the point of emission. More important is the combined dilution effect of air and light components normally present in discharges from PRVs. Rapid dilution tends to lower the dew point of individual components to a point below the ambient temperature.

Loudon^[111] gives a method of calculating whether condensation of a discharge from a PRV can occur. These calculations indicate that most emissions do not condense, regardless of relative molecular mass, although relatively heavy molecular mass hydrocarbons can condense in the range previously noted (10 μm to 20 μm). This approach is supported by experience with refinery relief installations involving discharge to the atmosphere of vapor streams covering a wide range of conditions.

In cases in which the vapor discharges from PRVs condense, consideration should be given to how this condensation influences the formation of a flammable atmosphere. Combustible liquid mists in air are capable of propagating flame when they are ignited, even though the liquid is so nonvolatile that no appreciable amount of vapor is formed at the ambient temperature. Mists of flammable liquids can thus present a hazard even at temperatures well below their flash point. Burgoyne^[38] has shown that for flammable, condensed mists, the mass percent lower flammability limit and the burning velocity are the same as for the corresponding vapor. According to Saletan^[146], the ignition energy required to ignite a mist in air at ambient temperatures and pressures is approximately 10 times that needed to ignite a vapor.

In cases in which calculations indicate that vapor discharges from PRVs can condense, coalescence can possibly produce droplets that rapidly settle to grade rather than disperse as a mist similar to vapors. The hydrocarbon partial pressure at which the calculated adiabatic air-mixing curve intersects the dew-point curve should be considered indicative of bounding the region in which coalescence seems unlikely. Although no conclusive data are now available, condensation at hydrocarbon partial pressure of 34 kPa (5 psi) or less should be treated as finely divided mists without coalescence. In the absence of coalescence, the effect of gravity should be negligible, since the free-fall velocity of 10 μm hydrocarbon particles in air is approximately 3 mm/s (0.01 ft/s). Therefore, even with very light wind, the discharge from an elevated location travels a considerable distance before it reaches grade.

Based on the foregoing factors pertaining to the dispersion and combustion characteristics of a mist, it can be concluded that as long as the condensate remains in a finely divided form and is airborne, the mixture can be treated for flammability and dispersion characteristics as though it were completely vaporized. Because of the extremely small size of the droplets, use of the methods described in 5.8.2.2 can give an order of magnitude of the concentration at various distances from the point of emission. As noted above, the same mass percentages of hydrocarbons are necessary to make a mist flammable as are necessary to make a vapor flammable. It can, therefore, also be concluded that as long as the minimum Reynolds number of the release is in excess of that required by Equation (55), the envelope of flammability for the mist is within the same confined predictable limits as those for a vapor. Therefore, although condensation can create problems relative to air pollution, if only hydrocarbon-flammability considerations are involved, the risk from an area-explosion potential is no higher than if the vapors had not condensed.

5.8.2.4 Liquid Emission

Unlike discharges composed of vapor or mist, which rapidly disperse when they are vented to the atmosphere at high velocity, liquid discharges settle to grade. If volatile components are present, a flammable atmosphere can result. The risk of fire or explosion can be high if appreciable quantities of liquid hydrocarbons are released to the atmosphere when the ambient temperature is at or above the flash point of the liquid. Theoretically, liquids that have a flash point above the maximum anticipated ambient temperature do not vaporize enough to create a flammable atmosphere. However, widespread spraying of oil droplets can create concern in an emergency and constitute a serious nuisance. Also, fires can occur if the liquid comes in contact with very hot lines or equipment. Therefore, all liquid-relief streams should generally be disposed of by one of the methods described in 5.2.

To minimize the possibility of a release of flammable liquid, all PRVs that vent vapor to the atmosphere should be located so that the valve inlet connects to the vapor space of vessels or lines. In some instances, additional safeguards are warranted. For example, during unit upsets, liquid levels can increase and flood the vessels that are partially or totally filled with vapor during normal operations. The potential for such a situation can be greatly minimized by locating PRVs at a point in the process system where the probability of liquid occurring at the PRV

inlet is considered negligible because of factors related to time and the system's liquid capacity. For example, a PRV located on top of a large fractionating column presents far less risk of liquid release than a valve positioned on the overhead receiver, which can flood in a matter of minutes. In other situations, high-level alarms or other instrumentation can provide a valuable safeguard against high liquid levels reaching the PRV inlet.

In summary, a rigorous analysis should be made of the various causes of overpressure on any system containing flammable liquid in which PRVs that vent to the atmosphere are included in the design. All possibilities that can allow liquid to gain entrance to the PRV should be determined and appropriate safeguards should be taken to prevent this occurrence.

5.8.3 Exposure to Toxic Vapors or Corrosive Chemicals

5.8.3.1 Toxic Vapors

Note that because PRV discharges are noncontinuous, short duration releases, acute toxicity instead of chronic toxicity is addressed by this standard. Nonreclosing relief devices (e.g. rupture disks) discharging to atmosphere can release the entire contents of the protected equipment creating a long-duration, time-varying release thereby requiring special, more sophisticated modeling.

Many toxic vapor streams present little or no acute risk to personnel when they are discharged from PRVs at a remote location. However, certain process streams contain vapors (e.g. hydrogen sulfide) that are harmful at concentrations well below the lowest flammable limits of any hydrocarbon. The design of relief devices vented to the atmosphere shall not expose plant personnel and the public to intolerable risks from toxic vapor discharges. The decision to vent to the atmosphere shall comply with local regulations, this standard, and the user's risk tolerance criteria, whichever is more restrictive.

The dispersion analysis shall use representative values for wind speed, ambient temperature, etc. that are applicable for the site to determine the potential consequences to the public and to personnel working in the plant. Special attention should be given to adjacent elevated structures that can lie within the path of the plume and are thus potentially subject to higher concentrations than at grade. The maximum tolerated concentration is based on exposure duration which may vary. A higher concentration can cause less harm at locations that can be quickly and safely evacuated as opposed to those locations where it is necessary for personnel to remain on duty or where personnel cannot readily leave.

As in the case of a flammable discharge to atmosphere (see 5.8.2.2), a range in flow rates should be considered (e.g. valve's rated capacity, 25 % of rated capacity). Of further importance is the probable duration of a release. The duration of an emergency varies, depending on the process and equipment involved. For example, when the source of overpressure can be eliminated by shutting down a pump or compressor, the duration of relief should be shorter than if a fractionating column were to overpressure. A period of 10 min to 30 min is often sufficient to control most emergency situations.

The user shall either apply the consequence-based approach or risk-based approach as described below. In either approach, the user shall establish acceptance criteria for PRD discharges of toxic vapor to atmosphere.

If applying a consequence-based approach, then the following shall be applied to PRD discharging toxic vapor to atmosphere.

- a) Concentrations of toxic vapors, at the company property line, shall not exceed levels that cause life threatening health effects [e.g. emergency response planning guideline (ERPG)-3 or equivalent]. Note that life-threatening toxicity values vary greatly for different materials. Information on chemical hazard classifications and exposure response acute toxicity values can be found in References [3], [61], and [62].
- b) For personnel inside the plant, the ability to escape is a critical factor in determining the exposure limit. For trained personnel, who have an unobstructed escape route, a higher exposure criterion may be used.

If applying a risk-based approach, then a risk assessment [e.g. layer of protection analysis (LOPA), fault tree analysis, etc.] shall be used to determine the suitability of atmospheric discharge.

If either the consequence-based or risk-based approaches indicate a potential for exposure in excess of the acceptance criteria, then one or more of the following mitigations is recommended. There can be other mitigation measures that would reduce the consequences and/or risk to the acceptable criteria, as follows:

- a) modify the process to eliminate the toxic material;
- b) perform a more rigorous evaluation to better estimate the relief load and/or duration (e.g. perform dynamic analysis);
- c) modify operating conditions to reduce the sizing basis for the PRV (e.g. reduce upstream pressure to reduce relief load, reduce steam pressure to reach a pinch-point on column reboiler);
- d) redesign equipment (e.g. rerate at higher design pressure/MAWP, install a smaller control valve size if control valve failure sets the sizing basis);
- e) route the relief device effluent stream back into the process or to a treatment system (e.g. scrubber, flare);
- f) modify the atmospheric discharge system to improve dispersion (e.g. taller stack, increased discharge velocity from stack);
- g) install an SIS or HIPS to reduce the likelihood of relief discharge.

5.8.3.2 Corrosive Chemicals

Certain chemicals, such as phenols, that are liquid at ambient conditions can create a serious hazard to personnel if they are discharged from PRVs to the atmosphere. When process systems contain such chemicals, atmospheric relief is not safe unless valves can be installed at locations where personnel exposure from release of such materials can be avoided. Many of the same considerations discussed in 5.8.2.4 concerning avoidance of liquid releases apply to corrosive chemicals.

5.8.4 Ignition of a Relief Stream at the Point of Emission

5.8.4.1 General

The possibility of accidental ignition of the outflow of flammable vapors from a PRV or a vent can best be analyzed in terms of the possible causes of ignition covered in 5.8.4.2.1 through 5.8.4.2.4.

The possible existence of outside ignition sources such as open flames, hot surfaces, and unclassified electrical equipment installed in surrounding areas and on structures is known or can be anticipated. With jet momentum releases from PRVs, emission points can be located by dispersion modeling so that the flammable pattern evolved does not reach such sources. This becomes more difficult where wind-dominated, low-velocity releases are involved, since flammable patterns can extend considerable distances from the release point. Also, in these instances, the ignition potential from temporary sources, such as automotive equipment or hot-work activities, should be recognized. With normal atmospheric releases, outside ignition sources can be readily avoided by the proper location of vents. On the other hand, with low-velocity, low-momentum releases, a careful design check should be made of conditions at various emissions rates and atmospheric conditions to avoid the potential of ignition by outside sources. In place of dispersion calculations, fixed distances may be used for designs based upon experience.

5.8.4.2 Sources of Ignition

5.8.4.2.1 Lightning

Discharges from open atmospheric vents have been known to be ignited by lightning. Except for emergency discharges associated with power outages that can occur during thunderstorms, the probability of lightning occurring simultaneously with the opening of a relief valve is negligible. Intermittent discharges over long periods and continuous discharges (e.g. from leaking relief valves) increase the probability of lightning ignition. For additional information about lightning, see the recommendations in NFPA 780 ^[127].

5.8.4.2.2 Electrostatic

For general information on electrostatics, see an article by Eichel^[54] and API 2003^[12]. During high-velocity discharges from gas wells to the atmosphere, static discharges are developed that are sufficient to cause sparks and ignition^[166]. The condensate zone in the jet of well-head gas apparently tends to produce a high level of charge, although ignition does not actually occur. Another theory relating to static ignition proposes that gas flow through a piping system during venting induces a static charge on any solid or liquid particles in the pipe stream that contact the pipe wall. As the gas reaches the sharp edges of the vent outlet, static discharges can occur, either by complete electrical breakdown (spark discharge) or by partial electrical breakdown (corona discharge). There is a lack of documented information on the ignition of PRV vapor discharges attributed to the development of electric potential at the discharge point. The experience of pipeline companies (which customarily discharge natural gas to the atmosphere at low elevations) includes gas gauge pressures as high as 6200 kPa (900 psi) and discharge rates as high as 82 kg/s (650,000 lb/h) from a single vent stack. The probability of ignition by static electricity is, therefore, very low because of a relatively weak charge buildup in the jet and reasonable isolation from the well-grounded vent stack.

5.8.4.2.3 Release of Hydrogen-rich Streams

This conclusion pertains to hydrocarbon vapor releases. Experience indicates that streams with a high hydrogen content are susceptible to ignition by static electricity as a result of the described mechanism because of electrostatic discharges at the sharp edge of the vent outlet. NASA investigated this phenomenon^[123] and found that such electrostatic discharges can be prevented by installing a toroidal ring on the vent stack outlet. This ring inhibits the static discharge at the vent stack exit by removing the sharp-edged geometry of the vent outlet, which is conducive to spark formation.

Ignition of hydrogen from atmospheric vents can also result from the chemical reaction between hydrogen and iron oxides frequently found in vessels and piping. When a stream containing extremely small particles of ferrous oxide (FeO) or iron (Fe) is brought into close contact with the oxygen present in the atmosphere, an exothermic reaction occurs that under ideal conditions can provide sufficient energy to ignite a hydrogen-air mixture. The energy requirement has been experimentally determined at 0.017 mJ (approximately 5 % of that necessary to ignite a methane-air mixture). This quantity of energy can conceivably be imparted to a tiny particle as a result of the heat released in the reaction of either FeO or Fe with oxygen (O₂). Furthermore, if the ratio of surface area to mass were high enough, a temperature sufficient for ignition can be reached. Also, because of the wide explosive range of hydrogen (volume fraction from 4 % to 75 %), flammable atmospheres are formed very close to the point of release. This, along with hydrogen's very low ignition energy, increases the probability of ignition.

5.8.4.2.4 Release of Streams Above the Autoignition Temperature

Relief streams that are above the autoignition temperature on the upstream side of the valve can ignite spontaneously on contact with air unless sufficient cooling occurs before a flammable vapor-air mixture is formed. For this reason, these hot streams should usually be routed to a closed system, cooler, or quench tower. Under some circumstances, with proper location of the discharge stack, ignition can be tolerated. Under these conditions, the thermal radiation effects discussed in 5.8.4.4 should be evaluated. See API 2216^[14] for more information.

5.8.4.3 Explosive Release of Energy

If a quantity of gas accumulates and then ignites, the possible explosive release of energy in the atmosphere can cause concern about using atmospheric relief. Where unconfined jet momentum releases are involved, as with a normal PRD, there is likely to be little potential for the accumulation of large vapor clouds and this can be validated by dispersion and consequence modeling. The total potential hazard can be related to the total quantity of hydrocarbon-air mixture that accumulates within the flammable envelope downstream of the point of emission. With jet momentum releases, the total volume can be calculated. In a typical case, the flammable zone can be in the range of 40 diameters to 120 diameters downstream but can vary depending on densities and ratios of jet-to-wind velocity. The mixture in this zone can contain an average of about 6 % hydrocarbon, which would represent 3 s of the emitted outflow. The volume within the flammable range at any time is relatively small compared with the total gas volume emitted and considerably limits the problem even if an ignition does occur.

If the release rate does not achieve jet momentum and dilution is not achieved, vapor clouds can develop. Similarly, if even a relatively small amount of flammable gas accumulates in a confined or congested space, a significant hazard can be created. In these cases, care should be taken to avoid any confinement of the released gases, since the degree of confinement determines the pressure rise if accidental ignition occurs. Evaluating such confinement should take account of the proximity of buildings or high concentrations of equipment that produce congestion or confinement. The total potential hazard from such sources can then be related to the total quantity of gas released ^[41].

5.8.4.4 Thermal Radiation Effects

Wherever large quantities of flammables are vented, the potential heat release is sufficient to warrant considering its effects on personnel and equipment, even though ignition of the discharge from PRDs is highly improbable. Once allowable thermal radiation levels are established, the required distance from various exposure locations to the point of emission can be calculated (see 5.7.2 for information on evaluating thermal radiation effects).

5.8.5 Excessive Noise Levels

The noise generated by a PRV discharging to the atmosphere can be loud. The noise levels produced by gases at the point of atmospheric discharge can be approximated by reference to 5.8.10.3. Because emergency relief is typically infrequent and of short duration, the noise might not be subject to regulation. In many areas, regulatory authorities define allowable levels of noise exposure for personnel or at property limits. If no regulatory limits are prescribed, the proposed standards of the American Conference of Governmental Industrial Hygienists ^[95] may be applied.

The allowable noise intensity and duration should be evaluated at areas where operating personnel normally work or at property limits. If two or more PRVs can discharge to the atmosphere simultaneously, it is necessary to evaluate the combined effects. For design information on noise levels associated with atmospheric discharge, see 5.8.10.3.

5.8.6 Air Pollution

The continuing problem of air pollution has become a factor that warrants serious consideration. Regulations pertaining to air pollution usually provide exemption for discharges that occur only under emergency conditions; however, effluent concentrations at grade level or other locations obviously should be controlled, even though the acceptance level for limited and occasional emergency discharge can be much higher than that for prolonged or continuous emissions. Methods for calculating the grade-level concentration to determine whether air pollution exists are discussed in the article by Gifford ^[74].

5.8.7 Knockout Drums Venting to Atmosphere

5.8.7.1 General

Atmospheric blowdown systems are knockout drums with stacks open to atmosphere.

If there is a vapor cloud explosion hazard associated with one or more relief cases or discharges, then one of the following shall be used:

- disposal by a flare (see 5.7);
- discharging into a lower-pressure system (see 5.6);
- application of HIPS (see Annex E);
- eliminating the relevant relief cases (redesign of equipment, etc.).

Caution—Not all of these design options are always safer than atmospheric relief for all applications as they may introduce new and different hazards.

Caution—The user shall assess hazards other than a vapor cloud explosion associated with the release and determine appropriate mitigation measures.

The criteria in 5.8.7.2 and 5.8.7.3 can be used to design atmospheric knockout drums for releases that have no vapor cloud explosion hazard.

5.8.7.2 Atmospheric Knockout Drums without Quench Provisions

All of the following criteria shall be met.

- a) The design of the atmospheric knockout drum shall meet the design criteria for flare knockout drums in 5.7.8.
- b) The atmospheric knockout drum shall be designed to knock out liquid droplets such that any remaining droplets or the plume cannot reach working areas, property line, or other critical areas at a hazardous concentration. The droplet size criteria for atmospheric knockout drums should be more stringent than for flare knockout drums (see 5.7.8) because most flares are capable of burning small droplets ^[94].
- c) See 5.8.10 for design guidance on the vent stack.

5.8.7.3 Atmospheric Knockout Drums with Quench Provisions

In 5.8.7.3 is considered the design of the atmospheric knockout drums with a quench provision (e.g. quench drum) where the quench liquid is water that cools and/or condenses the released material. The design of drums where the quench liquid is not water or where quenching nonpetrochemical releases can use the principles given below but can require additional or different considerations.

All of the following criteria shall be met.

- a) The design of the quench drum shall meet the design criteria for flare knockout drums in 5.7.8. In general, a vertical cylindrical vessel is preferred.
- b) The quench drum shall have a liquid-removal system capacity equal to the maximum quench water supply plus condensed and/or liquid hydrocarbons. If backup quench is required, as specified in Item h) below, then the liquid-removal system shall be sized to handle the maximum flow from both sources of quench along with the maximum condensed release flow. No valves shall be provided in the gravity drain line.
- c) If a gravity drain is used, then the quench drum should have a liquid holdup that is sufficient to create the static head necessary to push the liquid out of the gravity drain at the rate required by Item b) above but not reach the bottom of the contactors as shown in Figure D.2.
- d) Water requirements are normally based on reducing gas and liquid outlet temperatures. Selection of the optimum temperature is based on considerations of the temperature and composition of entering streams, the extent to which subsequent condensation of effluent vapors downstream of the drum can be tolerated, and the maximum temperature limitations of the disposal system (e.g. sewer).
- e) The maximum temperature in the quench drum reservoir shall be selected to avoid the drying out of the drum and losing the liquid seal. Some margin shall be provided to stay below the local atmospheric boiling temperature.
- f) The water holdup in the base of the drum shall be sized to absorb the maximum heat of the release for sufficient amount of time for the quench to be fully established.
- g) The water supply shall be reliable. If a fixed basin of water is used, then the basin shall have adequate capacity to supply the maximum condensable quench requirement for 30 min.
- h) The quench water shall be automatically actuated by high temperature or flow in the inlet line. The availability (SIL level) of the quench water system shall be determined (see E.4.2). An emergency backup water connection can be required to achieve the necessary SIL level. Possible consequences from failure of the quench water, resulting in release of excessive vapors to atmosphere and/or hot liquids to the sewer, shall be considered.

- i) A continuous makeup water supply shall be provided to maintain the outlet seal.
- j) The atmospheric knockout drum shall be designed to knock out liquid droplets such that any remaining droplets or the plume cannot reach working areas, property lines, or other critical areas at a hazardous concentration ^[94].
- k) Drum internals to improve vapor-liquid contact should be provided. Scheiman ^[149] covers design criteria for one type of internals frequently used in this service.
- l) The seal height in the liquid-effluent line (assuming 100 % water at the maximum drum liquid temperature) normally is sized for 175 % of the maximum drum operating pressure, or 3 m (10 ft), whichever is greater (see Figure D.2).
- m) Maximum drum operating pressures are typically in the range of 7 kPa to 14 kPa (1 psig to 2 psig). Higher pressures are acceptable providing that maximum allowable PRD backpressures are not exceeded. A higher pressure reduces the size of the off-gas piping but requires a deeper seal leg and can lead to excessive sewer gassing. Steam generated in the condensable blowdown drum due to evaporation of cooling water shall be included in the drum effluent gas stream composition when calculating backpressures.
- n) The quench water system shall be equipped with suitable winterization and freeze protection.
- o) Alarms may be provided to alert operators in the event that design liquid levels are exceeded.

5.8.8 Disposal Through Common Vent Stack

Vent tips and systems are used in some applications due to existing space and other restrictions. Some examples are offshore platforms or backup PRDs on reactors and storage (ethylene plants, ammonia tanks) where normal relief goes to flare but is backed up with a vent. Vent systems are designed to include the following:

- a) knockout drum with level controls, if needed;
- b) stack whose height, location, and configuration considers the potential ignition (immediate and delayed) of the relief gas and dispersion of the vented gas;
- c) ignition source control such as design for electrostatic rings or other countermeasures to reduce possibility of static electric ignition;
- d) noise mitigation [e.g. noise shroud (muffler) or other countermeasures];
- e) vent tip (such as open pipe, sonic tip, or low-pressure dispersive tip) that may employ dispersion enhancement methods such as steam, compressed air, or air blower ring injection at the vent tip.

The general principles in 5.8.1 and 5.8.3 through 5.8.6 also apply to designs involving multiple relief devices discharging into a common header manifold that is either vented directly to atmosphere through a common vent stack or through a separator, quench, blowdown, scrubber, or other drum where liquid is collected and the vapor is discharged through a common vent stack. In particular, the considerations that it is necessary to evaluate for these systems shall include the following:

- a) guidance on determining design loads is given in 5.3;
- b) relief manifold system design is discussed in 5.4.3 and 5.5.2;
- c) guidance on liquid disposal options is given in 4.4.7 and 5.2.

Because these systems can encounter a wide range of relief loads, consequence assessment shall evaluate both the scenarios representing the design loads but also smaller releases that result in a lower discharge velocity and, consequently, a greater tendency for the plume to drop to grade level in a hazardous concentration. Guidance on

the specification and location of the vent stack is given in 5.8.10. Note that the guidance in 5.8.2 applies only to individual relief device tail pipes that discharge to atmosphere.

If there is a vapor cloud explosion hazard associated with one or more relief cases or discharges, then one of the following shall be used:

- a) disposal by a flare (see 5.7);
- b) discharging into a lower-pressure system (see 5.6);
- c) application of HIPS (see Annex E);
- d) eliminating the relevant relief cases (redesign of equipment, etc.).

Caution—Not all of these design options are always safer than atmospheric relief for all applications as they may introduce new and different hazards.

Caution—The user shall assess hazards other than a vapor cloud explosion associated with the release and determine appropriate mitigation measures.

5.8.9 Sewer

Nonvolatile liquid discharges from PRDs may be piped to sewer drains, provided that the sewer system has adequate capacity and is properly sealed and vented. Caution should be exercised to avoid discharging volatile, toxic, or hot fluids into a sewer.

5.8.10 Vent Stacks

5.8.10.1 Sizing

Where the atmospheric vent handles combustible vapors, the outlet from the vent should be elevated approximately 3 m (10 ft) above any adjacent equipment, building, chimney, or other structure (see 5.8.1 through 5.8.8 for additional discussion). Provisions should be made for drainage of each vent pipe so that liquid cannot accumulate in the vent.

The size of a vent stack is determined by the available pressure drop and by any minimum velocity required to prevent hazardous conditions due to combustible or toxic material at grade or working levels. Calculation methods applicable to a vent stack that discharges hazardous materials are given in 5.8.2.2. Normally, a size is selected that results in a high discharge velocity; for example, a velocity of 150 m/s (500 ft/s) provides excellent dispersion. The size should be checked to ensure that sonic flow is not established or, if it is, that allowance has been made for the pressure discontinuity at the discharge end in calculating pressure drop. The pressure drop across the vent stack shall be included in the calculation of the total backpressure on relief devices flowing into the header network. See 5.5.2 for more details.

A sample calculation is given in C.4.

5.8.10.2 Design Details

The principles in 5.8.1 through 5.8.8 shall be used when selecting the vent stack height and location. The siting of vent stacks discharging to atmosphere should consider personnel health and safety, noise, potential odor, potential ground level concentrations, potential liquid carryover, ignition sources, and thermal radiation. Dispersion modeling, consequence analysis, and/or risk analysis are valuable tools for evaluating whether vapors discharged from the vent stack pose flammable, toxic, or other hazards to personnel. These systems often handle a wide range of relief loads. The dispersion analyses and consequence assessments shall evaluate the range of conditions (flow rate, composition, temperature, etc.) that the stack is expected to handle.

NOTE Smaller releases result in a lower discharge velocity causing a tendency for the plume to drop to grade level in a hazardous concentration.

The height and location of the vent stack shall be selected so that the concentration of vapor at a point of interest is below the lower flammable limit of the vapor. The lower threshold for flammability concerns can be satisfied by ensuring that the concentration at potential sources of ignition, personnel location, or other vulnerable areas does not exceed 0.1 times to 0.5 times the lower flammable limit. Electrostatic ignition of atmospheric releases is discussed in 5.8.4.2.2. In any case, the radiant heat intensity for vent stacks shall be evaluated for an ignitable vapor. This shall be done by the same means as used for flare stacks, and the same limits of radiant heat intensity shall apply. Radiant heat levels rather than dispersion can sometimes govern the vent stack design in determining stack height.

Toxic thresholds are generally much lower than the flammability thresholds in certain applications and can become the governing factor.

If dispersion and consequence analyses indicate that flammable or toxic or radiant heat levels can be exceeded, it is necessary that the design be improved. Design options include, but are not limited to, elimination of relevant relief cases (via HIPS, redesign of equipment, etc.), removal of relevant relief devices from the vent system, or elimination of the vent system (e.g. connection to a flare).

The potential for flashback shall be considered. An example of a method to mitigate flashback is to install an appropriate and reliable continuous purge gas at a rate determined by the Husa correlation to prevent air intrusion (see API 537). Steam is not an effective purge fluid for preventing air infiltration because it can condense.

See 5.7.9.1 for topographical considerations.

In every vent stack installation, careful consideration should be given to two potential problems:

- a) accumulation of liquid in lines that terminate at the vent stack;
- b) accidental ignition of the released vapor by lightning.

Accumulation of liquid in lines to the vent stack can result from leakage into the system of high relative molecular mass vapors that condense at ambient temperature. If appreciable quantities of liquid collect, they will subsequently be discharged to the atmosphere when vapors are released into the system.

To avoid liquid accumulation, pockets should be prevented from occurring in the lines and the system should be sloped to a low-point drain. These drains can be installed to function automatically by using a properly designed seal. The height of the seal should provide a head equivalent to at least 1.75 times the backpressure under the maximum relief load to avoid release of vapor through the seal. As an alternative to a sealed drain, a small disengaging drum may be installed at the base of the vent stack. This type of installation is recommended where significant quantities of liquid can occur.

The possibility that vapors from the vent stack can be accidentally ignited by lightning or other sources usually makes a remote-controlled snuffing-steam connection desirable on the vent stack. This is especially true in locations where the incidence of lightning is high or where access to the point of discharge is difficult with conventional fire-extinguishing equipment. It is frequently impractical to size the steam-supply line for a rate that is sufficient to extinguish a fire under maximum venting conditions. However, steam is still essential, since, in most cases, vent fires occur when the only flow to the system consists of leakage or minor venting. Furthermore, unless steam is supplied, if ignition occurs when venting at or near the maximum design load, the fire will likely continue to burn when the cause of overpressure is corrected, with an accompanying reduction in venting.

5.8.10.3 Noise

5.8.10.3.1 Calculation of Noise Level

The sound pressure level (i.e. noise level) at 30 m (100 ft) from the point of discharge to the atmosphere can be approximated by Equation (57):

$$L_{30(100)} = L + 10 \lg(0.5 q_m \times c^2) \quad (57)$$

where

$L_{30(100)}$ is the sound pressure level at 30 m (100 ft) from the point of discharge, expressed in dB;

\lg is logarithm base 10;

L is the sound pressure level from Figure 11, expressed in dB;

q_m is the mass flow through the valve, expressed in kg/s (lb/s);

c is the speed of sound in the gas at the valve, expressed in m/s (ft/s).

Figure 11 ^[73] illustrates the noise intensity measured as the sound pressure level at 30 m (100 ft) from the stack tip versus the pressure ratio across the PRV.

Equation (58) and Equation (59) show how to calculate the speed of sound, c .

In SI units:

$$c = 91.2 \left(\frac{k \times T}{M} \right)^{0.5} \text{ m/s} \quad (58)$$

In USC units:

$$c = 223 \left(\frac{k \times T}{M} \right)^{0.5} \text{ ft/s} \quad (59)$$

where

k is the ratio of the specific heats in the gas, dimensionless;

M is the relative molecular mass of the gas;

T is the gas temperature, expressed in K (°R).

C.5 contains examples of noise calculation in SI and USC units.

5.8.10.3.2 Adjustment for Distance

The above calculations are based on spherical spreading of the sound. If distances much larger than the height of the vent aboveground are of concern, add 3 dB to the calculated result to correct for hemispherical diffusion.

By applying Equation (60) and Equation (61), the noise level can be adjusted for distances that differ from the 30 m (100 ft) reference boundary.

In SI units:

$$L_p = L_{30} - [20 \lg(r/30)] \quad (60)$$

In USC units:

$$L_p = L_{100} - [20 \lg(r/100)] \quad (61)$$

where

L_p is the sound pressure level at distance r , expressed in dB;

L_{30} is the sound pressure level at 30 m, expressed in dB;

L_{100} is the sound pressure level at 100 ft, expressed in dB;

r is the distance from the sound source (stack tip), expressed in m (ft).

For distances greater than 305 m (1000 ft), some credit may be taken for molecular noise absorption. If PRVs prove to be excessively noisy during operation, the sound can be deadened by the application of insulation around the valve body and the downstream pipe up to approximately 5 pipe diameters from the valve.

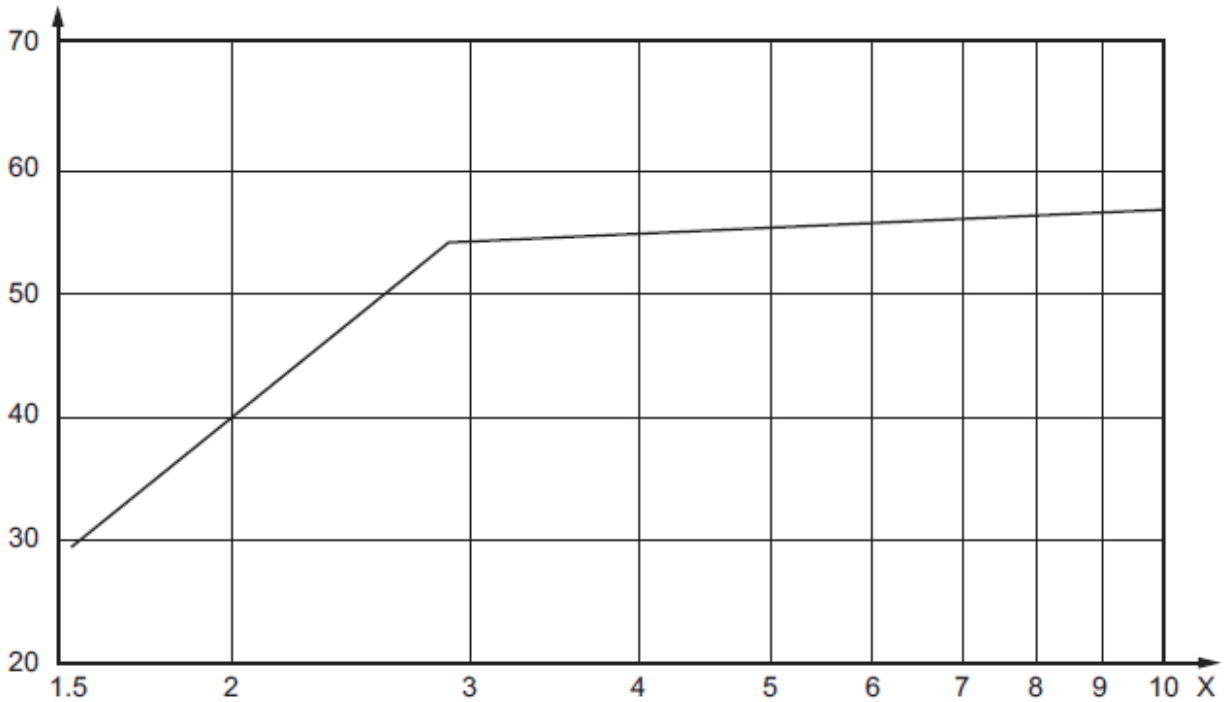

Key

X pressure ratio, PR

Y sound pressure level, $L = L_{30(100)} - 10 \lg(0.5q_m \cdot c^2)$, decibels

NOTE PR is the pressure ratio and is defined as the absolute static pressure upstream from the restriction (e.g. pressure-relief valve nozzle) divided by the absolute pressure downstream of the restriction while relieving. In the case of calculations involving pressure-relief devices, the upstream pressure is the inlet pressure to the pressure-relief device during the relieving event. The downstream pressure should use atmospheric pressure when venting to atmosphere. In some cases, critical flow can occur not only in the pressure-relief valve nozzle but also at the discharge pipe outlet to atmosphere. In this case, the noise level is additive (logarithmic). In the case of the discharge pipe, the pressure ratio is the absolute pressure within the pipe at the outlet divided by atmospheric pressure.

Figure 11—Sound Pressure Level at 30 m (100 ft) from the Stack Tip

5.9 Design Details for Seal and Knockout Drums

A convenient way to state the detailed design requirements for a seal drum and a knockout drum is to use datasheets from API 537.

Design details that can be applicable to knockout drums and seal drums include the following.

- a) Antiswirl or antivortex baffles should be used on the liquid outlet lines.
- b) Internally extended liquid outlet nozzles should be used so that sediment settles out in the drums, not in low spots in the lines.
- c) Antifreeze, siphon-type drains should be used for normal manual drains if a freezing problem exists.
- d) Provisions should be made for water leg or boot and water removal if three-phase separation is expected.
- e) Handholes [DN 100 to DN 200 (NPS 4 to NPS 8) nozzles] should be present on the bottom of the drum to permit thorough cleaning. These nozzles should have DN 40 (NPS 1 1/2) or DN 50 (NPS 2) valves in the blind flange to permit complete draining of the vessels before opening.
- f) Allowance should be made for blinding, venting, purging (steaming), and preparing the vessel for entry where manways are provided.
- g) Provisions should be made for heating the contents of the vessel if cold weather, autorefrigeration, viscous or congealing liquids can introduce problems. If internal coils are needed, consideration should be given to coil drainage. The coils should have a generous corrosion allowance and adequate support to prevent mechanical failure. Because one side of the vessel shell cannot be inspected, heating jackets that use the vessel shell as one wall should be avoided.
- h) If a demister pad or other liquid extraction device is used, then a properly designed by-pass around the device shall be installed to ensure an open path to the flare.
- i) The pressure drop across either sonic or subsonic flare tips, the piping between the tip and the flare knockout drum and staging valve (when present) shall be considered when specifying the flare knockout drum design pressure. A minimum design gauge pressure of 345 kPa (50 psi) is suggested for knockout drums where appropriate precautions are taken to ensure that the oxygen concentration is maintained below that required to support combustion. NFPA 69 provides guidance on designing vessels for deflagration pressure containment and explosion prevention systems^[126]. See 5.5.2 for effects of backpressure on PRDs.
- j) Liquid seal in sonic flare application should be used with caution and with adequate measures taken to either prevent liquid from being blown out of the liquid seal drum or ensure the downstream system can handle the liquid slug impacts. Note that flashback across a sonic flare tip while operating at sonic velocity is unlikely.
- k) In designing vessel nozzles, attachments, supports, and internals, one should consider shock loadings that result from thermal effects, slugs of liquid or gas expansion.
- l) Try cocks for liquid-level detection can be desirable in addition to or instead of level gauges.
- m) Facilities to provide for continuous removal or intermittent manual skimming of hydrocarbons that can accumulate should be considered. Constant skimming by means of continuous addition of seal liquid and overflow to drain can be used. Provisions for periodically raising the level of the seal liquid to force lighter fluid out through a skimmer connection are permissible. The designer is cautioned to review the proposed system to ensure that lighter material cannot build up to the point at which a false (nondesign) sealing effect is established.
- n) Instrumentation components should be the simplest and most rugged available and should be easily maintained (externally mounted and valved). The use of seals instead of valves and of valves instead of traps is

preferred, primarily because of the nature of the materials handled and the conditions under which it is necessary that these components operate. On-off valves with large flow areas are frequently preferred to small-passage throttling valves.

- o) Provisions for establishing and maintaining an adequate seal level are recommended.
- p) If corrosion can occur at the seal fluid/vapor interface, an adequate corrosion allowance should be used. Such corrosion can occur even in hydrocarbon systems that use water as the seal fluid or in areas where water can collect at low points in the system.

In addition to these common details, some details are specific to the various types of equipment. Knockout drums can be of the horizontal or vertical type; and they should be provided with a pump or draining facilities and instrumentation to remove the accumulated liquids to a tank, sewer or other location. The actual type of disposal used depends on the characteristics and hazards associated with the liquids removed. The design of liquid-removal facilities for a knockout drum depends on the size of the vessel and the extent or probability of liquid occurring in the system.

In the simplest system, the vessel might have only a manually operated drain valve and a liquid-level sight glass for reference. A liquid-removal pump is frequently used on knockout drums. Knockout-drum transfer pumps are sized for a minimum net positive suction head requirement. Their specification should also consider the maximum liquid temperature that can be encountered.

A high-level alarm, a manual starting switch, and an automatic shutoff switch to the pump motor are generally provided. More elaborate arrangements can also have high- and low-level alarms and level controls that operate a motorized drain valve or a liquid-removal pump. Where a drain valve is used, the on-off type is more common; however, a throttling type may be employed. The high liquid level in the drum is limited so that the cross-sectional area of vapor passage is not reduced. The low liquid limit is established to prevent vapor from entering the liquid removal system.

The seal drum should be located between the stack and the other header drums and as close to the flare stack as is practical. A variation of a seal drum is often incorporated into the base of the flare stack where the flare line enters the stack. The configuration of a seal drum may consist of a vessel partially filled with a sealing liquid (e.g. water).

The problem of surging in seal drums can be minimized by the use of slots or V-notches on the end of the dip pipe so that increasing flow area is provided as the gas flow increases, utilizing a principle similar to that involved in the design of a bubble cap. Occasionally, it can be desirable to increase the size of the inlet line inside the drum to reduce gas velocity and allow enough circumference for the slots. The desired sealing level may also be maintained by means of an automatic controller operating on the liquid supply line. Low- and high-level alarms are sometimes used for warning in case the liquid is not maintained within the desired levels. An adequately sized drain line with shutoff valves should be provided for removing the liquid.

Annex A (informative)

An Analytical Methodology for Fire Evaluations

A.1 Nature of a Fire

A fire will have a range of different fuel-to-air proportions at various locations within the flame volume as illustrated by the solid line in Figure A.1. At a stoichiometric air/fuel ratio < 1 , the combustion is controlled by the air supply (i.e. fire is ventilation controlled). At a stoichiometric air/fuel ratio > 1 , there is excess air so the combustion is controlled by the available fuel (i.e. fire is fuel controlled).

For example, the available fuel is much larger than the available air at the surface of a pool fire where the fire is therefore ventilation controlled. As one moves vertically from the pool surface, available air increases resulting in an increase in the fire heat flux as the stoichiometric ratio trends toward 1. At some locations inside the flame volume, the stoichiometric air/fuel ratio would equal 1, which corresponds to peak fluxes. Moving toward the border of the flame volume, air is in excess so the fire heat flux would decrease. Averaged over the entire total flame volume, the available air is typically much larger than the available fuel. Note that the heat flux level is dependent on many factors including size of the fire, type of fuel, reradiation from the surroundings, etc.

This profile also changes with time for a specific location or point within the fire. The dashed line in Figure A.1 represents averaged heat fluxes (local peak and surface averaged) for the entire flame volume. The local peak heat flux is averaged because the maximum peak heat flux for a given location in the flame is rapidly changing with time. The use of an average heat flux is suggested as an adequate method for engineering purposes. Detailed descriptions of the nature of fires (open and confined, pool fire and jet fire) are given in References [56] and [144].

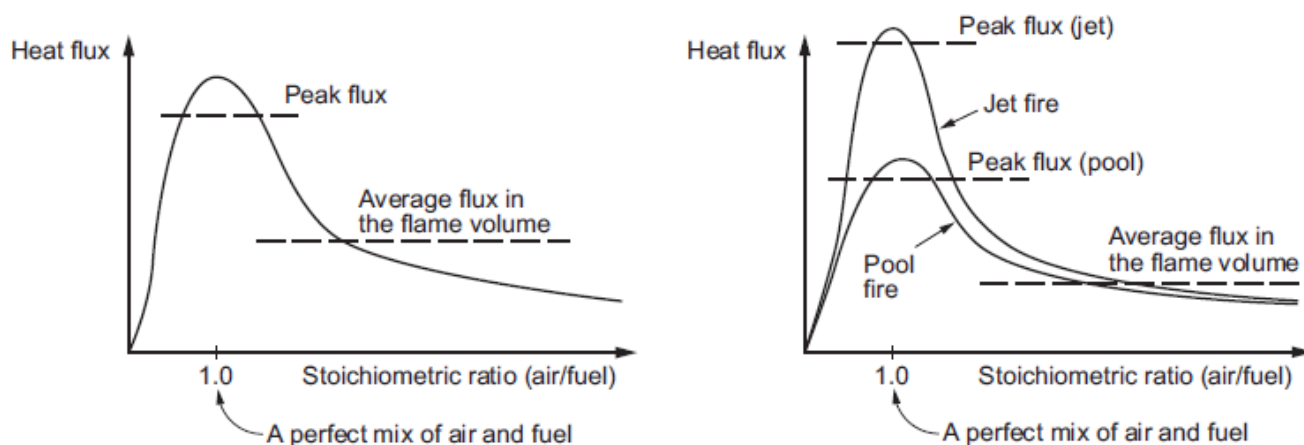

Figure A.1—Effect of Fuel Air Stoichiometry on Pool and Jet Fire Heat Fluxes

A.2 Background of the Empirical Method in 4.4.13.2.4.2

The problem of estimating fire-relief requirements for storage tanks was first recognized in 1928 when the NFPA requested API to recommend that a table of minimum emergency relief loads for a series of tank capacities be included in NFPA's *Suggested Ordinance Regulating the Use, Handling, Storage, and Sale of Flammable Liquids and the Products Thereof*.

It was later recognized that tank capacities did not provide the best basis for estimating the amount of vapor to be handled. Because the vessel absorbed heat transmitted almost entirely by thermal radiation, the area exposed, not the volume of the tank contents, seemed to be the important factor. Many of the tanks were large and were never expected to be entirely surrounded by fire; the assumption was, therefore, made that the larger the area of the

container, the less the likelihood that the tank would be fully exposed to radiation. In other words, the larger the surface area of the tank shells, the lower the average unit heat absorption rate from a fire.

By 1948, several different equations ^[159] were in general use, prompting the API Subcommittee on Pressure-Relieving Systems to develop an equation for determining the heat absorbed from open fires using the test data available at the time. The resultant equation has remained in general use since its publication in 1955 ^[6], and its development is documented in a paper presented by Heller in 1983 ^[80].

Table A.1 contains data from 10 fire tests and one actual fire. These data result from tests in which means were provided to measure the total heat absorbed by a vessel by:

- a) computing the heat required to bring the liquid contents to the boiling range, and
- b) measuring the amount of liquid contents evaporated in a given time.

The unit heat absorption rates in Table A.1 are average rates on the wetted surface.

Examinations of detailed reports on these tests indicate that the setup for tests 4, 5, and 8 was arranged to provide continuous and complete flame envelopment of the small vessels; under these conditions, maximum average heat input rates of 96 kW/m² to 100 kW/m² (30,400 Btu/h·ft² to 32,500 Btu/h·ft²) were realized. The environmental conditions set up for tests 1, 3, 6, 7, 9, and 10 allowed the flame to be subjected to air currents and wind. All other factors were conducive to maintaining maximum heat input, a condition that is not likely to exist in a refinery. Under these conditions, the maximum average heat input rates varied greatly. Test 2 differed from test 1 in that drainage away from the equipment was provided. The maximum heat input rate is reduced by 60 % when drainage is provided; this fact was incorporated into the development of Equation (7) and Equation (8). Test 11 gives an indication of the effect of a large area on average heat input during an actual fire.

The test reports mentioned that in some cases the tests were delayed until the arrival of a calm day so that the wind would not blow the flames away from the vessel. Copious supplies of fuel were available. In most cases, the fuel was maintained by dikes in a pool beneath the vessel and was not allowed to drain away as it normally would. In the Rubber Reserve Corporation tests ^[143], a 5 cm (2 in.) gasoline line, running full, was required to keep the fuel supplied during the test. Without these special adverse conditions, the maximum heat absorption values obtained by these tests are extremely unlikely to occur in an actual refinery fire.

Since the Rubber Reserve Corporation tests, there were two large-scale pool fire tests conducted in which a vessel containing LPG was exposed to a pool fire ^[29, 32, 112]. The test data generally validate the observations obtained in the Rubber Reserve tests and confirm the applicability of Equation (7) and Equation (8) in most cases. Exceptions are for certain types of confined fires where higher absorbed heat fluxes are possible. The tests are described in C.6, which also provides a comparison with the API empirical method and an alternative analytical method described below.

A.3 Alternative Analytical Method

A.3.1 General

The empirical method given in 4.4.13 assumes typical in-plant conditions for facilities within the scope of this standard. The empirical method is recommended to calculate the size of PRDs for fuel-controlled pool fires involving hydrocarbons. It can also be used to calculate the pressure profile (pressure versus time) for vessels, piping, and other equipment exposed to fuel-controlled pool fire. An analytical method for fire modeling is detailed below ^[56, 144, 148]. The analytical method can be used as an alternative to the empirical method for calculation of the size of PRDs and the pressure profile, both of which involve the surface average heat flux. The analytical method can also be used to calculate the wall heat-up that involves the local peak heat flux and to evaluate fires where the empirical method does not apply (e.g. jet fires).

Table A.1—Comparison of Heat Absorption Rates in Fire Tests

Test	Source	Type of Exposure	Fuel	Vessel Capacity		Total Area		Wetted Area		Total Heat Input		Temperature of Surface		Heat Input per Unit Wetted Area		Ref. ^b
				m ³	(BBL) ^a	m ²	(ft ²)	m ²	(ft ²)	kW	(Btu/h)	°C	(°F)	kW/m ²	(Btu/h·ft ²)	
1	H.C. Hottel, average of 36 tests	6 in. thick metal stack	Gasoline	Conning tower		27	(296)	11	(123)	1100	(3,760,000)	—	—	96	(30,500)	[83]
2	H.C. Hottel, average of 13 tests	6 in. thick metal stack	Gasoline	Conning tower		27	(296)	11	(123)	630	(2,139,000)	—	—	55	(17,400)	[84]
3	Standard Oil Company of California	Heating water in drum	Naphtha	0.41	(2.6)	—	—	2.4	(26)	120	(416,000)	—	—	50	(16,000)	[114]
4	Standard Oil Company of California	Heating water in tank	Naphtha	5.2	(33)	19	(206)	9.8	(105)	990	(3,370,000)	21 to 100	(70 to 212)	100	(32,000)	[114]
5	Underwriters Laboratories, Inc.	Water flowing over plate	Gasoline	—	—	2.2	(24)	2.2	(24)	230	(780,000)	24	(76)	100	(32,500)	[162]
6	Rubber Reserve Corporation test No. 17	Heating water in tank	Gasoline	18.9	(119)	37	(568)	37	(400)	2700	(9,280,000)	150	(300)	73	(23,200)	[143]
7	Rubber Reserve Corporation test No. 17	Generating steam in tank	Gasoline	31.6	(199)	53	(568)	37	(400)	2500	(8,400,000)	—	—	66	(21,000)	[143]
8	Rubber Reserve Corporation test No. 17	Water flowing in 3/4 in. standard pipe	Gasoline	—	—	0.84	(9.0)	0.8	(9.0)	80	(274,000)	—	—	96	(30,400)	[143]
9	API project test No. 1	Heating water in tank	Kerosene	0.14	(0.88)	1.5	(16.2)	0.6	(6.1)	28	(95,800)	150	(300)	50	(15,700)	[163]
10	API project test No. 2	Heating water in tank	Kerosene	0.14	(0.88)	1.5	(16.2)	0.6	(6.1)	30	(102,500)	160	(320)	53	(16,800)	[163]
11 ^c	Report to API on 38-ft butane sphere	Plant fire	Butane	800	(5000)	400	(4363)	400	(4363)	6900	(23,560,000)	—	—	17	(5400)	[30]

^a BBL = barrels.
^b Bibliographic item number.
^c This represents an actual fire.

It is important to note that the fundamental basis of the empirical and the analytical methods are different; therefore, different results can be obtained using the two methods. The empirical method is based on pool fire tests involving typical hydrocarbons under conditions expected in a refinery environment. An empirical expression was derived from the test data whereby the only variables are the wetted surface area of the equipment, adequacy of drainage, and presence of insulation. In contrast, the analytical method is based on heat transfer calculations that require specification of a number of variables that characterize details of the fire and heat transfer characteristics (e.g. fire temperature, emissivities, heat transfer coefficient, etc.). Because the range in these variables can vary significantly, a wide range in fire heat inputs can be obtained. Hence, it is important to understand the basis of the variables and ensure the selected values for the variables are representative of the fire scenario being evaluated (e.g. be careful when using data from different fire tests).

Guidance on the selection of appropriate values for the variables is given below. Examples involving the use of the analytical method to reproduce fire test data are given in C.6. A comparison of the analytical method and the empirical method (4.4.13) is given in C.6.5.

A.3.2 Heat Absorbed from Fire

Equation (A.1) can be used to estimate the absorbed heat flux in W/m^2 ($\text{Btu/h}\cdot\text{ft}^2$) for surfaces exposed to fire. Equation (A.1) is valid for open pool fires, confined pool fires, and jet fires. It is used to calculate both the “surface average heat flux” and the “local peak fire heat flux.” As noted in 4.4.13.2.4.2, the “surface average heat flux” is used to calculate the total heat input into the process fluid for sizing PRDs for the pool fire scenario and when calculating the pressure dynamics when sizing depressuring systems for fires. The “local peak heat flux,” also averaged, is used to calculate the localized maximum wall temperature, which affects the material strength. The effect of wall temperature on absorbed local peak heat flux for pool fires is shown in Figure A.2.

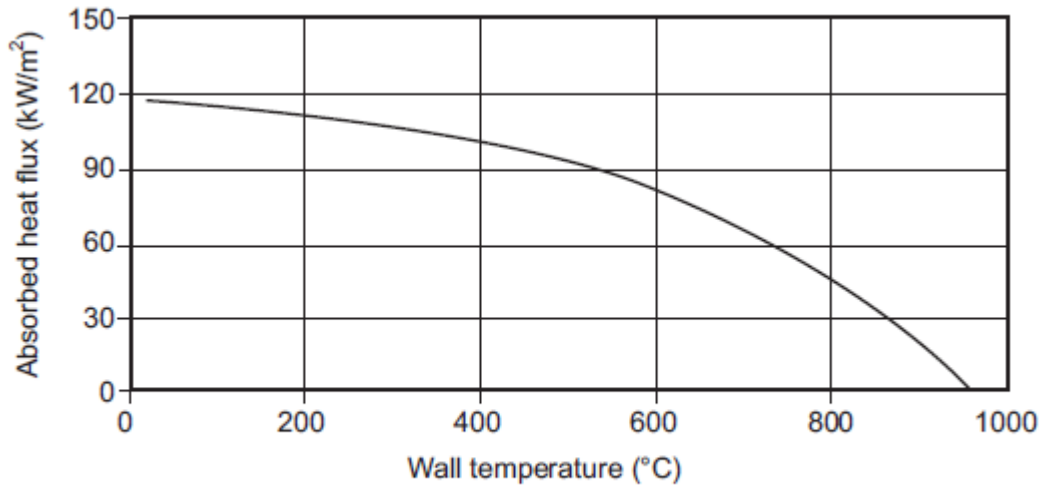

NOTE The absorbed heat flux to the wall is based on the local peak heat fluxes for typical pool fires.

Figure A.2— Typical Effect of Wall Temperature on Absorbed Heat Flux for Pool Fires

The use of time-averaged heat fluxes considers that the peak flux at one particular location on the exposed equipment is rapidly changing within a few seconds due to changes in the fire combustion, wind effects, etc. Because of this averaging, the heat fluxes can be lower than some fire tests reported in the literature which may be instantaneous peaks. The time-averaged heat fluxes are important from an engineering perspective. Note that Equation (A.1) can also be used to calculate dynamic heat-up of structures.

$$q_{\text{absorbed}} = \sigma(\alpha_{\text{surface}} \times \varepsilon_{\text{fire}} \times T_{\text{fire}}^4 - \varepsilon_{\text{surface}} \times T_{\text{surface}}^4) + h(T_{\text{gas}} - T_{\text{surface}}) \quad (\text{A.1})$$

where

q_{absorbed}	is the absorbed heat flux from the fire, expressed in W/m^2 ($\text{Btu}/\text{h}\cdot\text{ft}^2$);
σ	is the Stefan-Boltzmann constant = $5.67 \times 10^{-8} \text{ W}/\text{m}^2\cdot\text{K}^4$ ($0.1713 \times 10^{-8} \text{ Btu}/\text{h}\cdot\text{ft}^2\cdot^\circ\text{R}^4$);
α_{surface}	is the equipment absorptivity, dimensionless;
$\varepsilon_{\text{fire}}$	is the fire emissivity, dimensionless;
$\varepsilon_{\text{surface}}$	is the equipment emissivity, dimensionless;
T_{fire}	is the fire temperature, expressed in K ($^\circ\text{R}$);
T_{surface}	is the equipment temperature, expressed in K ($^\circ\text{R}$);
T_{gas}	is the temperature of air/fire in contact with the equipment surface, expressed in K ($^\circ\text{R}$);
h	is the convection heat transfer coefficient of air/fire in contact with the equipment, $\text{W}/\text{m}^2\cdot\text{K}$ ($\text{Btu}/\text{h}\cdot\text{ft}^2\cdot^\circ\text{R}$);
$\sigma \times \alpha_{\text{surface}} \times \varepsilon_{\text{fire}} \times T_{\text{fire}}^4$	is the radiative heat flux to the equipment;
$\sigma \times \varepsilon_{\text{surface}} \times T_{\text{surface}}^4$	is the reradiation from the equipment;
$h (T_{\text{gas}} - T_{\text{surface}})$	is the convection heat transfer between the combustion gases and the equipment's surface.

In general, the surface area is based on the internal surface area because of convenience. From a heat transfer perspective, it is more appropriate to use the external surface area. However, the differences between the internal and external surface area are small and are generally neglected.

Recommended values of the parameters in Equation (A.1) except the surface temperature are presented in Table A.2 and Table A.3 for pool fires and Table A.4 and Table A.5 for jet fires. Table A.2 through Table A.5 do not consider the effect of mitigation systems such as fire protection or insulation. The parameters are dependent on fuel type, fire size, soot production, type of metal surface (surface emissivity and absorptivity), temperature of the surrounding (preheating of the combustion air, reradiation), etc. and should be investigated in each case. See References [56] and [85] for background on these parameters.

The surface temperature will depend upon the following:

- whether the application is dynamic or steady state;
- whether the application is to determine the size of a relief device, specification of a depressuring system, or determination of the wall temperature of the equipment exposed to the fire; and
- the type of fluid and pressure in the equipment.

It should be noted that, as the surface temperature increases as the fire progresses, the absorbed heat flux (q_{absorbed}) will decrease as indicated in Figure A.2.

Equation (A.1) assumes the surfaces are fully engulfed in a fire. If the entire surface area is not engulfed in the fire but is only exposed to thermal radiation, then the convective term should be disregarded and the radiation term scaled with a fraction between 0 and 1. The scaling factor (i.e. view factor) will depend upon the equipment configuration in relation to the fire and has to be determined in each specific case. See Reference [34] for details on view factors.

Table A.2 through Table A.5 report calculated fire heat fluxes, q_{fire} , and absorbed heat fluxes to equipment surfaces, $q_{absorbed}$, for the recommended parameters when the equipment temperature is $< 323\text{ K}$ ($582\text{ }^\circ\text{R}$). The fire heat flux is the heat flux at the flame surface, whereas the absorbed heat flux includes reradiation from the equipment. The fire heat flux is calculated by ignoring the reradiation [i.e. by setting $\epsilon_{surface} = 0$, setting $\alpha_{surface} = 1$, and setting the equipment temperature $< 323\text{ K}$ ($582\text{ }^\circ\text{R}$) in Equation (A.1)]. It should always be made clear whether the fire load used in the calculation is the absorbed heat based on cold equipment or the fire heat flux.

The gas temperature, T_{gas} , in the convective heat transfer term is the combustion gas temperature. It is equal to the fire temperature when the fire engulfs or impinges on the equipment’s surface. An impinging fire should be assumed when calculating the local peak heat input. However, when calculating the surface average heat input to the equipment for use in sizing PRDs, for example, a temperature less than the fire temperature, T_{fire} , is recommended because the average temperature of the combustion gases flowing over the fire-exposed surface will be less than the fire temperature.

A.3.3 Application of Equation (A.1) to Pool Fires

Table A.2 provides typical ranges in values for the parameters in Equation (A.1) for open pool fires. Where fire heat flux parameters are not available for open pool fires, the fire heat input parameters in Table A.3 are recommended.

Table A.2— Typical Range in Equation (A.1) Parameters for an Open Pool Fire

Parameter	Description	Pool Fire	
		Surface Average Heat Flux	Local Peak Heat Flux
ϵ_{fire}	Hydrocarbon flame emissivity	0.6 to 1.0	0.6 to 1.0
$\epsilon_{surface}$	Equipment emissivity	0.3 to 0.8	
$\alpha_{surface}$	Equipment absorptivity		
h	Convective heat transfer coefficient between equipment and surrounding air	10 W/m ² ·K to 30 W/m ² ·K (1.76 Btu/h·ft ² ·°R to 5.28 Btu/h·ft ² ·°R)	
T_{gas}	Temperature of combustion gases flowing over the surface	773 K to 1173 K (500 °C to 900 °C) 1392 °R to 2112 °R (932 °F to 1652 °F)	1173 K to 1423 K (900 °C to 1150 °C) 2112 °R to 2562 °R (1652 °F to 2102 °F)
T_{fire}	Fire temperature	873 K to 1273 K (600 °C to 1000 °C) 1572 °R to 2292 °R (1112 °F to 1832 °F)	
$T_{surface}$	Equipment temperature	NOTE 3	
σ	Stefan-Boltzmann constant	5.67 × 10 ⁻⁸ W/m ² ·K ⁴ (0.1713 × 10 ⁻⁸ Btu/h·ft ² ·°R ⁴)	
q_{fire}	NOTE 1	30 kW/m ² to 100 kW/m ² (9510 Btu/h·ft ² to 31,700 Btu/h·ft ²)	60 kW/m ² to 200 kW/m ² (19,020 Btu/h·ft ² to 63,400 Btu/h·ft ²)
$q_{absorbed}$	NOTE 2	25 kW/m ² to 75 kW/m ² (7925 Btu/h·ft ² to 23,775 Btu/h·ft ²)	45 kW/m ² to 150 kW/m ² (14,265 Btu/h·ft ² to 47,750 Btu/h·ft ²)

NOTE 1 Typical range in fire heat flux. A wider range of heat fluxes is possible. The fire heat flux is found by ignoring the reradiation (by setting $\epsilon_{surface} = 0$), setting $\alpha_{surface} = 1$, and setting the equipment temperature $< 323\text{ K}$ ($582\text{ }^\circ\text{R}$).

NOTE 2 Typical range in absorbed heat flux at start of fire [i.e. at wall temperatures of $< 323\text{ K}$ ($582\text{ }^\circ\text{R}$)]. A wider range of heat fluxes is possible.

NOTE 3 The equipment temperature is a variable that increases as the surface heats up.

Table A.3—Recommended Values for Equation (A.1) Parameters for an Open Pool Fire Where Other Data or Information is Unavailable

Parameter	Description	Pool Fire	
		Surface Average Heat Flux	Local Peak Heat Flux
ϵ_{fire}	Hydrocarbon flame emissivity	0.75	0.75
$\epsilon_{\text{surface}}$	Equipment emissivity	0.75	
α_{surface}	Equipment absorptivity		
h	Convective heat transfer coefficient between equipment and surrounding air	20 W/m ² ·K (3.52 Btu/h·ft ² ·°R)	
T_{gas}	Temperature of combustion gases flowing over the surface	873 K (600 °C) 1572 °R (1112 °F)	1323 K (1050 °C) 2382 °R (1922 °F)
T_{fire}	Fire temperature	1023 K (750 °C) 1842 °R (1382 °F)	
T_{surface}	Equipment temperature	NOTE 3	
σ	Stefan-Boltzmann constant	5.67 × 10 ⁻⁸ W/m ² ·K ⁴ (0.1713 × 10 ⁻⁸ Btu/h·ft ² ·°R ⁴)	
q_{fire}	NOTE 1	60 kW/m ² (19,020 Btu/h·ft ²)	150 kW/m ² (47,550 Btu/h·ft ²)
q_{absorbed}	NOTE 2	45 kW/m ² (14,265 Btu/h·ft ²)	120 kW/m ² (38,040 Btu/h·ft ²)
NOTE 1 The fire heat flux is found by ignoring the reradiation (by setting $\epsilon_{\text{surface}} = 0$), setting $\alpha_{\text{surface}} = 1$, and setting the equipment temperature < 323 K (582 °R). The values are rounded up/down.			
NOTE 2 The absorbed heat flux at start of fire [i.e. at wall temperatures of < 323 K (582 °R)]. The values are rounded up/down.			
NOTE 3 The equipment temperature is a variable that increases as the surface heats up.			

Confined fires often have a higher flux than open fires, but the effect of confinement is regarded moderate for small and medium size confined fires because the heat-up of the confinement will be slow (compared to the equipment depressurization time, for example) and limited. Note that heat-up of the confinement causes preheating of the combustion air and reduced reradiation resulting in higher heat fluxes. Where the main objective is protection of process piping and equipment through prevention of small (and controllable) fires to escalate to larger (and possibly uncontrollable) fires, the large confined fires can generally be disregarded and confined fires can be modeled as an open fire^[148]. In these cases, the parameters in Table A.2 and Table A.3 can generally be applied because small, confined fires are fuel controlled (i.e. have excess air available for combustion). On the other hand, if the ratio between fire volume and confined volume becomes large, the fire temperature should be increased.

A.3.4 Application of Equation (A.1) to Jet Fires

Table A.4 provides typical ranges in values for the parameters in Equation (A.1) for jet fires. Where fire heat flux parameters are not available for jet fires, the fire heat input parameters in Table A.5 are recommended. Jet fires are typically divided into small jet fires and large jet fires. A large jet fire is where the leak rate (feeding the fire) is larger than 2 kg/s (4.41 lb/s). For two-phase jet fires the fire emissivity should be increased by 20 % to 30 % but with a maximum of 1.0. Where fire heat flux parameters are not available for a jet fire, the jet fire heat input parameters in Table A.5 are recommended.

Table A.4—Typical Range in Equation (A.1) Parameters for a Jet Fire

Parameter	Description	Jet Fire			
		Surface Average Heat Flux		Local Peak Heat Flux	
Leak rates NOTE 5		> 2 kg/s (> 4.41 lb/s) (large jet)	≤ 2 kg/s (≤ 4.41 lb/s) (small jet)	> 2 kg/s (> 4.41 lb/s) (large jet)	≤ 2 kg/s (≤ 4.41 lb/s) (small jet)
ϵ_{fire}	Hydrocarbon flame emissivity	0.6 to 1.0	NA	0.6 to 1.0	0.6 to 1.0
$\epsilon_{\text{surface}}$	Equipment emissivity	0.3 to 0.8	NA	0.3 to 0.8	0.3 to 0.8
α_{surface}	Equipment absorptivity		NA		
h	Convective heat transfer coefficient between equipment and surrounding air	10 W/m ² ·K to 100 W/m ² ·K (1.76 Btu/h·ft ² ·°R to 17.6 Btu/h·ft ² ·°R)	NA	50 W/m ² ·K to 150 W/m ² ·K (8.8 Btu/h·ft ² ·°R to 26.4 Btu/h·ft ² ·°R)	50 W/m ² ·K to 150 W/m ² ·K (8.8 Btu/h·ft ² ·°R to 26.4 Btu/h·ft ² ·°R)
T_{gas}	Temperature of combustion gases flowing over the surface	573 K to 1173 K (300 °C to 900 °C) 1032 °R to 2112 °R (572 °F to 1652 °F)	NA	1173 K to 1523 K (900 °C to 1250 °C) 2112 °R to 2742 °R (1652 °F to 2282 °F)	1123 K to 1473 K (850 °C to 1200 °C) 2022 °R to 2652 °R (1562 °F to 2192 °F)
T_{fire}	Fire temperature	773 K to 1273 K (500 °C to 1000 °C) 1392 °R to 2292 °R (932 °F to 1832 °F)	NA		
T_{surface}	Equipment temperature	NOTE 3			
σ	Stefan-Boltzmann constant	5.67 × 10 ⁻⁸ W/m ² ·K ⁴ (0.1713 × 10 ⁻⁸ Btu/h·ft ² ·°R ⁴)			
q_{fire}	NOTE 1	40 kW/m ² to 150 kW/m ² (12,680 Btu/h·ft ² to 47,550 Btu/h·ft ²)	NA	150 kW/m ² to 400 kW/m ² (47,550 Btu/h·ft ² to 126,800 Btu/h·ft ²)	150 kW/m ² to 300 kW/m ² (47,550 Btu/h·ft ² to 95,100 Btu/h·ft ²)
q_{absorbed}	NOTE 2	30 kW/m ² to 120 kW/m ² (9510 Btu/h·ft ² to 38,040 Btu/h·ft ²)	NA	120 kW/m ² to 320 kW/m ² (38,040 Btu/h·ft ² to 101,440 Btu/h·ft ²)	120 kW/m ² to 250 kW/m ² (38,040 Btu/h·ft ² to 79,250 Btu/h·ft ²)

NOTE 1 Typical range in fire heat flux against a cold surface. A wider range of heat fluxes is possible. The fire heat flux is found by ignoring the reradiation (by setting $\epsilon_{\text{surface}} = 0$), setting $\alpha_{\text{surface}} = 1$, and setting the equipment temperature < 323 K (582 °R).

NOTE 2 Typical range in absorbed heat flux at start of fire [i.e. at wall temperatures of < 323 K (582 °R)]. A wider range of heat fluxes is possible.

NOTE 3 The equipment temperature is a variable that increases as the surface heats up.

NOTE 4 See also References [56] and [85] where recommended parameters for different fires (pool and jet fires) are presented.

NOTE 5 Because a large jet fire will move in location when its size is reduced (the source being depressurized), the small residual jet at the end of the fire duration will normally not expose the same pipes/equipment as the larger jet (i.e. the small jet fire does normally not follow the large jet when calculating the heat-up of the wall).

Table A.5—Recommended Values for Equation (A.1) Parameters for a Jet Fire Where Other Data or Information Is Unavailable

Parameter	Description	Jet Fire			
		Surface Average Heat Flux		Local Peak Heat Flux	
Leak rates NOTE 5		> 2 kg/s (> 4.41 lb/s) (large jet)	≤ 2 kg/s (≤ 4.41 lb/s) (small jet)	> 2 kg/s (> 4.41 lb/s) (large jet)	≤ 2 kg/s (≤ 4.41 lb/s) (small jet)
ϵ_{fire}	Hydrocarbon flame emissivity	0.33	NA	0.87	0.75
$\epsilon_{\text{surface}}$	Equipment emissivity	0.75	NA	0.75	0.75
α_{surface}	Equipment absorptivity		NA		
h	Convective heat transfer coefficient between equipment and surrounding air	40 W/m ² ·K (7.04 Btu/h·ft ² ·°R)	NA	100 W/m ² ·K (17.6 Btu/h·ft ² ·°R)	90 W/m ² ·K (15.8 Btu/h·ft ² ·°R)
T_{gas}	Temperature of combustion gases flowing over the surface	1173 K (900 °C) 2112 °R (1652 °F)	NA	1473 K (1200 °C) 2652 °R (2192 °F)	1373 K (1100 °C) 2472 °R (2012 °F)
T_{fire}	Fire temperature	1373 K (1100 °C) 2472 °R (2012 °F)	NA		
T_{surface}	Equipment temperature	NOTE 3			
σ	Stefan-Boltzmann constant	5.67 × 10 ⁻⁸ W/m ² ·K ⁴ (0.1713 × 10 ⁻⁸ Btu/h·ft ² ·°R ⁴)			
q_{fire}	NOTE 1	100 kW/m ² (31,700 Btu/h·ft ²)	NA	350 kW/m ² (110,950 Btu/h·ft ²)	250 kW/m ² (79,250 Btu/h·ft ²)
q_{absorbed}	NOTE 2	85 kW/m ² (26,945 Btu/h·ft ²)	NA	290 kW/m ² (91,930 Btu/h·ft ²)	210 kW/m ² (66,570 Btu/h·ft ²)

NOTE 1 Typical range in fire heat flux against a cold surface. A wider range of heat fluxes is possible. The fire heat flux is found by ignoring the reradiation (by setting $\epsilon_{\text{surface}} = 0$), setting $\alpha_{\text{surface}} = 1$, and setting the equipment temperature < 323 K (582 °R).

NOTE 2 Typical range in absorbed heat flux at start of fire [i.e. at wall temperatures of < 323 K (582 °R)]. A wider range of heat fluxes is possible.

NOTE 3 The equipment temperature is a variable that increases as the surface heats up.

NOTE 4 See also References [56] and [85] where recommended parameters for different fires (pool and jet fires) are presented.

NOTE 5 Because large jet fire will move in location when its size is reduced (the source being depressurized), the small residual jet at the end of the fire duration will normally not expose the same pipes/equipment as the larger jet (i.e. the small jet fire does normally not follow the large jet when calculating the heat-up of the wall).

A.3.5 Application of the Analytical Method to Depressuring System Design

A.3.5.1 General

One approach to mitigation of pressure vessels and other equipment containing unwetted surfaces exposed to fire would be to design a depressuring system which would reduce the pressure in the equipment at a rate sufficient to keep the stress below the vessel's material strength at temperature (see 4.6 for discussion). The effect of high temperature on carbon steel strength is illustrated in Figure 2.

Note that other mitigations such as insulation, water sprays, etc. are discussed in 4.4.13.2.6 and 4.4.13.2.7.

A.3.5.2 Dynamic Simulation

The design of a vapor depressuring system will normally require dynamic simulations. Equation (A.1) is useful for calculation of temperature response of the wall. This temperature can be used directly in the calculation of rupture stress (wall heat-up) and indirectly in the calculation pressure response of the system (see A.3.5.4.2).

When using Equation (A.1) in dynamic calculations, a good engineering approach is to treat the surface temperature, T_{surface} , as the only variable in Equation (A.1). More rigorous calculation models would also treat emissivities, absorptivities, temperatures, and the fire convective heat transfer coefficient as variables as the fire develops.

The temperature response of an unwetted wall will be different from a wall that is in contact with liquid. The main reasons are differences in heat transfer coefficient and thermal mass (i.e. $m \times C_p$), for vapors and liquids. The heat transfer to gases is usually much lower than for liquids (typically 5 % to 10 % of the liquid heat transfer) and the thermal mass of the gas is usually much lower than for liquids, both resulting in a much more rapid heat-up of a wall in contact with gas than a wall in contact with liquid. Dynamic calculations should include separate temperature calculations of the unwetted and wetted surfaces.

A.3.5.3 Required Information Prior to Calculation

A.3.5.3.1 Acceptance Criteria

Although the intent is to avoid rupture, criteria for deciding if the consequences of a rupture are unacceptable need to be established (see 4.6.5).

A.3.5.3.2 System Information

It is important for the pressure and temperature profile calculations that the input data for the analysis are as correct and complete as possible.

The input for a complete analysis normally includes:

- a) description of the process section that requires depressuring (i.e. vessels, piping, and other equipment between isolation valves):
 - 1) geometry (volume, surface area, weight, etc.);
 - 2) process parameters (operating pressure, temperature, composition of fluids, etc.);
 - 3) material data (type of construction material for vessels, piping and other equipment, dimensions, properties at elevated temperatures, etc.);
- b) description of the depressurization system characteristics:
 - 1) method for depressurization initiation (manual or automatic);
 - 2) time delay for initiation of depressurization;
 - 3) capacity of the flare system (capacity of the flare system may be influenced by the analysis; i.e. in some cases, it will be an output from the fire depressurization design).

For more detailed description of input parameters [e.g. material properties at elevated temperatures, wall thickness variations due to production (mill) tolerance and corrosion, etc.], see Reference [148].

A.3.5.3.3 Fire Scenario

The fire scenarios shall be defined [i.e. type of fire, fire duration, fire size (exposed area), and fire heat fluxes]. The parameters resulting in the design fire heat load (see A.3.3 and A.3.4) should be defined for each fire area. The fire duration is also limited to the time that vessels, piping, and other equipment need to be protected from failure caused by fire (see A.3.5.4.1).

A.3.5.3.4 Failure Criterion

A failure criterion for the material applied in the process segment needs to be established. Normally such a criterion requires knowledge of the material's ultimate tensile strength (UTS) at elevated temperatures. The engineering procedure described in A.3.5.4 applies only UTS data and defines rupture when the total stress exceeds the UTS.

More sophisticated methods will use elongation/deformation as failure criteria. Note that the types of stresses considered are discussed in A.3.5.4.4 for vessels and A.3.5.4.5 for piping.

A.3.5.4 Design Procedure

A.3.5.4.1 Work Flow

The design procedure is roughly divided into the following steps.

- Step 1: Calculate the pressure profile.
- Step 2: Calculate the temperature profile for all pipes/vessels exposed to fire to establish the UTS profile.
- Step 3: Calculate the stress profile.
- Step 4: Compare the stress profile with the stress capacity (e.g. UTS profile).

Rupture is defined when the actual stress exceeds the UTS. This is illustrated in Figure A.3. Figure A.4 describes the work flow for vessels and pipes.

Step 1 typically involves one or a few calculations per section requiring depressurization. Steps 2 and 3 involve several calculations per section requiring depressurization because a change in pipe/vessel dimension (diameter and/or wall thickness) and type of material (e.g. carbon steel, stainless steel) will result in a change in the temperature profile [i.e. one calculation per change in thermal mass ($m \times C_p$) per unit of surface area].

A.3.5.4.2 Pressure Profile

A.3.5.4.2.1 General

The pressure profile calculation typically involves no more than a few calculations per section requiring depressurization. As in the case of fire-relief sizing, this calculation requires the surface average heat input from the fire, not the local peak heat input.

Table A.6 gives some typical starting points for Step 1. The typical values for pipes/vessels with design pressures below 100 barg (1450 psig) are related to jet fire exposure to avoid rupture during typical times required for escape. For higher design pressures (e.g. thick-walled pipe/vessel) and for pool fire exposure, the time to rupture will be longer due to a slower heat-up. In these cases, 15 min is often used as the starting point for Step 1. The selection of an appropriate depressurization rate should consider that reducing the depressurization rate increases the potential consequences of leakage or rupture (see 4.6.6). The actual depressuring rate will be dependent on the prevailing acceptance criteria for the installation (see 4.6.5).

As an alternative starting point, the wall thickness of the equipment can be used to specify the depressurization times (see A.3.5.4.6).

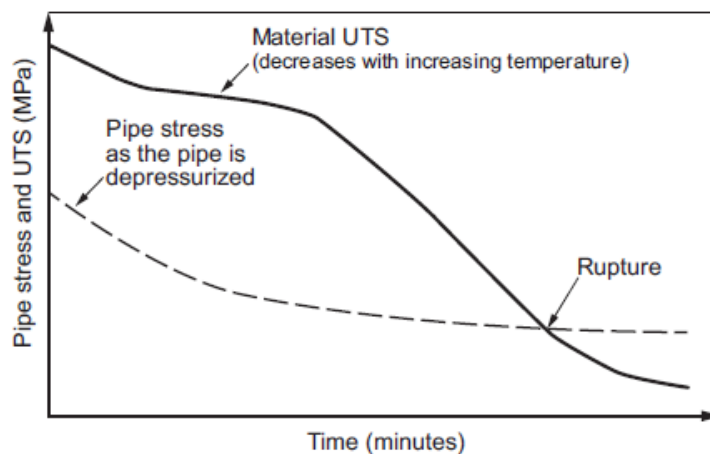

NOTE The pipe will rupture when the pipe stress exceeds the material UTS.

Figure A.3—Illustration of Actual Stress Compared with the UTS for a Fire Exposed Pipe That Is Depressurized

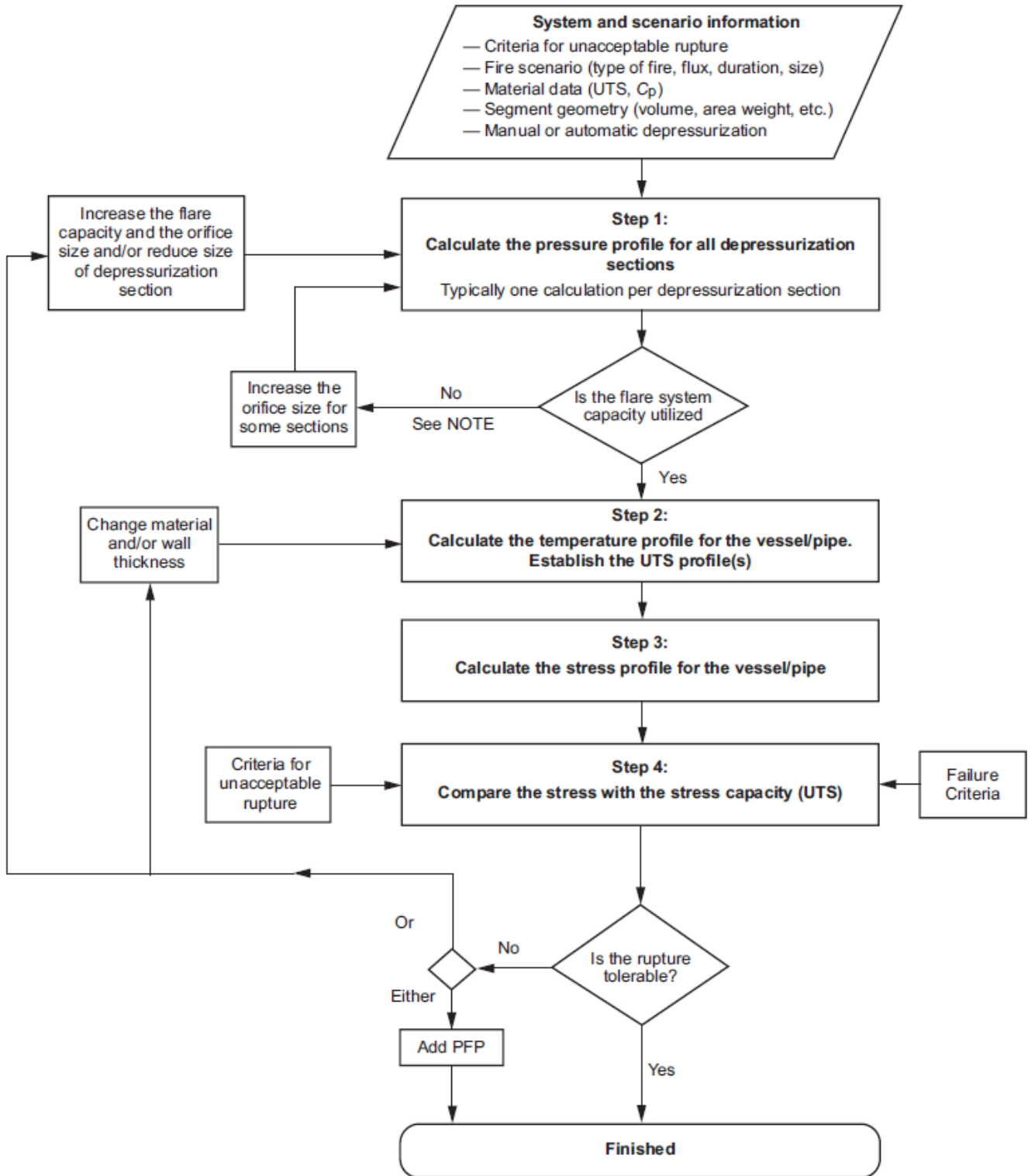

NOTE If the flare system capacity is not utilized, it is recommended to increase the depressurization rate for some depressurization sections, preferably those that represent the highest risk potential.

Figure A.4—Fire Depressurization Work Flow Diagram

Table A.6—Typical Starting Points for Step 1 in Figure A.4 When Designing Depressurization System for Unwetted Walls Exposed to Jet Fires

Pipe/Vessel Design Pressure	Typical Time (min) to Depressure to 7 barg (100 psig)
20 barg (290 psig)	4 to 5
50 barg to 100 barg (725 psig to 1450 psig)	7 to 8
> 100 barg (> 1450 psig)	~15

A.3.5.4.2.2 Area Exposed to the Surface Average Flux

Because the fire heat flux is heat per unit area [i.e. kW/m² (Btu/h·ft²)], the surface area exposed to the fire needs to be estimated in each case to calculate the total heat added [kW (Btu/h)] to the object. This requires a rough estimation of the expected flame size. For pool fires methods exist for estimating the flame volume, and flame lengths can be estimated for jet fires. For typical jet fire flame length, see Reference [85].

NOTE For jet fires the flame shape changes when the jet impinges on objects such as vessels, pipe racks, etc.

For engineering purposes, it is recommended to use the surface area that is likely to be exposed to the fire for the surface average flux. A more detailed calculation would be to split the area in two—for example, area inside the fire and exposed area outside the fire, with the first being exposed to both radiation and convection and the second being exposed to a lower flux mainly from radiation. In this case, sophisticated simulation tools would be required to integrate the flux over the total area to get the total absorbed heat.

A.3.5.4.2.3 Heat Flow to the Fluid

The pressure profile during depressurization is dependent on the heat transfer to the inside fluids (gas phase and liquid phase). The convective heat flux to the fluid is calculated as the product of the inside heat transfer coefficient and the temperature difference between the wall and the inside fluid [see Equation (A.2)]. Both the convective heat transfer coefficient, h , and the temperature difference ($T_{\text{surface}} - T_{\text{fluid}}$) change during heat-up and depressurization. Hence, the resultant heat flux to the fluid needs to be calculated in every time step.

$$q_{\text{fluid}} = h(T_{\text{surface}} - T_{\text{fluid}}) \quad (\text{A.2})$$

where

- q_{fluid} is the heat flux to the fluid, expressed in W/m² (Btu/h·ft²);
- h is the internal convection heat transfer coefficient, W/m²·K (Btu/h·ft²·°R);
- T_{surface} is the equipment temperature, expressed in K (°R);
- T_{fluid} is the fluid temperature, expressed in K (°R).

For a system that is exposed to fire, the absorbed heat from the fire is highest when the wall is coldest, which typically occurs at the start of fire (see Figure A.2). The absorbed heat is used to heat both the wall and the inside fluid. At the start of fire the wall and inside fluid is close to or at temperature equilibrium [i.e. $dT = (T_{\text{surface}} - T_{\text{fluid}}) \approx 0$], and the absorbed heat is used to heat the wall. As the wall heats up, dT increases as does the internal heat transfer coefficient with more of the wall's absorbed heat from the fire heating the fluid. Note that the internal heat transfer is primarily by thermal radiation and free convection. Both thermal radiation and free convection increase with an increasing temperature difference between the wall and the fluid.

At some wall temperature during heat-up, the absorbed heat to the wall from the fire is closely balanced by the heat transport from the wall to the fluid, and the change in wall temperature per time will approach zero. The fluid is then receiving about the same heat flux as the absorbed heat from Equation (A.1). This heat flux is lower than the initial absorbed heat flux listed in the tables in A.3.3. For a gas it may typically be well below the listed values, whereas for a liquid it is typically in the order of 75 % to 100 % of the initial heat flux, that is, in the order of Equation (7) and Equation (8) in 4.4.13.2.4.2 for a pool fire.

The above indicates that modeling of the internal heat transfer coefficient is required to estimate the pressure profile with some quality. The use of q_{absorbed} from Equation (A.1) as the absorbed heat to the fluid will result in an excessive heat flow to the inside fluid in the period until the wall temperature reaches a near constant temperature. Several methods for modeling vapor and nonboiling liquid heat transfer coefficient are available in the literature. For boiling liquids less information is available, especially for multicomponent liquids, but there are indications of typical numbers in the range of $1000 \text{ W/m}^2\cdot\text{K}$ to $3000 \text{ W/m}^2\cdot\text{K}$ ($176 \text{ Btu/h}\cdot\text{ft}^2\cdot^\circ\text{R}$ to $528 \text{ Btu/h}\cdot\text{ft}^2\cdot^\circ\text{R}$) for multicomponent boiling hydrocarbons exposed to typical fire heat fluxes.

A.3.5.4.3 Temperature Profiles of the Metal

The local peak heat flux from the fire is used when establishing the temperature profiles. By ignoring the cooling effect of the internal fluid, a conservative (more rapid heat-up) calculation will be performed for the chosen fire parameters. The cooling effect is typically much higher for a liquid compared to a gas.

Comparison against rigorous simulation models indicates that the inside heat transfer and thermodynamics can be modeled by:

- a) including a constant gas mass and gas heat capacity at half of the initial pressure and at the initial temperature, and
- b) assuming temperature equilibrium between the gas and the wall.

The comparison was performed for unwetted walls for the local peak heat fluxes listed in the Table A.3 and Table A.5.

The use of simplified methods for the heat-up calculation can be justified given the following:

- a) the uncertainties in fire heat flux modeling require the use of average heat fluxes from the fire, and
- b) the pressure profile is based on limited knowledge of boiling multicomponent heat transfer, a gas heat transfer coefficient that is highly dependent on the geometry, uncertainties with respect to ultimate tensile stress at elevated temperatures, etc.

A.3.5.4.4 Stress Calculation for Vessels

The total stress in vessel is the sum of stress from 1) internal pressure, 2) weight of fluid inside the vessel, 3) the vessel's own weight, 4) thermal expansion stress due to boundary constraints, etc. This can be approximated by only considering the stress resulting from internal pressure in the vessel (see A.3.5.4.6).

A.3.5.4.5 provides equations for the calculation of pipe stress. The piping Equation (A.3) to Equation (A.5) can be used to estimate vessel stress, but it is recommended to perform a more detailed stress analysis because vessels can have high stress components near the nozzles, especially where pipe connected to the nozzle does not move (i.e. is restrained).

A.3.5.4.5 Stress Calculation for Piping

The total stress in a pipe is the sum of stress from 1) internal pressure, 2) weight of fluid inside the element, 3) its own weight, 4) weight of flanges and valves, 5) thermal expansion stress due to boundary constraints, etc.

When considering pipe rupture as a result of fire heat-up, the important stress is that resulting from internal pressure. Longitudinal stress due to system weight and thermal expansion disappears or redistributes to less harmful stresses when a pipe starts to yield. The stress relevant for pipe rupture can then be estimated at each time step from Equations (A.3), (A.4), and (A.5), respectively:

$$\sigma_{\text{hoop}}(t) = \frac{[p(t) \times \text{OD}]}{2 \times \text{wt}} \quad (\text{A.3})$$

$$\sigma_{\text{axial}}(t) = \frac{[p(t) \times \text{OD}]}{4 \times \text{wt}} \quad (\text{A.4})$$

$$\sigma_{\text{Von_Mises}} = \sqrt{\sigma_{\text{hoop}}^2 + \sigma_{\text{axial}}^2 - \sigma_{\text{hoop}} \times \sigma_{\text{axial}}} \quad (\text{A.5})$$

where

- σ_{hoop} is the hoop stress, expressed in MPa (psi);
- σ_{axial} is the axial (longitudinal) stress, expressed in MPa (psi);
- $\sigma_{\text{Von_Mises}}$ is the equivalent (total) stress, expressed in MPa (psi);
- p is the system pressure, expressed in MPa (psi);
- OD is the outer diameter, expressed in m (ft);
- wt is the wall thickness, expressed in m (ft);
- (t) is the time step, dimensionless.

See ISO 10400 (Annex A) ^[93] for further reading.

Because pressure is time-dependent during heat-up and depressurization, the stress components are also time-dependent variables. The hoop stress defined in Equation (A.3) is a simplified equation that assumes constant stress across the thickness.

Unless more accurate methods are available, Equation (A.3) to Equation (A.5) can be applied to piping, including bends. By ignoring the axial pressure stress component, a slightly higher equivalent (total) stress is calculated.

A.3.5.4.6 Application of Analytical Method to Development of Depressurization Criteria

As an alternative to the stress calculations discussed in A.3.5.4.5, the analytical method can be applied. For example, the parameters in Table C.3 used to generate Figure C.8 can be used to determine the temperature versus time for several thicknesses of unwetted carbon steel exposed to a pool fire. These curves can be combined with tensile strength versus temperature data to determine the tensile strength of a vessel's unwetted surfaces versus time in a pool fire. If the internal pressure and other stresses imposed on the vessel (e.g. weight of the vessel, restrictions in metal expansion) exceed the tensile strength at temperature, then failure will occur.

Tensile strength versus temperature data ^[164] for carbon steel and stainless steel are given in Table A.7. See Reference [148] for data on several other materials. For example, a vessel fabricated from SA-516 carbon steel with a design stress of, say, 138 MPa (20,000 psi) was subject to a pool fire exhibiting heat-up profiles similar to that shown in Figure C.9 (i.e. all surfaces are unwetted). In this case, if the vessel pressure was held at its design pressure and the only stress is the internal pressure in the vessel, then failure will occur when the unwetted wall temperature reaches 649 °C (1200 °F). At this point, the tensile strength at temperature shown in Table A.7 equals the design stress. Failure can occur prior to reaching this temperature if there are other stresses or if held at high

temperature for extended periods (see Figure 2). If the metal wall temperature continues to increase then internal stress (i.e. pressure) needs to be reduced in order to maintain integrity. If heated to 704 °C (1300 °F), the pressure needs to be reduced to below 93.1 MPa/137.9 MPa (13,500 psi/20,000 psi) = 67.5 % of the vessel design pressure. Note that a safety factor can be applied when considering tensile strength in this manner.

Applying this approach to metal thicknesses of 3.2 mm, 12.7 mm, and 25.4 mm (1/8 in., 1/2 in., and 1 in.) along with a safety factor of 0.75 results in Figure A.5. The depressuring system needs to be designed to depressure at least as fast (preferably faster) than the curves shown in Figure A.5 for the appropriate vessel thickness (i.e. stay to the left of the curves).

Table A.7—High-temperature Tensile Strength of Carbon Steel and 18-8 Stainless Steel^[164]

Temperature °F	Temperature °C	18-8 Stainless Steel (304, 304L)		Carbon Steel (SA-515, SA-516)	
		Tensile Strength psi	Tensile Strength MPa	Tensile Strength psi	Tensile Strength MPa
900	482			45,500	313.7
1000	538	53,000	365.4	36,500	251.7
1100	593	48,500	334.4	27,200	187.5
1200	649	43,000	296.5	20,000	137.9
1300	704	35,000	241.3	13,500	93.1
1400	760	27,000	186.2	9025	62.2
1500	816	20,500	141.3		
1600	871	17,650	121.7		

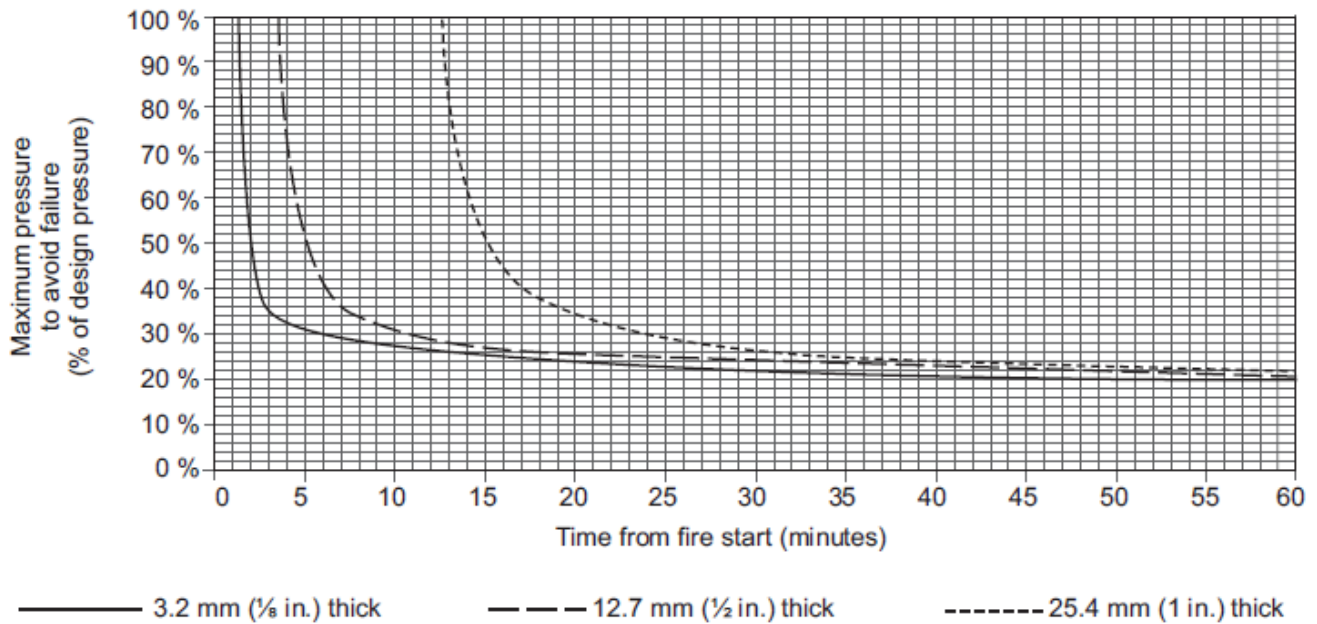

Figure A.5—Minimum Depressuring Rates to Avoid Failure of a Gas-filled Vessel Fabricated from SA-516 Carbon Steel and Exposed to a Pool Fire

A.3.5.5 Mitigation Alternatives to Reduce Depressurization Requirements

A.3.5.5.1 Passive Fire Protection

PFP is considered an effective measure that reduces the heat input due to fire exposure and, thereby, reducing depressurization requirements. However, PFP also introduces problems relating to CUI with the potential for hydrocarbon leaks, reduced possibilities for surface inspection, increased weight and cost, reduced heat absorption, which increases the fire temperature/flux and higher explosion loads. PFP could also require the presence of more maintenance personnel in the plant's process area.

Before using PFP, the design should take full advantage of other measures that can reduce the need for PFP. Such measures can be to select material with higher UTS at elevated temperatures, introduce more pipe support, select a higher pressure rating (increased wall thickness), resizing of the segment volume, increase the flare system capacity, etc.

A.3.5.5.2 Effect of Water on Fire Heat Flux

When sizing PRDs, no credit is taken for water spray systems (see 4.4.13.2.6.2). However, reliable water spray systems can be used to mitigate fire exposure of equipment when designing a depressurization system. The effect of water added to a fire is twofold:

- 1) cooling of the surface (dedicated equipment spray), and
- 2) reduction of the fire heat flux (see 4.4.13.2.6.2).

Where reliable/adequate automatic and/or remote operating fire water systems are installed (e.g. deluge, firewater monitor systems), a reduction of the surface average heat flux can be employed but normally not for the local peak flux. An adequate system will ensure a sufficient quantity and distribution of water in the fire volume^[64].

A.4 Data on Latent Heat of Vaporization of Hydrocarbons

Different hydrocarbon liquids have different latent heats of vaporization even though hydrocarbons as a group behave similarly to one another. The latent heat of vaporization of a pure single-component liquid decreases as the temperature at vaporization increases and then becomes zero at the critical temperature and pressure for that liquid.

Figure A.6 shows the vapor pressures and latent heats of the pure, single-component paraffin hydrocarbon liquids. This chart is directly applicable to such liquids and applies as an approximation to paraffin-hydrocarbon mixtures composed of two components whose relative molecular masses vary no more than by the difference between propane and butane or butane and pentane.

The chart can also be applicable to isomer hydrocarbons, aromatic or cyclic compounds, or paraffin-hydrocarbon mixtures of components that have slightly different relative molecular masses. The equilibrium temperature should be calculated. Using the relationship for the calculated temperature versus vapor pressure, one can obtain the latent heat from Figure A.6. The relative-molecular-mass relationship as shown by the chart is not to be used in such cases; the relative molecular mass of the vapor should be determined from the vapor-liquid equilibrium calculation.

For cases that involve mixtures of components that have a wide boiling range or significantly different relative molecular masses, a rigorous series of equilibrium calculations can be required to estimate vapor generation rates, as discussed in 4.4.13.2.5.2.

Other recognized sources^[10] of latent heat data or methods of calculating latent heat of vaporization should be used where Figure A.6 does not apply.

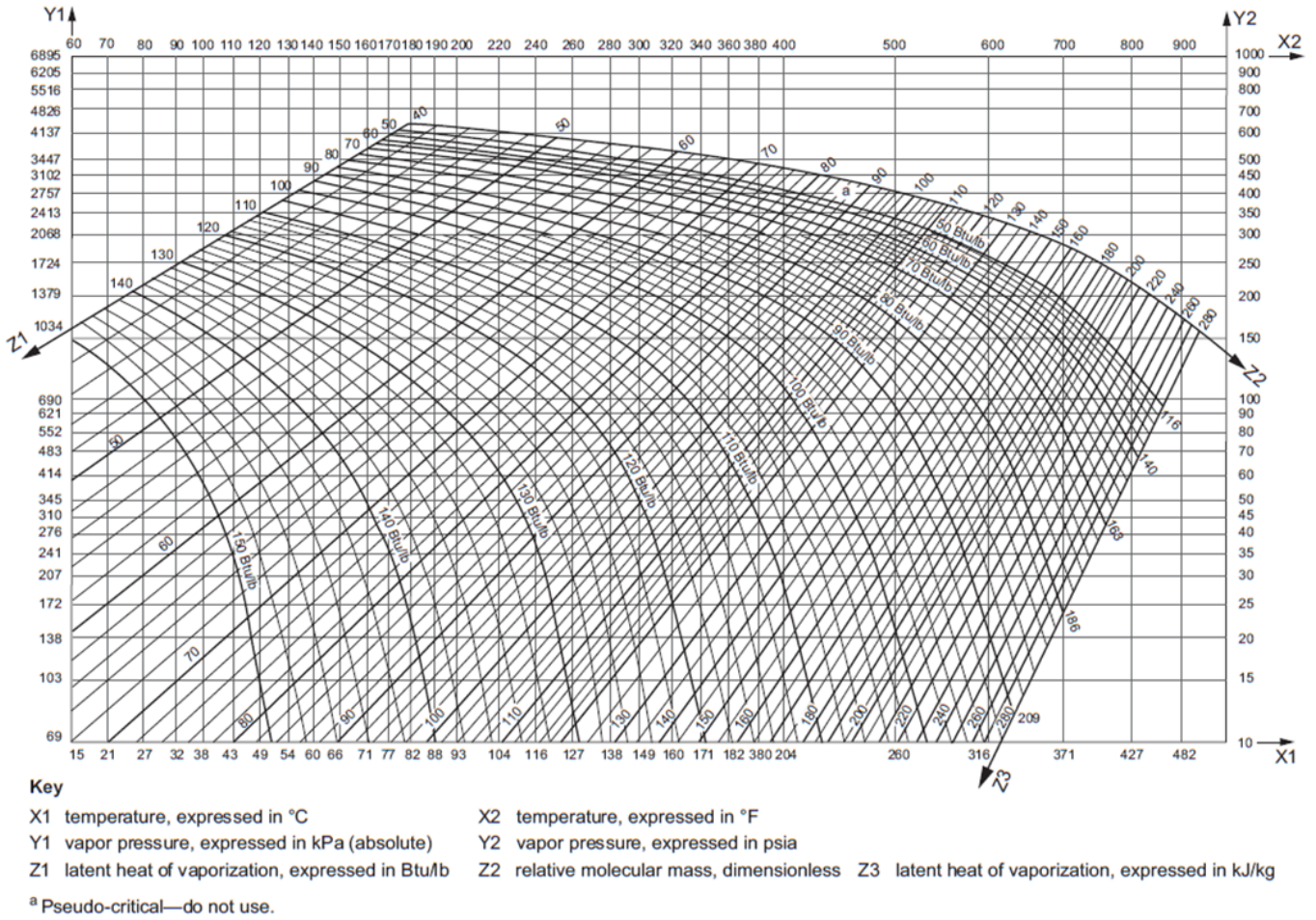

Figure A.6—Vapor Pressure and Heat of Vaporization of Pure, Single-component Paraffin Hydrocarbon Liquids

Annex B (informative)

Special System Design Considerations

B.1 Single PRD Protecting Several Components in a Process System

In some situations, a single PRD can be desirable to protect several equipment components in a process system. For this system to be adequately designed, the following four criteria should be satisfied.

- a) No means can exist for blocking any of the equipment components being protected from the installation of the single PRD unless closure of these valves is positively controlled (e.g. see API 520, Part 2, Section 6).
- b) The set pressure of the first PRD to be actuated should be at or below the lowest design pressure or MAWP of any equipment component being protected in the system.
- c) The accumulated pressure when one or more PRDs are discharging shall not exceed the maximum allowable pressure in accordance with the pressure design code.
- d) The operating pressure in any equipment component shall not exceed that allowed by the pressure design code when the PRD protecting the system is not discharging.

B.2 Description of a Typical Process System

A typical process system that can be provided with only one PRD is a hydrotreater-reactor recycle-gas loop. Such a system can contain the following main equipment components:

- a) recycle gas compressor;
- b) feed/effluent heat exchanger;
- c) fired heater;
- d) reactor;
- e) effluent condenser;
- f) separator drum;
- g) interconnecting piping;
- h) piping for liquid feed, product, and purge gas.

Figure B.1 is a schematic for the typical hydrotreating process system indicated in the preceding list of components.

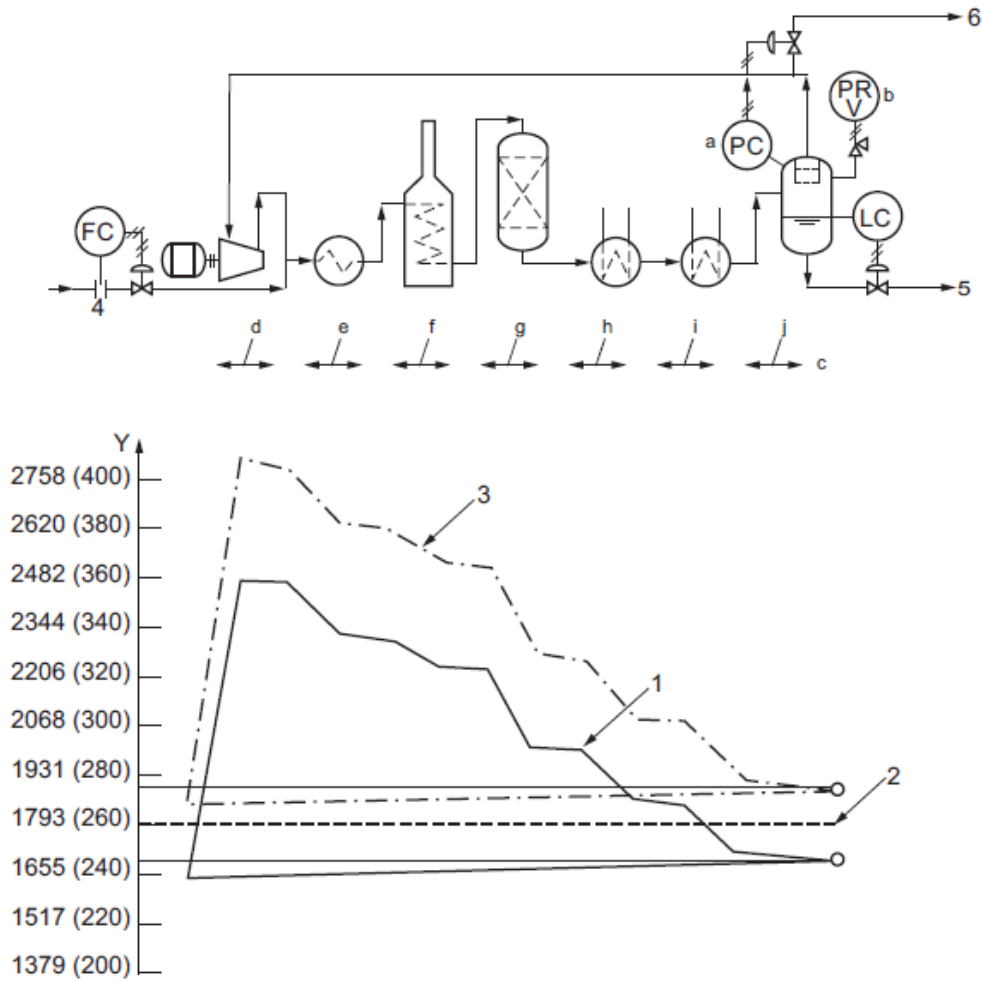

Key

Y pressure, expressed in kPa gauge (psig)

1 pressure profile for normal operation based on end-of-run (EOR) process condition [see B.3 a)]

2 settling-out pressure when system pressure equalizes after compressor stops during normal EOR operation [see B.3 b)]

3 pressure profile when system is operating with the pressure of the HP separator drum at the set pressure of the pressure relief device [see B.3 d)]

4 feed

5 liquid product

6 gas bleed-off

a Normally set at 1689 kPa (245 psig).

b Set at 1896 kPa (275 psig).

c Typical minimum design pressures (DP) for equipment components in the system.

d Compressor: DP = 2799 kPa (406 psi) minimum.

e Feed/product exchange: DP = 2779 kPa (403 psi) minimum.

f Furnace: DP = 2613 kPa (379 psi) minimum.

g Reactor: DP = 2517 kPa (365 psi) minimum.

h Feed/product exchange: DP = 2234 kPa (324 psi) minimum.

i Product condenser: DP = 2062 kPa (299 psi) minimum.

j HP separator: DP = 1896 kPa (275 psi) minimum.

Figure B.1—Typical Flow Scheme of a System Involving a Single PRD Serving Components in a Process System with Typical Pressure Profiles

B.3 Procedure to Calculate the Design Pressure or MAWP of Equipment Components

If the procedure outlined in the following list is followed, the design pressure or MAWP of any equipment component in the system will never be exceeded unless the pressure in the system actuates the PRD. These steps should be taken.

- a) The pressure profile should be developed for the processing conditions that result in the maximum pressure drop (normal end-of-run conditions with fouled equipment).
- b) The settling-out pressure that develops when the compressor stops during the maximum pressure drop case should be calculated. The settling-out pressure (also known as settle-out pressure) is the pressure that the interconnected equipment equalizes to after the compressor stops. The separator drum should be assumed to be operating at normal operating pressure before compressor stoppage and the purge gas line should be assumed to be closed to conserve gas.
- c) The minimum design pressure or MAWP of the separator drum should be calculated as 1.05 times the settling-out pressure. This provides an adequate differential between the operating pressure and set pressure of the PRD for a compressor shutdown contingency.
- d) The pressure profile should be developed for the system with the pressure of the separator drum at the set pressure of the PRD. Assuming equal volumetric gas flow, the pressure gradient is proportional to the change in absolute pressure.

NOTE The minimum design pressure or MAWP of each equipment component is the inlet pressure for each equipment component as determined in Item d).

Annex C (informative)

Sample Calculations

C.1 Flash Calculation

Figure C.1 is an example of an equilibrium-phase diagram for a given liquid having the following evolution.

a) Initial conditions:

- 0 % of the liquid is vaporized;
- $T_a = 256 \text{ }^\circ\text{C}$ (492 °F);
- absolute pressure $p_a = 2861 \text{ kPa}$ (415 psi).

b) The conditions after Step $n = 1$ are as follows:

- 5 % of the liquid is vaporized and 95 % of the liquid remains;
- $T_1 = 252 \text{ }^\circ\text{C}$ (486 °F);
- absolute pressure $p_1 = 2496 \text{ kPa}$ (362 psi).

c) The development of the diagram continues stepwise until depressuring is completed at the following conditions after Step $n = 5$ at Item b):

- 30 % of the liquid is vaporized and 70 % of the liquid remains;
- $T_b = 238 \text{ }^\circ\text{C}$ (461 °F);
- absolute pressure $p_b = 1482 \text{ kPa}$ (215 psi).

For convenience, the mass percent vaporized was assumed to be equal to the volume percent vaporized. By assuming that an incremental part of the liquid (e.g. 5 %) was vaporized during each step, the change in the liquid temperature can be computed using Equation (30). Since the remaining liquid has a saturation temperature and pressure along the 5 %-vaporized line of the phase diagram and the temperature change has been determined using Equation (30), the pressure change is also known. The process is repeated in incremental steps until the pressure, p_b , at the end of the depressuring period is obtained. In Figure C.1, the desired end pressure is reached when the mass fraction, X_i , of the initial liquid in the vessel, i , that has been vaporized is ≈ 0.30 . Substituting this value of X_i into Equation (31) for the last term in Equation (29) gives the estimated mass of liquid flashed as a result of the depressuring from the vessel, i , of the system during a simultaneous fire.

$$(q_{m,v} \times t)_i \approx \left[(q_{m,a} \times t)_i - \frac{Q_i \times t}{2L_i} \right] w_i \quad (\text{C.1})$$

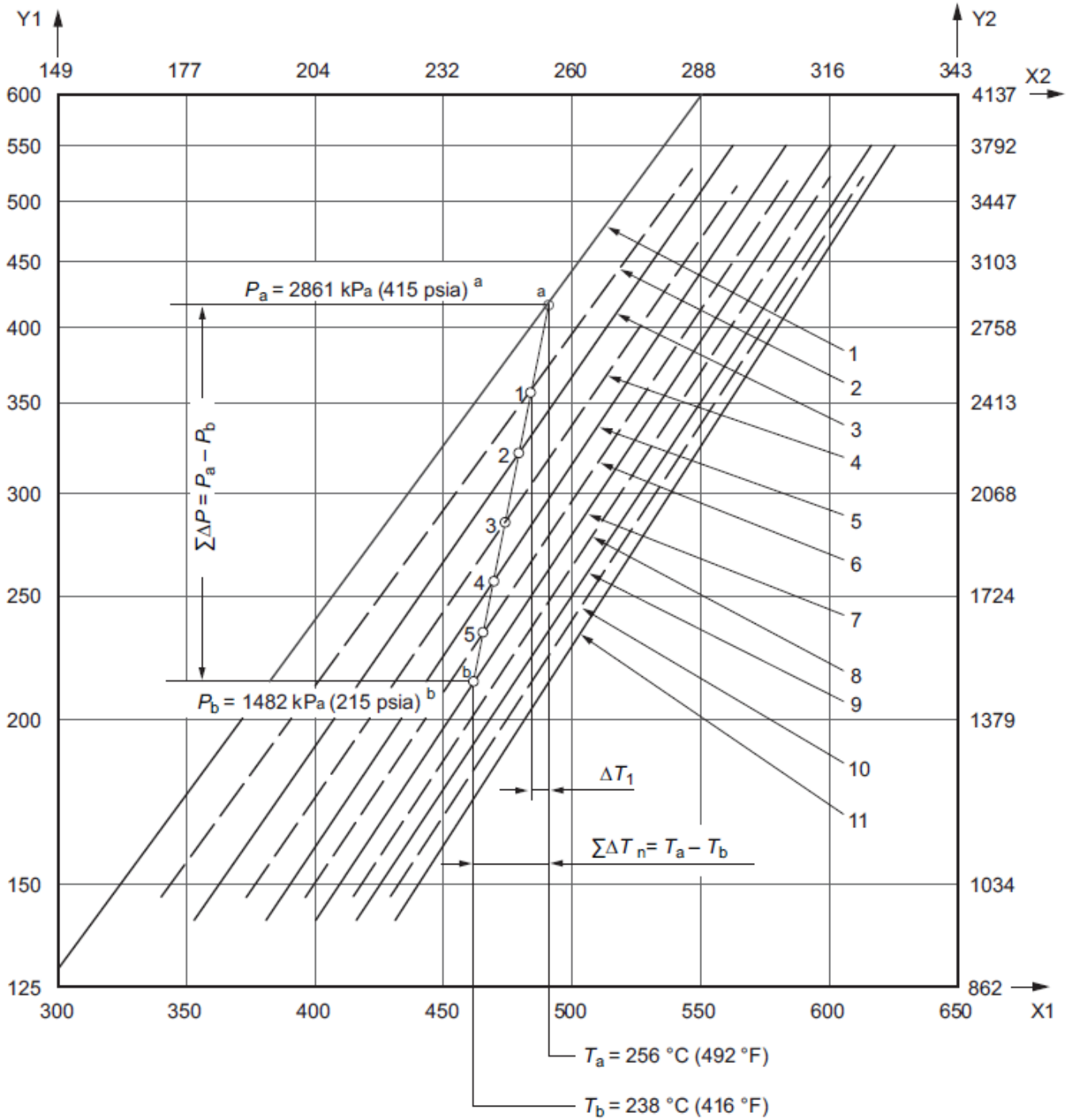

Key

- X1 liquid temperature, expressed in °F
- X2 liquid temperature, expressed in °C
- Y1 pressure, expressed in psig
- Y2 pressure, expressed in kPa
- ^aAt start.
- ^bAt end.

- | | |
|------------------|-------------------|
| 1 0 % vaporized | 7 30 % vaporized |
| 2 5 % vaporized | 8 35 % vaporized |
| 3 10 % vaporized | 9 40 % vaporized |
| 4 15 % vaporized | 10 45 % vaporized |
| 5 20 % vaporized | 11 50 % vaporized |
| 6 25 % vaporized | |

Figure C.1—Equilibrium Phase Diagram for a Given Liquid

C.2 Sizing a Subsonic Flare Stack

C.2.1 General

This annex presents examples of the two methods used to size subsonic flare stacks based on the effects of radiation. The first method covered is the simple approach presented in 5.5.5 and F.2; the second is the more specific approach using Brzustowski's and Sommer's method^[36]. The height and location of the flare stack should be considered, based on gas dispersion if the flame is extinguished (see 5.7.9).

C.2.2 Example 1—Sizing a Flare Stack Using the Simple Approach

C.2.2.1 Basic Data

In this example, the material flowing is hydrocarbon vapors. The mass flow rate, q_m , is 45,360 kg/h (100,000 lb/h). The average relative molecular mass of the vapors, M , is 46.1. The flowing temperature, T , is 422 K (760 °R). The compressibility factor, Z , is 1.0. The heat of combustion is 50,000 kJ/kg (21,500 Btu/lb). The absolute pressure within the flare tip while flaring, p_2 , is 101.3 kPa (14.7 psi). The design wind velocity (u_∞) is 32.2 km/h (8.9 m/s) [20 mph (29.3 ft/s)].

C.2.2.2 Calculation of Flare Diameter

The Mach number is determined from Equation (34) or Equation (35) from 5.5.5.

In SI units:

$$Ma_2 = 3.23 \times 10^{-5} \left(\frac{q_m}{p_2 \times d^2} \right) \left(\frac{Z \times T}{M} \right)^{0.5} \quad (34)$$

In USC units:

$$Ma_2 = 1.702 \times 10^{-5} \left(\frac{q_m}{p_2 \times d^2} \right) \left(\frac{Z \times T}{M} \right)^{0.5} \quad (35)$$

For $Ma_2 = 0.2$, the flare diameter is calculated as follows.

In SI units:

$$0.2 = 3.23 \times 10^{-5} \left(\frac{45,360}{101.3d^2} \right) \sqrt{\frac{1 \times 422}{46.1}}$$

$$d^2 = 0.219$$

$$d = 0.468 \text{ m (inside diameter)}$$

In USC units:

$$0.2 = 1.702 \times 10^{-5} \left(\frac{100,000}{14.7d^2} \right) \sqrt{\frac{1 \times 760}{46.1}}$$

$$d^2 = 2.35$$

$$d = 1.53 \text{ ft (inside diameter)}$$

For $Ma = 0.5$, the flare diameter is calculated as follows.

In SI units:

$$d^2 = 0.088$$

$$d = 0.296 \text{ m (inside diameter)}$$

In USC units:

$$d^2 = 0.94$$

$$d = 0.97 \text{ ft (inside diameter)}$$

C.2.2.3 Calculation of Flame Length

The heat liberated, Q , is calculated as follows (see Figure F.1 and Figure F.2).

In SI units:

$$\begin{aligned} Q &= (45,360 \text{ kg/h}) \times (5 \times 10^4 \text{ kJ/kg}) \times (1 \text{ h}/3600 \text{ s}) \\ &= 6.3 \times 10^5 \text{ kW} \end{aligned}$$

In USC units:

$$\begin{aligned} Q &= (100,000) \times (21,500) \\ &= 2.15 \times 10^9 \text{ Btu/h} \end{aligned}$$

From Figure F.1 and Figure F.2, flame length, L , is 50 m (170 ft). See Figure C.2.

C.2.2.4 Simple Calculation of Flame Distortion Caused by Wind Velocity

The vapor volume flow rate, q_{vap} , is determined as follows.

In SI units:

$$q_{\text{vap}} = \left(\frac{45,360}{3600} \right) \times \left(\frac{22.4}{46.1} \right) \times \left(\frac{422}{273} \right) = 9.46 \text{ m}^3/\text{s (actual)}$$

In USC units:

$$q_{\text{vap}} = \left(\frac{100,000}{3600} \right) \times \left(\frac{379.1}{46.1} \right) \times \left(\frac{760}{520} \right) = 333.9 \text{ ft}^3/\text{s (actual)}$$

The flame distortion caused by wind velocity (see Figure F.3) can be represented by Equation (C.2):

$$\frac{u_{\infty}}{u_j} \tag{C.2}$$

where

u_{∞} is the wind velocity;

u_j is the flare tip velocity.

The flare tip exit velocity, u_j , can be determined from Equation (C.3) (see C.2.3 for another method of calculating u_j):

$$u_j = \frac{q}{\pi d^2 / 4} \quad (\text{C.3})$$

For $Ma = 0.2$:

In SI units:

$$u_j = \frac{9.46}{\pi \times 0.468^2 / 4} = 55 \text{ m/s}$$

In USC units:

$$u_j = \frac{333.9}{\pi \times 1.53^2 / 4} = 181 \text{ ft/s}$$

For $Ma = 0.5$:

In SI units:

$$u_j = \frac{9.46}{\pi \times 0.296^2 / 4} = 137 \text{ m/s}$$

In USC units:

$$u_j = \frac{333.9}{\pi \times 0.97^2 / 4} = 452 \text{ ft/s}$$

At $Ma = 0.2$:

In SI units:

$$\frac{u_\infty}{u_j} = \frac{8.94}{55} = 0.162$$

From Figure F.3: $\sum \frac{\Delta y}{L} = 0.36$

From Figure F.3: $\sum \frac{\Delta x}{L} = 0.85$

$$\sum \Delta y = 0.36 \times 50 = 18 \text{ m}$$

$$\sum \Delta x = 0.85 \times 50 = 42.5 \text{ m}$$

In USC units:

$$\frac{u_\infty}{u_j} = \frac{29.3}{181} = 0.162$$

From Figure F.3: $\sum \frac{\Delta y}{L} = 0.36$

From Figure F.3: $\sum \frac{\Delta x}{L} = 0.85$

$$\sum \Delta y = 0.36 \times 170 = 61 \text{ ft}$$

$$\sum \Delta x = 0.85 \times 170 = 144 \text{ ft}$$

At $Ma = 0.5$:

In SI units:

$$\frac{u_{\infty}}{u_j} = \frac{8.94}{137} = 0.065$$

From Figure F.3: $\sum \frac{\Delta y}{L} = 0.55$

From Figure F.3: $\sum \frac{\Delta x}{L} = 0.68$

$$\sum \Delta y = 0.55 \times 50 = 27.5 \text{ m}$$

$$\sum \Delta x = 0.68 \times 50 = 34.0 \text{ m}$$

In USC units:

$$\frac{u_{\infty}}{u_j} = \frac{29.3}{452} = 0.065$$

From Figure F.3: $\sum \frac{\Delta y}{L} = 0.55$

From Figure F.3: $\sum \frac{\Delta x}{L} = 0.68$

$$\sum \Delta y = 0.55 \times 170 = 93 \text{ ft}$$

$$\sum \Delta x = 0.68 \times 170 = 115 \text{ ft}$$

C.2.2.5 Calculation of Required Flare Stack Height

For the basis of the calculations used in C.2.2.5, see F.2. See Figure C.2 for dimensional references.

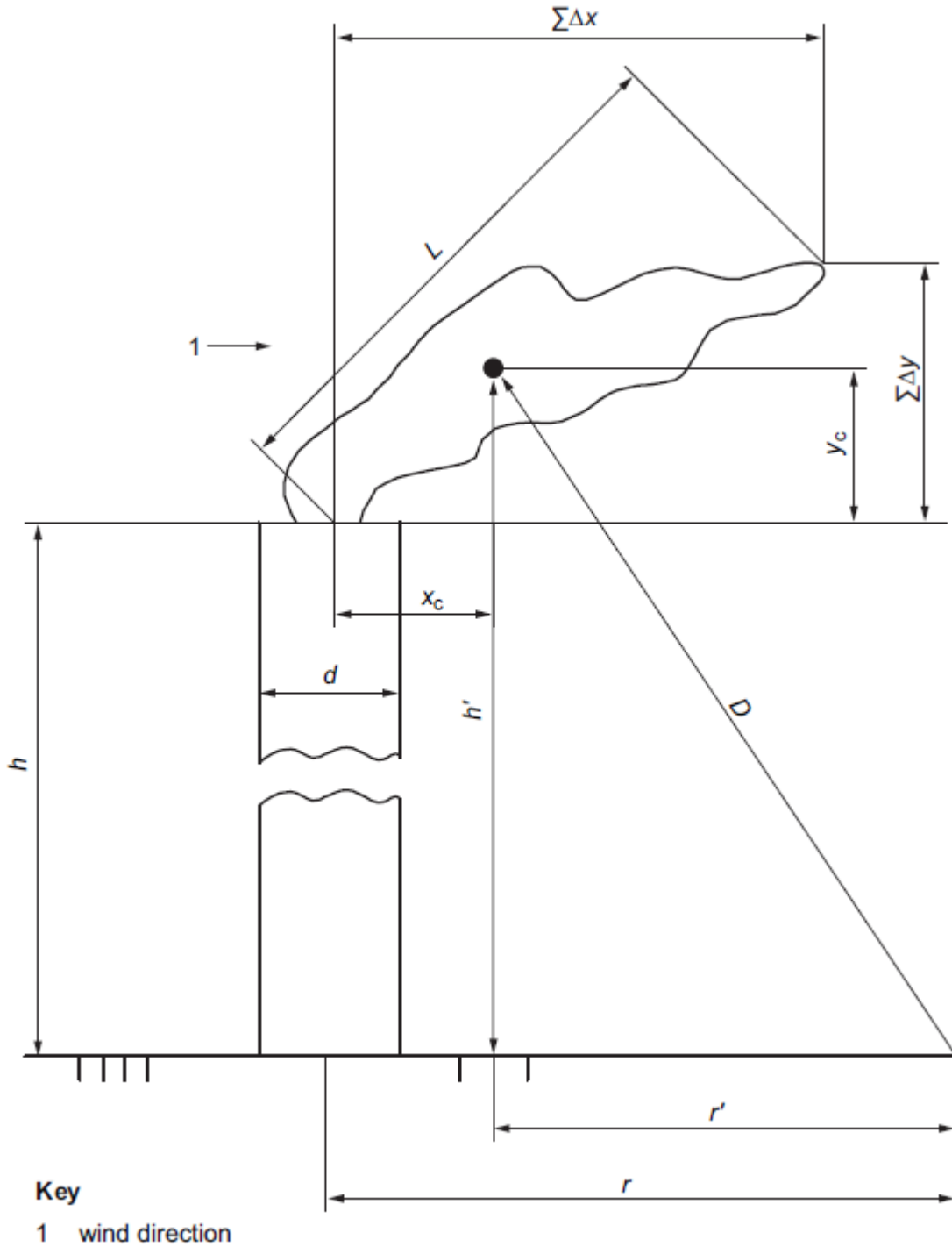

Figure C.2—Dimensional References for Sizing a Flare Stack

The design basis for these calculations is as follows.

The fraction of heat radiated, F , is 0.3. The heat liberated (see C.2.2.3), Q , is 6.3×10^5 kW (2.15×10^9 Btu/h). Assume it is necessary for the flare stack design to limit the maximum allowable radiation, K , at 45.7 m (150 ft) from the flare stack to 6.3 kW/m^2 ($2000 \text{ Btu/h}\cdot\text{ft}^2$).

In Equation (F.1), the value of τ should be assumed to be 1.0. The distance from the flame center to the grade-level boundary (i.e. the object being considered), D , is then calculated according to Equation (F.1):

$$D = \sqrt{\frac{\tau \times F \times Q}{4\pi \times K}} \quad (\text{F.1})$$

In SI units:

$$D = \sqrt{\frac{1.0 \times 0.3 \times 6.3 \times 10^5}{4\pi \times 6.3}} = 48.9 \text{ m}$$

In USC units:

$$D = \sqrt{\frac{1.0 \times 0.3 \times 2.15 \times 10^9}{4\pi \times 2000}} = 160 \text{ ft}$$

The physical arrangement shown in Figure C.2 is the basis of the remaining calculations in C.2.2.5.

At $Ma = 0.2$, the flare stack height, h , is calculated as follows:

$$h' = h + (0.5 \sum \Delta y) \quad (\text{C.4})$$

$$r' = r - (0.5 \sum \Delta x) \quad (\text{C.5})$$

In SI units:

From C.2.2.4, at $Ma = 0.2$: $\sum \Delta y = 18 \text{ m}$

From C.2.2.4, at $Ma = 0.2$: $\sum \Delta x = 42.5 \text{ m}$

Based on a grade level distance from the flare, r , of 45.7 m:

$$r' = 45.7 - (0.5 \times 42.5) = 24.4 \text{ m}$$

and

$$D^2 = r'^2 + h'^2$$

$$48.9^2 = 24.4^2 + h'^2$$

$$h' = 42.3 \text{ m}$$

$$h = 2.3 - (0.5 \times 18) = 33.3 \text{ m}$$

In USC units:

From C.2.2.4, at $Ma = 0.2$: $\sum \Delta y = 61 \text{ ft}$

From C.2.2.4, at $Ma = 0.2$: $\sum \Delta x = 144 \text{ ft}$

Based on a grade level distance from the flare, r , of 150 ft:

$$r' = 150 - (0.5 \times 144) = 78 \text{ ft}$$

and

$$D^2 = r'^2 + h'^2$$

$$160^2 = 78^2 + h'^2$$

$$h' = 140 \text{ ft}$$

$$h = 140 - (0.5 \times 61) = 110 \text{ ft}$$

At $Ma = 0.5$, h is calculated as follows.

In SI units:

From C.2.2.4, at $Ma = 0.5$: $\sum \Delta y = 27.5 \text{ m}$

From C.2.2.4, at $Ma = 0.5$: $\sum \Delta x = 34.0 \text{ m}$

Based on a grade level distance from the flare, r , of 45.7 m:

$$r' = 45.7 - (0.5 \times 34) = 28.7 \text{ m}$$

and

$$D^2 = r'^2 + h'^2$$

$$48.9^2 = 28.7^2 + h'^2$$

$$h' = 39.6 \text{ m}$$

$$h = 39.6 - (0.5 \times 27.5) = 25.9 \text{ m}$$

In USC units:

From C.2.2.4, at $Ma = 0.5$: $\sum \Delta y = 93 \text{ ft}$

From C.2.2.4, at $Ma = 0.5$: $\sum \Delta x = 115 \text{ ft}$

Based on a grade level distance from the flare, r , of 150 ft:

$$r' = 150 - (0.5 \times 115) = 92.5 \text{ ft}$$

and

$$D^2 = r'^2 + h'^2$$

$$160^2 = 92.5^2 + h'^2$$

$$h' = 131 \text{ ft}$$

$$h = 131 - (0.5 \times 93) = 85 \text{ ft}$$

C.2.3 Example 2—Sizing a Flare Using Brzustowski's and Sommer's Approach

C.2.3.1 Basic Data

In this example, based on Brzustowski's and Sommer's method ^[36], the material flowing is hydrocarbon vapors. The flow rate, q_m , is 126 kg/s (1,000,000 lb/h). The relative molecular mass of the flare gas, M_j , is 46.1, and the relative molecular mass of air, M_{∞} , is 29. The normal average wind speed, u_{∞} , is 32.2 km/h (8.9 m/s) [20 mph (29.3 ft/s)]. The velocity of the flare gas at the flare tip, u_j , is measured in m/s (ft/s). The inside diameter of the flare tip, d_j , is measured in m (ft). The absolute pressure within the flare tip while flaring, p_j , is 108 kPa (15.7 psi). The average relative humidity, R_H , is 50 %. The heat of combustion is 50,000 kJ/kg (21,500 Btu/lb). The compressibility factor, Z , is 1.0. The lower explosive limit concentration of the flare gas in air, C_L , measured as a volume fraction, is 0.021 (see C.2.3.6.1). The absolute temperature of the flare gas, T_j , is 422 K (760 °R), and temperature of the air, T_{∞} , is 289 K (520 °R).

The fraction by which the flame radiation is reduced when transmitted through the atmosphere is indicated by τ . The fraction of heat radiated is indicated by F . The heat release, Q , is measured in kW (Btu/h), and the allowable radiation intensity, K , is measured in kW/m² (Btu/h·ft²).

C.2.3.2 Calculation of Flare Diameter

The Mach number is determined as follows (see 5.5.5).

In SI units:

$$Ma_2 = 3.23 \times 10^{-5} \left(\frac{q_m}{p_2 \times d^2} \right) \left(\frac{Z \times T}{M} \right)^{0.5} \quad (34)$$

In USC units:

$$Ma_2 = 1.702 \times 10^{-5} \left(\frac{q_m}{p_2 \times d^2} \right) \left(\frac{Z \times T}{M} \right)^{0.5} \quad (35)$$

For $Ma = 0.5$, the flare diameter is calculated as follows.

In SI units:

$$0.5 = 3.23 \times 10^{-5} \left(\frac{453,600}{108 d_j^2} \right) \left(\frac{1 \times 422}{46.1} \right)^{0.5}$$

$$d_j^2 = 0.82$$

$$d_j = 0.91 \text{ m}$$

In USC units:

$$0.5 = 1.702 \times 10^{-5} \left(\frac{1,000,000}{15.7 d_j^2} \right) \left(\frac{1 \times 760}{46.1} \right)^{0.5}$$

$$d_j^2 = 8.8$$

$$d_j = 2.97 \text{ ft}$$

C.2.3.3 Location of Flame Center

The tip exit velocity, u_j , is calculated as follows.

In SI units:

$$\begin{aligned} \text{Isothermal Sonic Velocity} &= 91.2(T_j/M_j)^{0.5} \\ &= 91.2 \times (422/46.1)^{0.5} = 276 \text{ m/s} \end{aligned} \quad (\text{C.6})$$

$$\begin{aligned} u_j &= \text{Jet Mach Number} \times \text{Sonic Velocity} \\ &= (0.5) \times (276) = 138 \text{ m/s} \end{aligned}$$

In USC units:

$$\begin{aligned} \text{Isothermal Sonic Velocity} &= 223(T_j/M_j)^{0.5} \\ &= 223 \times (760/46.1)^{0.5} = 905 \text{ ft/s} \end{aligned} \quad (\text{C.7})$$

$$\begin{aligned} u_j &= \text{Jet Mach Number} \times \text{Sonic Velocity} \\ &= (0.5) \times (905) = 453 \text{ ft/s} \end{aligned}$$

The lower explosive limit concentration parameter for the flare gas, \bar{C}_L , is calculated as follows:

$$\bar{C}_L = C_L \left(\frac{u_j}{u_\infty} \right) \left(\frac{M_j}{M_\infty} \right) \quad (\text{C.8})$$

In SI units:

$$\bar{C}_L = 0.021 \times \left(\frac{138}{8.9} \right) \times \left(\frac{46.1}{29} \right) = 0.517$$

In USC units:

$$\bar{C}_L = 0.021 \times \left(\frac{453}{29.3} \right) \times \left(\frac{46.1}{29} \right) = 0.516$$

The parameter for jet thrust and wind thrust, $(d_j \times R)$, is calculated as follows (see C.2.3.6.2):

$$d_j \times R = d_j \left(\frac{u_j}{u_\infty} \right) \left(\frac{T_\infty \times M_j}{T_j} \right)^{0.5} \quad (\text{C.9})$$

In SI units:

$$d_j \times R = 0.91 \times 138/8.9 \times (289 \times 46.1/422)^{0.5} = 79.3$$

In USC units:

$$d_j \times R = 2.97 \times 453/29.3 \times (520 \times 46.1/760)^{0.5} = 258$$

The horizontal and vertical distances from the flare tip to the flame center, x_c and y_c , respectively, are determined as follows.

From Figure C.3, at $\bar{C}_L = 0.517$ and $(d_j \times R) = 79.3$: $x_c = 18$ m.

From Figure C.4, at $\bar{C}_L = 0.516$ and $(d_j \times R) = 258$: $x_c = 58$ ft.

From Figure C.5, at $\bar{C}_L = 0.517$ and $(d_j \times R) = 79.3$: $y_c = 30$ m.

From Figure C.6, at $\bar{C}_L = 0.516$ and $(d_j \times R) = 258$: $y_c = 100$ ft.

C.2.3.4 Calculation of the Distance from the Flame Center to the Object or Point Being Considered

The design basis for this calculation is as follows: The fraction of heat radiated, F , is 0.3. The heat liberated (see C.2.2.3), Q , is 6.3×10^6 kW (2.15×10^{10} Btu/h). Say the flare stack is designed to limit the maximum allowable radiation (see 5.7.2.1), K , to 9.5 kW/m² (3000 Btu/h·ft²).

In Equation (F.1), the value of τ should be assumed to be 1.0 (see C.2.3.6.3 and C.2.3.6.4). The distance from the flame center to the object or point being considered (i.e. the distance to the limit of the radiant heat intensity, such as grade level, an equipment platform, or a plant boundary), D , is then calculated as follows:

$$D = \sqrt{\frac{\tau \times F \times Q}{4\pi \times K}} \tag{F.1}$$

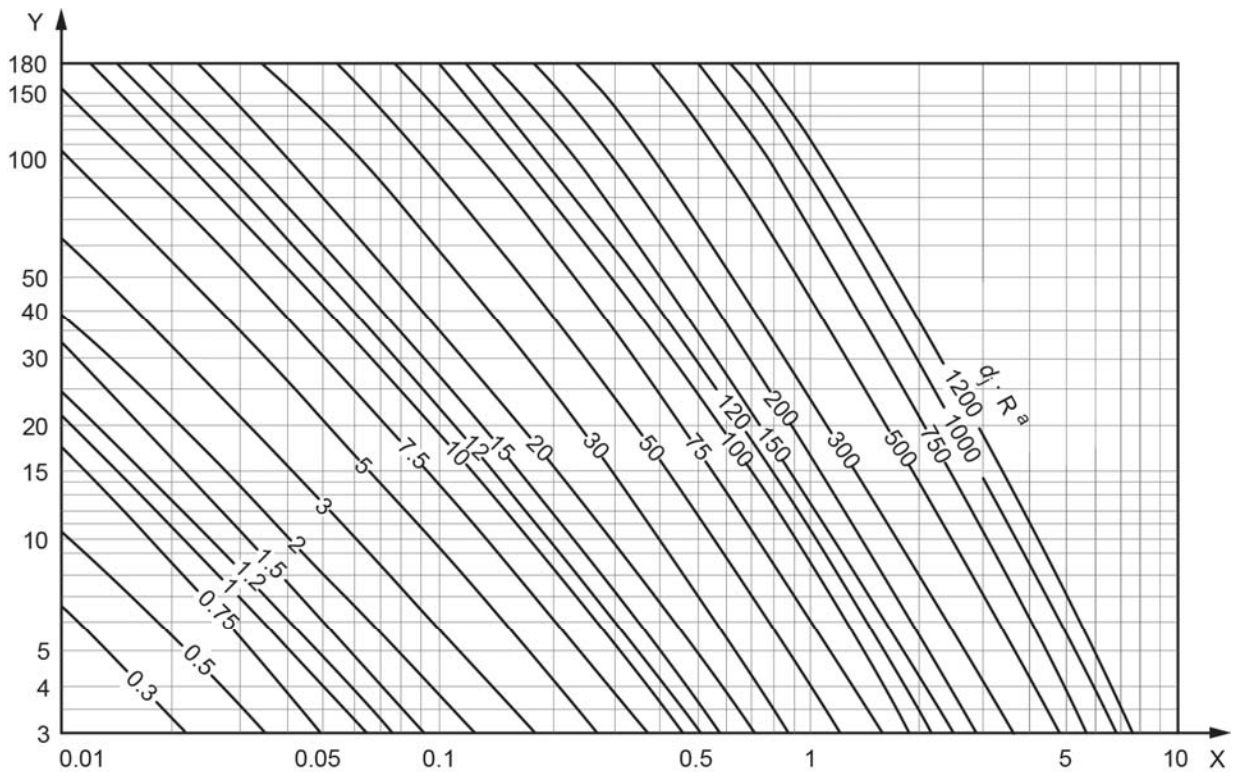

Key

X \bar{C}_L , the lower explosive limit concentration parameter for the flare gas, see Equation (C.8)

Y x_c , horizontal distance from the stack to flame center, expressed in meters

^a $(d_j \cdot R)$ is the parameter for jet thrust and wind thrust, see Equation (C.9)

Figure C.3—Flame Center for Flares and Ignited Vents—Horizontal Distance, x_c (SI Units)

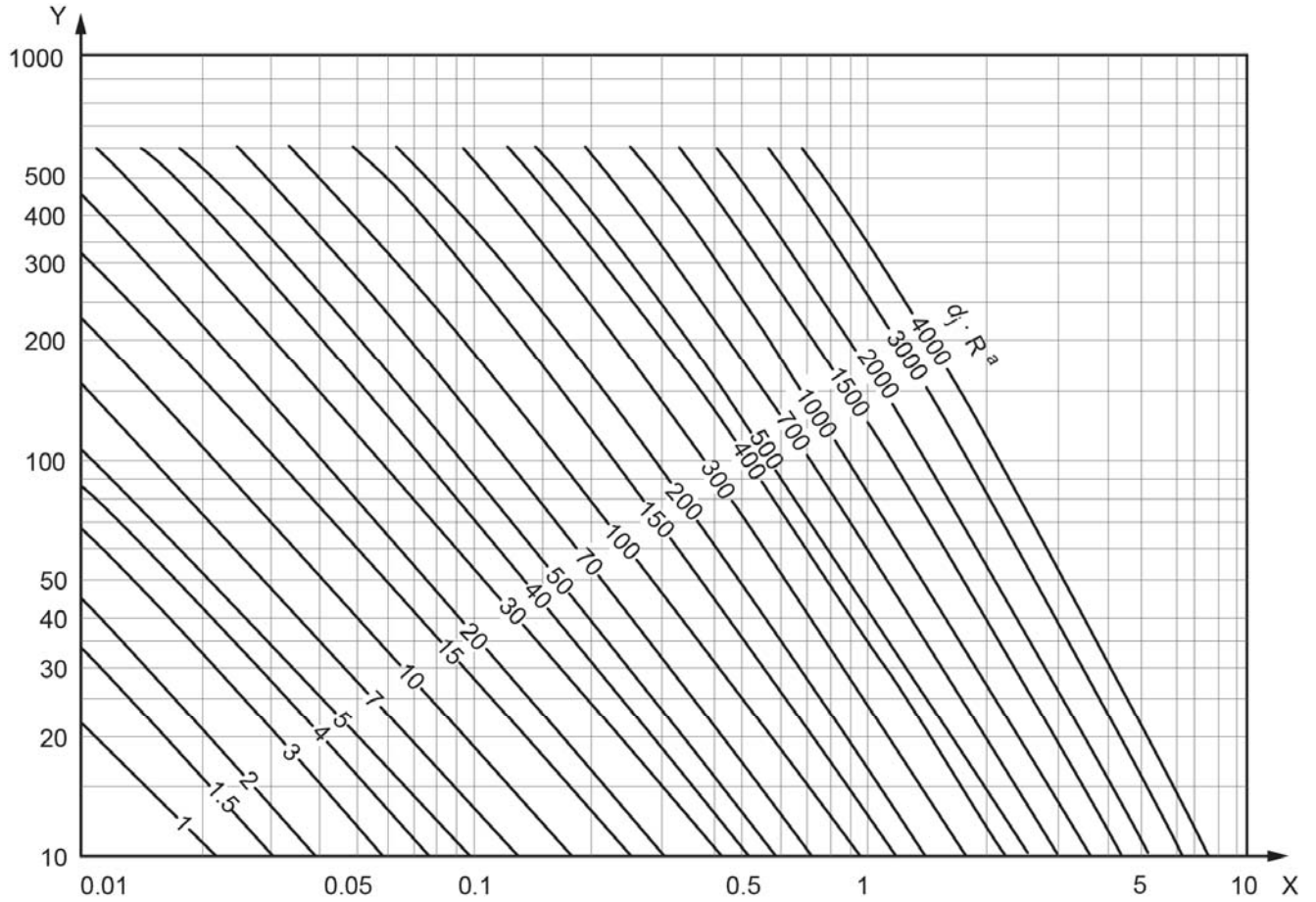

Key

X \overline{C}_L , the lower explosive limit concentration parameter for the flare gas, see Equation (C.8)

Y x_c , horizontal distance from the stack to flame center, expressed in meters

^a ($d_j \cdot R$) is the parameter for jet thrust and wind thrust, see Equation (C.9)

Figure C.4—Flame Center for Flares and Ignited Vents—Horizontal Distance, x_c (USC Units)

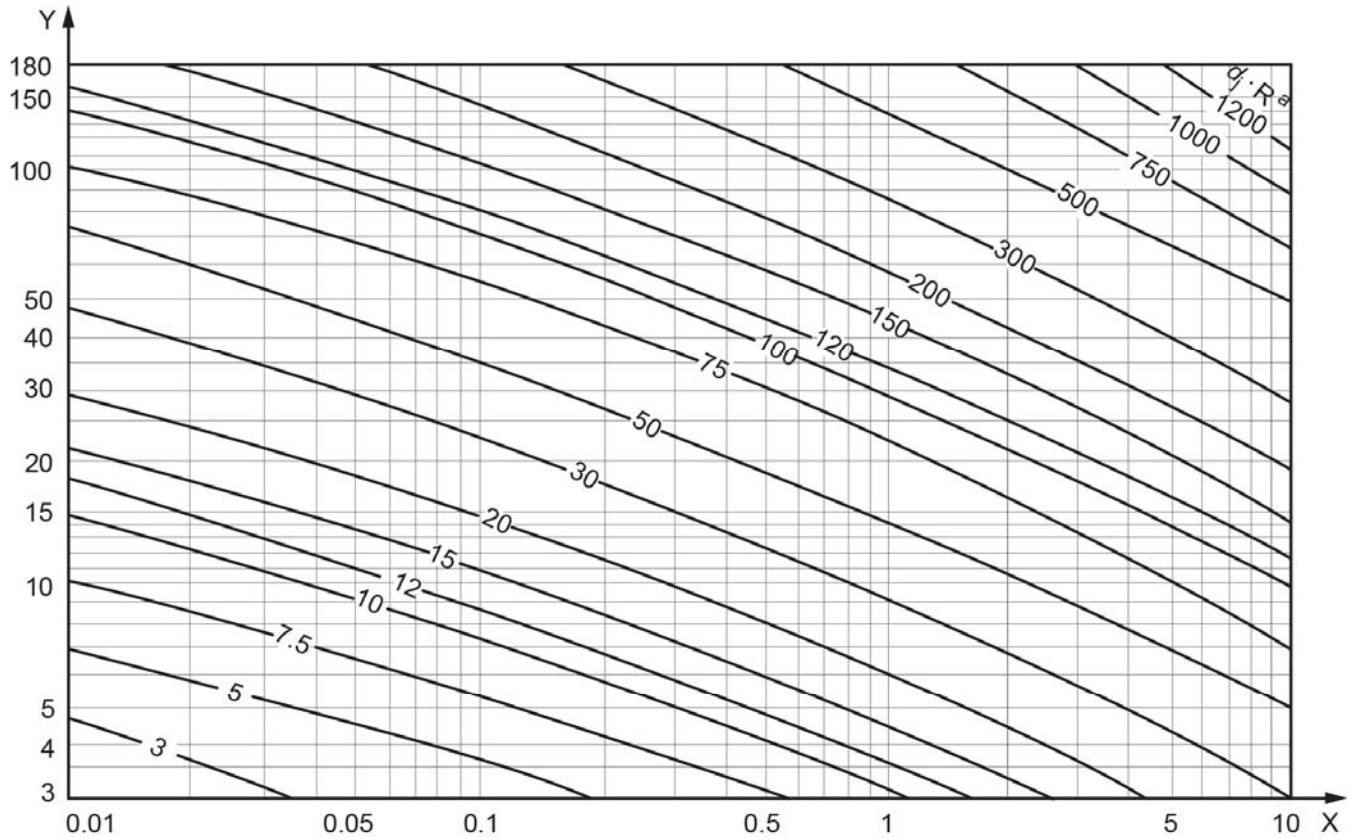
**Key**

X \overline{C}_L , the lower explosive limit concentration parameter for the flare gas, see Equation (C.8)

Y y_c , vertical distance from the flare tip to flame center, expressed in meters

^a $(d_j \cdot R)$ is the parameter for jet thrust and wind thrust, see Equation (C.9)

Figure C.5—Flame Center for Flares and Ignited Vents—Vertical Distance, y_c (SI Units)

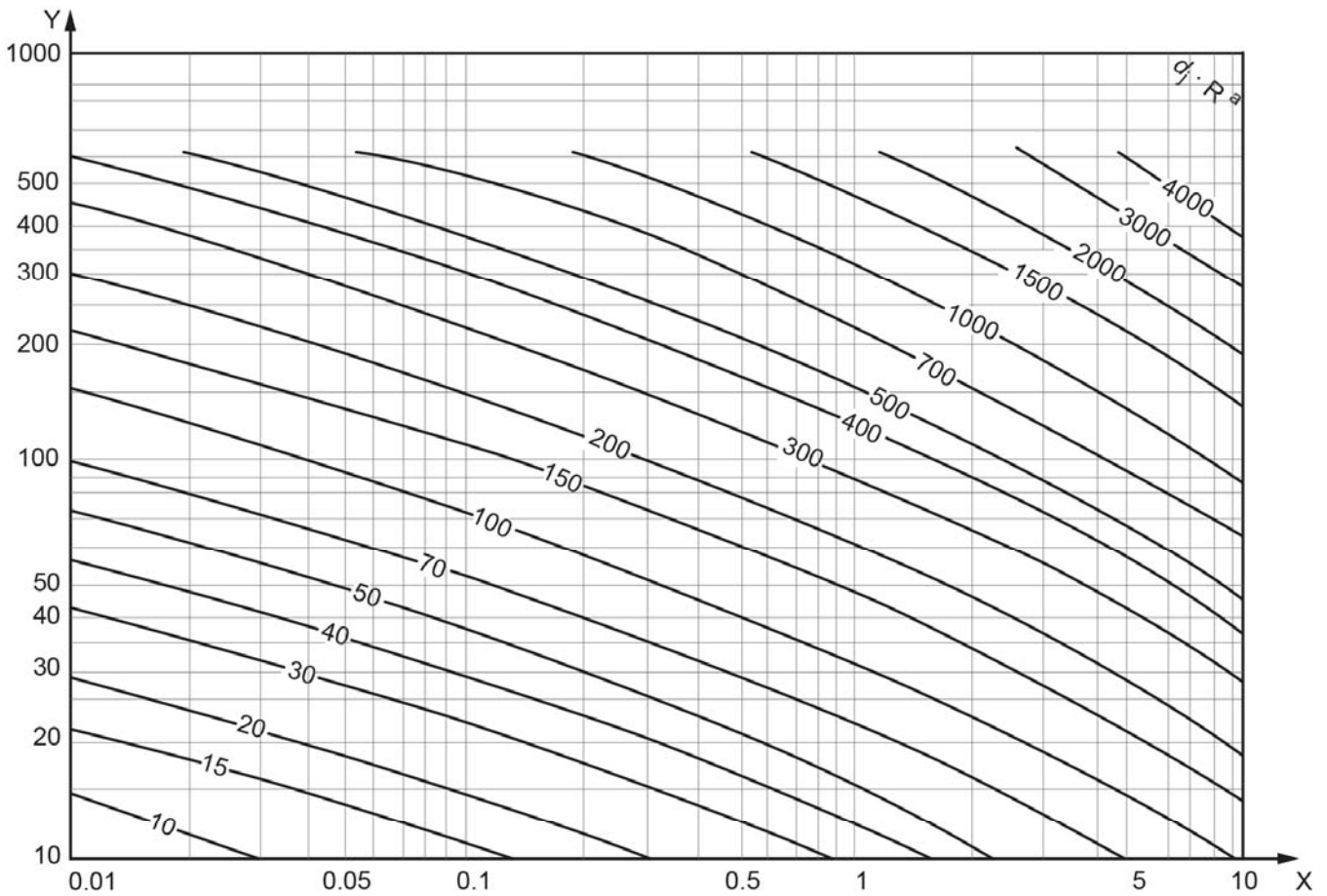

Key

X \overline{C}_L , the lower explosive limit concentration parameter for the flare gas, see Equation (C.8)

Y y_c , vertical distance from the flare tip to flame center, expressed in meters

^a ($d_j \cdot R$) is the parameter for jet thrust and wind thrust, see Equation (C.9)

Figure C.6—Flame Center for Flares and Ignited Vents—Vertical Distance, y_c (USC Units)

In SI units:

$$D = \sqrt{\frac{1.0 \times 0.3 \times 6.3 \times 10^6}{4\pi \times 9.5}} = 126 \text{ m}$$

In USC units:

$$D = \sqrt{\frac{1.0 \times 0.3 \times 2.15 \times 10^{10}}{4\pi \times 3000}} = 413 \text{ ft}$$

Thus, at a maximum allowable K of 9.5 kW/m² (3000 Btu/h·ft²), $D = 126 \text{ m}$ (413 ft) from the flame center.

Similarly, if the maximum allowable K is 6.3 kW/m² (2000 Btu/h·ft²), $D = 154 \text{ m}$ (507 ft) from the flame center.

C.2.3.5 Determination of Flare Stack Height

The limiting height of the flare stack depends on the design criteria selected and the facilities near the flare. At grade level, directly under the flame center, with K up to 9.5 kW/m^2 ($3000 \text{ Btu/h}\cdot\text{ft}^2$), the minimum flare stack height, h , is determined as follows.

In SI units:

$$\begin{aligned} h &= D - y_c \\ &= 126 - 30 = 96 \text{ m} \end{aligned}$$

In USC units:

$$\begin{aligned} h &= D - y_c \\ &= 413 - 100 = 313 \text{ ft} \end{aligned}$$

At grade level, at a radius, r , of 45.7 m (150 ft) from the base of the flare stack, with K limited to 6.3 kW/m^2 ($2000 \text{ Btu/h}\cdot\text{ft}^2$) and following the general arrangement shown in Figure C.2, h is determined as follows.

In SI units:

$$\begin{aligned} h' &= h + y_c \\ r' &= r - x_c \\ D^2 &= r'^2 + h'^2 = 154^2 \\ D^2 &= (r - x_c)^2 + (h + y_c)^2 \\ (h + 30)^2 &= 154^2 - (45.7 - 18)^2 = 22,949 \\ h &= 151 - 30 = 121 \text{ m} \end{aligned}$$

In USC units:

$$\begin{aligned} h' &= h + y_c \\ r' &= r - x_c \\ D^2 &= r'^2 + h'^2 = 507^2 \\ D^2 &= (r - x_c)^2 + (h + y_c)^2 \\ (h + 100)^2 &= 507^2 - (150 - 58)^2 = 248,585 \\ h &= 499 - 100 = 399 \text{ ft} \end{aligned}$$

C.2.3.6 Explanatory Notes

C.2.3.6.1 Lower Explosive Limits

Lower explosive limits for pure components may be obtained from AGA XK0101 [2] or from NFPA HAZ01 [128]. The lower explosive limits of mixtures may be calculated using Le Chatelier's rule as follows:

$$C_L = \left[\left(\frac{y_1}{C_{L1}} \right) + \left(\frac{y_2}{C_{L2}} \right) + \dots + \left(\frac{y_n}{C_{Ln}} \right) \right]^{-1} \quad (\text{C.10})$$

where

$C_{L1}, C_{L2}, \dots, C_{Ln}$ is the lower explosive concentration (i.e. lower flammable limit) of the component 1, 2, ..., n in air;

y_1, y_2, \dots, y_n is the mole fraction (or volume fraction) of the component 1, 2, ..., n in the mixture.

C.2.3.6.2 Brzustowski and Sommer Figures

The graphs in Figure C.3, Figure C.4, Figure C.5, and Figure C.6 are based on two independent variables, C_L and a modified form of $(d_j \times R)$. The variable $(d_j \times R)$ was modified (from that proposed in the Brzustowski and Sommer article [36]) to include gas and air temperatures and relative molecular masses instead of densities. The ideal gas law was assumed. Some adjustments were made in the graph curves over the C_L range from 0.5 to 1.5 to smooth out discontinuities. No significant difference, compared with hand calculated results, is introduced with the data smoothing. See the original article for the details of the hand calculation procedure.

C.2.3.6.3 Brzustowski and Sommer Atmospheric Attenuation

Brzustowski and Sommer recommend the use of the fraction of heat intensity transmitted, τ , to correct the radiation impact. The following is quoted from the original article [36]:

In the case of flares, atmospheric absorption attenuates K by about 10 % to 20 % over distances of 150 m (500 ft). The empirical Equations (C.11) and (C.12) are obtained by cross-plotting absorptivities calculated from the Hottel charts. It is strictly applicable only when a luminous, hydrocarbon flame is radiating at 1227 °C (2240 °F), the dry bulb ambient temperature is 27 °C (80 °F), the relative humidity is more than 10 %, and the distance from the flame is between 30 m and 150 m (100 ft and 500 ft); however, the equation can be used to estimate the order of magnitude of τ under a wider range of conditions.

In SI units:

$$\tau = 0.79 \left(\frac{100}{R_H} \right)^{1/16} \left(\frac{30}{D} \right)^{1/16} \quad (\text{C.11})$$

In USC units:

$$\tau = 0.79 \left(\frac{100}{R_H} \right)^{1/16} \left(\frac{100}{D} \right)^{1/16} \quad (\text{C.12})$$

where

τ is the fraction of K transmitted through the atmosphere;

R_H is the relative humidity, expressed as a percentage;

D is the distance from the flame to the illuminated area, expressed in m (ft).

Equation (C.11) and Equation (C.12) should prove adequate for most flare gases, except H_2 and H_2S , which burn with little or no luminous radiation. If the anticipated design conditions are very different from those under which Equation (C.11) and Equation (C.12) were derived, the designer should revert to the Hottel charts.

C.2.3.6.4 Steam Injection

Where steam injection is used at a rate of about 0.3 kg (0.7 lb) of steam per kg (lb) of flare gas, then the fraction of heat radiated, F , is decreased by 20 %.

C.3 Flare Knockout Drum

The following sample calculations have been limited to the simplest of the designs [5.7.8.2 a) and 5.7.8.2 b) drum configurations]. The calculations for 5.7.8.2 d) and 5.7.8.2 e) drum configurations are similar, with one-half the flow rate determining one-half the vessel length. The normal calculations are used for 5.7.8.2 c) drum configuration and are not duplicated here.

The following conditions are assumed.

- A single contingency results in the flow of 25.2 kg/s (200,000 lb/h) of a fluid with a liquid density of 496.6 kg/m³ (31 lb/ft³) and a vapor density of 2.9 kg/m³ (0.18 lb/ft³), both at flowing conditions.
- The gauge pressure is 13.8 kPa (2 psi), and the temperature is 149 °C (300 °F).
- The viscosity of the vapor is 0.01 mPa·s (0.01 cP).
- The fluid equilibrium results in 3.9 kg/s (31,000 lb/h) of liquid and 21.3 kg/s (169,000 lb/h) of vapor.

In addition, 1.89 m³ (500 U.S. gal) of storage for miscellaneous drainings from the units is desired. The schematic in Figure C.7 applies. The droplet size selected as allowable is 300 μm (0.012 in.) in diameter.

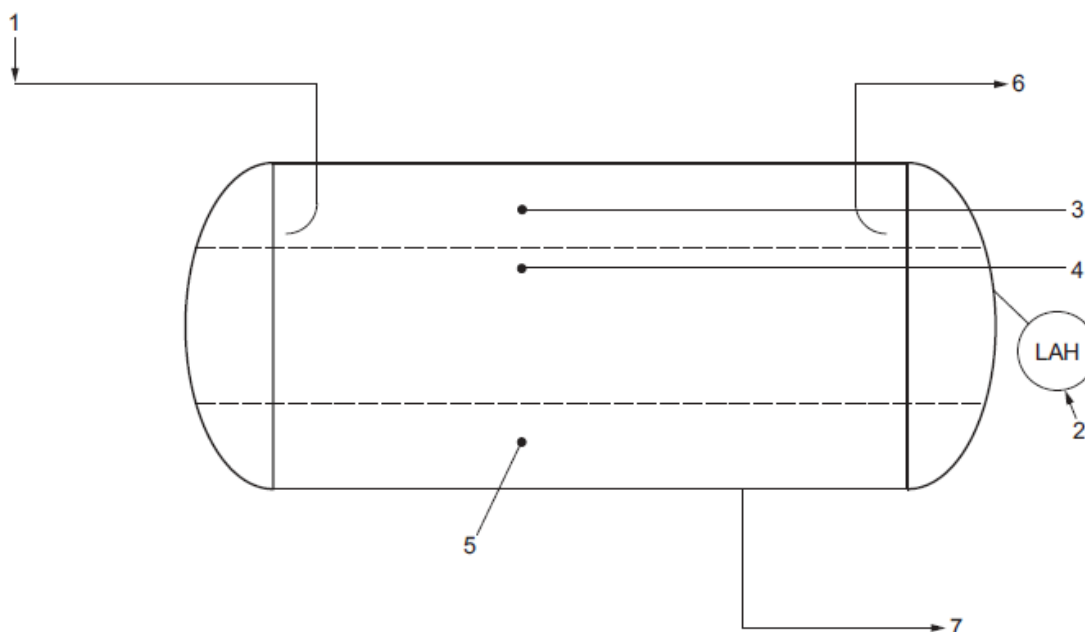

Key

- vapor and liquid pressure relief valve releases
- level instrument to indicate when the stipulated slop and drain volume becomes liquid full
- minimum vapor space for dropout velocity
- liquid holdup from pressure relief valves and other emergency releases
- slop and drain liquid
- to flare
- pump-out

Figure C.7—Flare Knockout Drum

The vapor rate, R_v , in actual m^3/s (ft^3/s), is determined as follows.

In SI units:

$$R_v = \frac{21.3}{2.9} = 7.34 \text{ m}^3/\text{s}$$

In USC units:

$$R_v = \frac{169,000}{3600 \times 0.18} = 261 \text{ ft}^3/\text{s}$$

The drag coefficient, C , is determined from Figure 5 using Equation (53) or Equation (54).

In SI units:

$$C(\text{Re})^2 = \frac{0.13 \times 10^8 \times 2.9 \times (0.0003)^3 \times (496.6 - 2.9)}{(0.01)^2} = 5025 \quad (53)$$

In USC units:

$$C(\text{Re})^2 = \frac{0.95 \times 10^8 \times 0.18 \times (0.000984)^3 \times (31 - 0.18)}{(0.01)^2} = 5021 \quad (54)$$

From Figure 5, $C = 1.3$.

A horizontal vessel with an inside diameter, D_i , and a cylindrical length, L , should be assumed. This gives the following total cross-sectional area, A_t :

$$A_t = \frac{\pi}{4} \cdot (D_i)^2 \quad (C.13)$$

Liquid holdup for a 30 min release from the single contingency, in addition to the slop and drain volume, is desired. The volume in the heads is neglected for simplicity. The liquid holdup required, A_{L1} in m^3 (ft^3), is calculated as follows.

The slop and drain volume of 1.89 m^3 (500 US gal, 66.8 ft^3) occupies a bottom segment as follows.

In SI units:

$$A_{L1} = 1.89 \left(\frac{1}{L} \right) \quad (C.14)$$

In USC units:

$$A_{L1} = 66.8 \left(\frac{1}{L} \right) \quad (C.15)$$

A total of 3.9 kg/s (31,000 lb/h) of condensed liquids with a density of 496.6 kg/m^3 (31 lb/ft^3) accumulated for 30 min occupies a cross-sectional segment as follows.

In SI units:

$$A_{L2} = \frac{3.9}{496.6} \times (30 \times 60) \left(\frac{1}{L} \right) \quad (C.16)$$

In USC units:

$$A_{L2} = \frac{31,000}{31} \times \frac{30}{60} \left(\frac{1}{L} \right) \quad (C.17)$$

The cross-sectional area remaining for the vapor flow is expressed as follows:

$$A_v = A_t - (A_{L1} + A_{L2}) \quad (\text{C.18})$$

The vertical depths of the liquid and vapor spaces are determined using standard geometry and the total drum diameter, h_t , calculated by Equation (C.19):

$$h_t = h_{L1} + h_{L2} + h_v \quad (\text{C.19})$$

where

h_{L1} is the depth of slops and drains;

$(h_{L1} + h_{L2})$ is the depth of all liquid accumulation;

h_v is the remaining vertical space for the vapor flow.

The adequacy of the vapor space is verified by determining the liquid dropout time, θ , using Equation (C.20) or Equation (C.21).

In SI units:

$$\theta = \left(\frac{h_v}{100} \right) \left(\frac{1}{u_c} \right) \quad (\text{C.20})$$

In USC units:

$$\theta = \left(\frac{h_v}{12} \right) \left(\frac{1}{u_c} \right) \quad (\text{C.21})$$

where

θ is the liquid dropout time, expressed in s;

h_v is the vertical drop available for liquid dropout, expressed in cm (in.);

u_c is the dropout velocity, expressed in m/s (ft/s).

The velocity of N vapor passes, based on one vapor pass, is determined from Equation (C.22) and Equation (C.23) for a volume flow rate of 7.34 m³/s (260 ft³/s).

In SI units:

$$u_v = \left(\frac{7.34}{N} \right) \left(\frac{1}{A_v} \right) \quad (\text{C.22})$$

In USC units:

$$u_v = \left(\frac{260}{N} \right) \left(\frac{1}{A_v} \right) \quad (\text{C.23})$$

where

A_v is the cross-sectional area, expressed in m^2 (ft^2);

N is the number of vapor passes;

u_v is the vapor velocity, expressed in m/s (ft/s).

The flow path length required, L_{min} , is determined as follows:

$$L_{min} = u_v \times \theta \times N \tag{C.24}$$

L_{min} shall be less than or equal to the above assumed flow path length (i.e. distance between the inlet and outlet nozzle), L ; otherwise, the calculation shall be repeated with a newly assumed flow path length.

Table C.1 and Table C.2 summarize the preceding calculations for one pass for horizontal drums with various inside diameters to determine the most economical drum size. Drum diameters in 15 cm (6 in.) increments are assumed, in accordance with standard head sizes. It can be concluded from Table C.1 and Table C.2 that:

- a) all of the drum sizes above fulfill the design requirements;
- b) the most suitable drum size should be selected according to the design pressure, material requirements, and corrosion allowance as well as layout, transportation, and other considerations;
- c) the choice of two-pass flow, as shown in Figure C.7, is optional.

Table C.1—Optimizing the Size of a Horizontal Knockout Drum (SI Units)

Trial No.	D_1^a	L^b	Cross-sectional Area m^2				Vertical Depth of Liquid and Vapor Spaces cm				θ^c	u_v^d	L_{min}^e
			A_t	A_{L1}	A_{L2}	A_v	h_{L1}	$h_{L1} + h_{L2}$	h_v	h_t			
1	2.44	5.79	4.67	0.33	2.45	1.89	30	140	104	244	1.45	3.9	5.6
2	2.29	6.25	4.10	0.30	2.27	1.53	29	137	91	229	1.28	4.8	6.2
3	2.13	6.86	3.57	0.28	2.07	1.22	28	133	81	213	1.13	6.0	6.7
4	1.98	7.62	3.08	0.25	1.86	0.98	27	128	70	198	0.98	7.5	7.4

NOTE 1 The data in this table are in accordance with the example given in text for one-pass vapor flow.

NOTE 2 The values in this table are rounded-off conversions of the values in Table C.2.

^a D_1 is the assumed drum inside diameter, expressed in meters.

^b L is the assumed drum cylindrical length, expressed in meters.

^c θ is the liquid dropout time, expressed in seconds.

^d u_v is the vapor velocity, expressed in meters per second.

^e L_{min} is the required flow path length, expressed in meters.

Table C.2—Optimizing the Size of a Horizontal Knockout Drum (USC Units)

Trial No.	D_1^a	L^b	Cross-sectional Area ft ²				Vertical Depth of Liquid and Vapor Spaces in.				θ^c	u_v^d	L_{min}^e
			A_t	A_{L1}	A_{L2}	A_v	h_{L1}	$h_{L1} + h_{L2}$	h_v	h_t			
1	8.0	19.0	50.26	3.52	26.32	20.43	11.75	55.0	41.0	96	1.45	12.76	18.5
2	7.5	20.5	44.17	3.26	24.39	16.52	11.43	54.0	36.0	90	1.28	15.78	20.2
3	7.0	22.5	38.49	2.97	22.22	13.29	11.00	52.3	31.7	84	1.13	19.62	22.1
4	6.5	25.0	33.18	2.67	20.00	10.51	10.5	50.4	27.6	78	0.98	24.82	24.3

NOTE The data in this table are in accordance with the example given in the text for one-pass vapor flow.

^a D_1 is the assumed drum inside diameter, expressed in feet.

^b L is the assumed drum cylindrical length, expressed in feet.

^c θ is the liquid dropout time, expressed in seconds.

^d u_v is the vapor velocity, expressed in feet per second.

^e L_{min} is the required flow path length, expressed in feet.

If a vertical vessel is considered, the vapor velocity is equal to the dropout velocity, which is 0.71 m/s (2.35 ft/s). The volume flow rate is 7.34 m³/s (260 ft³/s). The required cross-sectional area, A_{cs} , of the drum, in m² (ft²) is determined as follows.

In SI units:

$$A_{cs} = \frac{7.34}{0.71} = 10.3 \text{ m}^2 \quad (\text{C.25})$$

In USC units:

$$A_{cs} = \frac{260}{2.35} = 110.6 \text{ ft}^2 \quad (\text{C.26})$$

The drum diameter, D , is determined as follows.

In SI units:

$$D = \sqrt{10.3 \times \frac{4}{\pi}} = 3.6 \text{ m} \quad (\text{C.27})$$

In USC units:

$$D = \sqrt{110.6 \times \frac{4}{\pi}} = 11.9 \text{ ft} \quad (\text{C.28})$$

C.4 Sizing a Vent Stack

For this calculation, the following conditions should be assumed: The maximum-relief rate, \dot{m} , is 31.5 kg/s (250,000 lb/h). The relative molecular mass of the vapor, M , is 44. The absolute temperature of the vapor just inside the exit point from the vent stack, T , is 361 K (650 °R). The exit velocity, v , is 150 m/s (500 ft/s). The absolute pressure of the vapor just inside the exit point from the vent stack, p , is 101 kPa (14.7 psi). The gas constant, R , is 8.3 in SI units (10.7 in USC units). The density, ρ , is then calculated as in Equation (C.29) or Equation (C.30).

In SI units:

$$\rho = \frac{M \times p}{R \times T} = \frac{44 \times 101}{8.3 \times 361} = 1.48 \text{ kg/m}^3 \quad (\text{C.29})$$

In USC units:

$$\rho = \frac{M \times p}{R \times T} = \frac{44 \times 14.7}{10.7 \times 650} = 0.1 \text{ lb/ft}^3 \quad (\text{C.30})$$

The tip area, A_T , is determined by Equation (C.31) and Equation (C.32).

In SI units:

$$A_T = \frac{\dot{m}}{\rho \times v} = \frac{31.5}{1.48 \times 150} = 0.14 \text{ m}^2 \quad (\text{C.31})$$

In USC units:

$$A_T = \frac{\dot{m}}{3600 \rho \times v} = \frac{250,000}{3600 \times 0.1 \times 500} = 1.39 \text{ ft}^2 \quad (\text{C.32})$$

Thus, the pipe diameter should be approximately DN 400 (NPS 16).

C.5 Noise Calculation

C.5.1 Noise Calculation Example in SI Units

The noise level at 30 m (100 ft) from the point of discharge to the atmosphere can be calculated in SI units as follows.

- Calculate $(0.5q_m \times c^2)$ in watts.
- Calculate $10 \times \lg(0.5q_m \times c^2)$.
- In Figure 11, find the value of PR on the abscissa and read the corresponding ordinate.
- Add Items b) and c) to obtain $L_{30(100)}$, which is the average sound pressure level at 30 m (100 ft), expressed in decibels.

Consider the following relieving scenario:

- $q_m = 14.6 \text{ kg/s}$;
- $k = 1.4$;
- $M = 29$;
- $T = 311 \text{ K}$;
- inlet pressure to the relief device during the relieving event = 330 kPa;
- downstream pressure = atmospheric = 101 kPa.

Then:

$$PR = \text{pressure ratio} = 330/101 = 3.3;$$

$$c = 91.2 \times \left(\frac{1.4 \times 311}{29} \right)^{0.5} = 353 \text{ m/s} \quad (\text{C.33})$$

The results are as follows, referring to the numbered list items:

- a) $(0.5q_m \times c^2) = (0.5)(14.6)(353)^2 = 910,000$;
- b) $10 \times \lg(0.5q_m \times c^2) = 60$;
- c) from Figure 11, the ordinate corresponding to $PR = 3.3$ is 54;
- d) $L_{30(100)} = 54 + 60 = 114 \text{ dB}$.

C.5.2 Noise Calculation Example in USC Units

The noise level at 30 m (100 ft) from the point of discharge to the atmosphere can be calculated in USC units as follows.

- a) Calculate $(0.5q_m \times c^2)$ in watts as follows: Divide the mass flow (lb/s) by 32.2 ft-lb/lbf-s² to obtain q_m . Multiply $(0.5q_m \times c^2)$ feet times pound-force per second by 1.36.
- b) Calculate $10 \times \lg(0.5q_m \times c^2)$.
- c) In Figure 11, find the value of PR on the abscissa and read the corresponding ordinate.
- d) Add Items b) and c) to obtain $L_{30(100)}$, which is the average sound pressure level at 30 m (100 ft), expressed in decibels.

Assume the following:

- a) mass flow = 32.2 lb/s;
- b) $q_m = (32.2 \text{ lb/s}) / (32.2 \text{ ft-lb/lbf-s}^2) = 1 \text{ ft-lbf/s}$;
- c) $k = 1.4$;
- d) $M = 29$;
- e) $T = 560 \text{ }^\circ\text{R}$;
- f) inlet pressure to the relief device during the relieving event = 48 psia;
- g) downstream pressure = atmospheric = 14.7 psia.

Then:

$$PR = \text{pressure ratio} = 48/14.7 = 3.3;$$

$$c = 223 \times \left(\frac{1.4 \times 560}{29} \right)^{0.5} = 1159 \text{ ft/s} \quad (\text{C.34})$$

The results in USC units are as follows, referring to the list items above:

- a) $(0.5q_m \times c^2) = (0.5)(1)(1159)^2(1.36) = 910,000;$
- b) $10 \times \lg(0.5q_m \times c^2) = 60;$
- c) from Figure 11, the ordinate corresponding to $PR = 3.3$ is 54;
- d) $L_{30(100)} = 54 + 60 = 114 \text{ dB}.$

C.6 Fire Calculations

C.6.1 General

Pool fire test data can be used to illustrate fire calculations involving the Annex A analytical method as well as comparing the Annex A analytical method with the API empirical method in 4.4.13.2.4.2. The following are three large-scale pool fire tests from which data were used:

- a) 1943 Rubber Reserve Corporation (API fire test) fuel oil pool fire test (open pool fire) involving exposure of a vessel containing water [80, 143];
- b) 1974 Ballistic Research Laboratory (BRL) jet fuel pool fire test (partially confined pool fire) involving exposure of a rail tank car containing LPG [29];
- c) 1999 Federal Institute for Materials Research and Testing (BAM) fuel oil pool fire test (partially confined pool fire) involving exposure of a rail tank car containing LPG [32, 112].

C.6.2 Use of the Analytical Method to Reproduce API Fire Test Data

The API fire test involved an open pool fire. It was used as the basis for the API empirical method as discussed in A.2. Equation (A.1) can be used to reproduce the API fire test data shown in Plate 2 of Figure 1 using the parameters defined in the "observed" column of Table C.3. These parameters are shown for illustration purposes as there are other combinations that can reproduce the Plate 2 curve. Figure C.8 shows the comparison. The specified fire temperature of 1177 K (2120 °R) along with the other parameters in Table C.3 for the "observed" column results in an fire heat flux (q_{fire}) of 93.9 kW/m² (29,800 Btu/h·ft²) and an absorbed heat flux (q_{absorbed}) of 75.9 kW/m² (22,400 Btu/h·ft²). Note that the 1177 K (2120 °R) fire temperature is also used when determining fire insulation requirements (see 4.4.13.2.7).

Table C.3—Equation (A.1) Parameters Used to Reproduce Curves in Figure 1

Equation (A.1) Parameter	Figure 1, Plate 2 (Observed, i.e. Test Data)	Figure 1, Plates 1, 3, and 4
ϵ_{fire}	0.7	0.75
$\epsilon_{\text{surface}}$	0.7	0.75
α_{surface}	0.7	0.75
h	20 W/m ² ·K (3.52 Btu/h·ft ² ·°R)	20 W/m ² ·K (3.52 Btu/h·ft ² ·°R)
T_{gas}	1177 K (904 °C) 2119 °R (1660 °F)	1273 K (1000 °C) 2292 °R (1832 °F)
T_{fire}	1177 K (904 °C) 2119 °R (1660 °F)	1273 K (1000 °C) 2292 °R (1832 °F)
T_{surface}	Initially 294 K (21 °C) 529 °R (69 °F)	Initially 294 K (21 °C) 529 °R (69 °F)
q_{fire} (see NOTE 1)	93.9 kW/m ² (29,800 Btu/h·ft ²)	131 kW/m ² (41,700 Btu/h·ft ²)
q_{absorbed} (see NOTE 2)	75.9 kW/m ² (22,400 Btu/h·ft ²)	111 kW/m ² (32,700 Btu/h·ft ²)

NOTE 1 The fire heat flux is found by ignoring the reradiation (by setting $\epsilon_{\text{surface}} = 0$), setting $\alpha_{\text{surface}} = 1$, and setting the equipment temperature < 323 K (582 °R).

NOTE 2 The absorbed heat flux at start of fire.

The curves represented by the calculated curves shown in Plates 1, 3, and 4 of Figure 1 can be obtained with Equation (A.1) and a slightly different set of parameters as shown in Table C.3. These parameters result in a fire heat flux (q_{fire}) of 131 kW/m² (41,700 Btu/h·ft²) and an absorbed heat flux (q_{absorbed}) of 111 kW/m² (32,700 Btu/h·ft²). A comparison of the analytical model results with Figure 1, Plate 1, 3, and 4 curves is shown in Figure C.9.

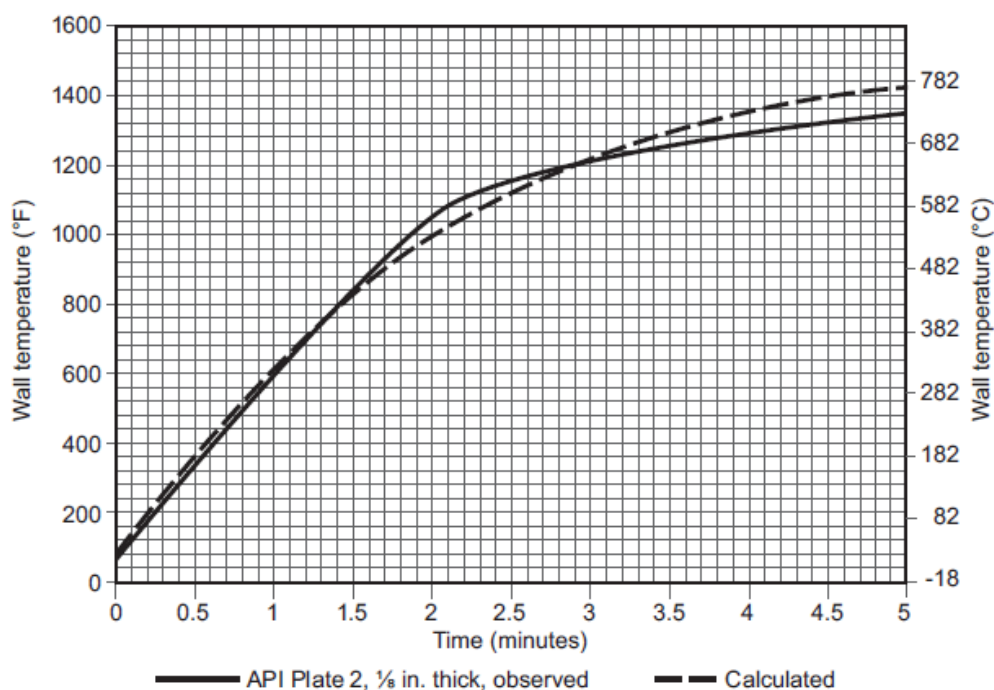

Figure C.8—Use of the Analytical Method to Reproduce API Fire Test Data (See Plate 2 of Figure 1)

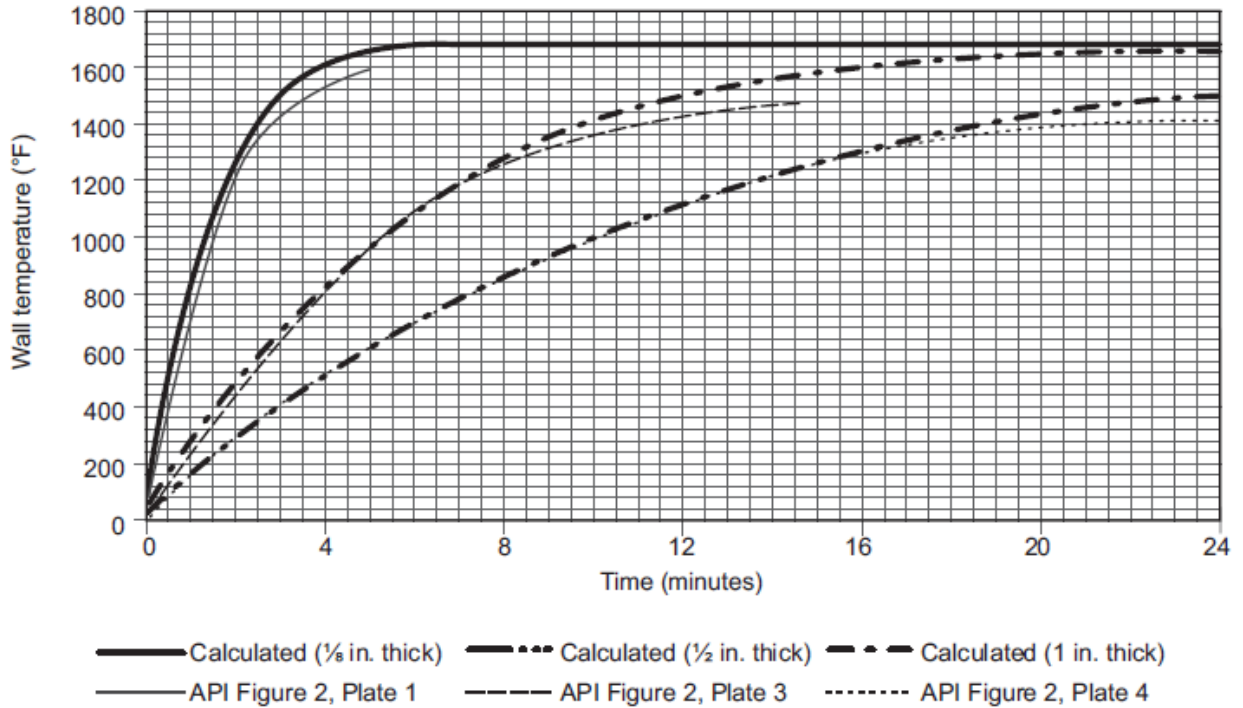

Figure C.9—Use of the Analytical Method to Reproduce API Figure 1, Plates 1, 3, and 4

C.6.3 Use of the Analytical Method to Reproduce BRL Fire Test Data

In 1974, the BRL in the United States investigated the effects of a pool fire on a partway filled rail tank car containing LPG [29]. The tank car was fabricated from TC-128 carbon steel and was protected by a PRV set at 18.6 barg (270 psig). The nominal capacity was 125 m³ (33,000 gal) with dimensions of 18.41 m (60.41 ft) long, 3.05 m (10 ft) diameter, and a shell wall thickness of 15.9 mm (0.625 in). The tank car was filled to 98 volume % with LPG (98 % propane, 2 % ethane, trace others) and was exposed to an engulfing-type JP-4 pool fire with dimensions of 24.4 m (80 ft) by 9.1 m (30 ft). The test area was within a pit measuring 45.7 m (150 ft) in length, 30.5 m (100 ft) in width, and 7.92 m (26 ft) in depth. Hence, this pool fire is considered to be partially confined because there are adjacent embankments on all sides with a height taller than the tank car. The test lasted for 24.5 min at which time the tank car ruptured reportedly at the top rear shell wall due to overheating. The pressure at the time of rupture was 335 psig (124 % of the set pressure) and slowly decreasing.

Fire and wall temperatures versus time at the top of the front and rear walls of the tank car are shown in Figure C.10 and Figure C.11, respectively. Equation (A.1) was used in an attempt to reproduce the wall temperature versus time for these center locations in the BRL fire test with the parameters in Table C.4. A constant fire temperature was used along with a fire emissivity of 0.62 as determined by BRL. The results are shown in Figure C.12. It should be noted that the BRL tests indicated that there was some stratification [~15 °C (22 °F)] in the liquid until the PRV remained open at which time the liquid temperature became uniform throughout. This indicates that nonequilibrium conditions occur during the initial heat-up period.

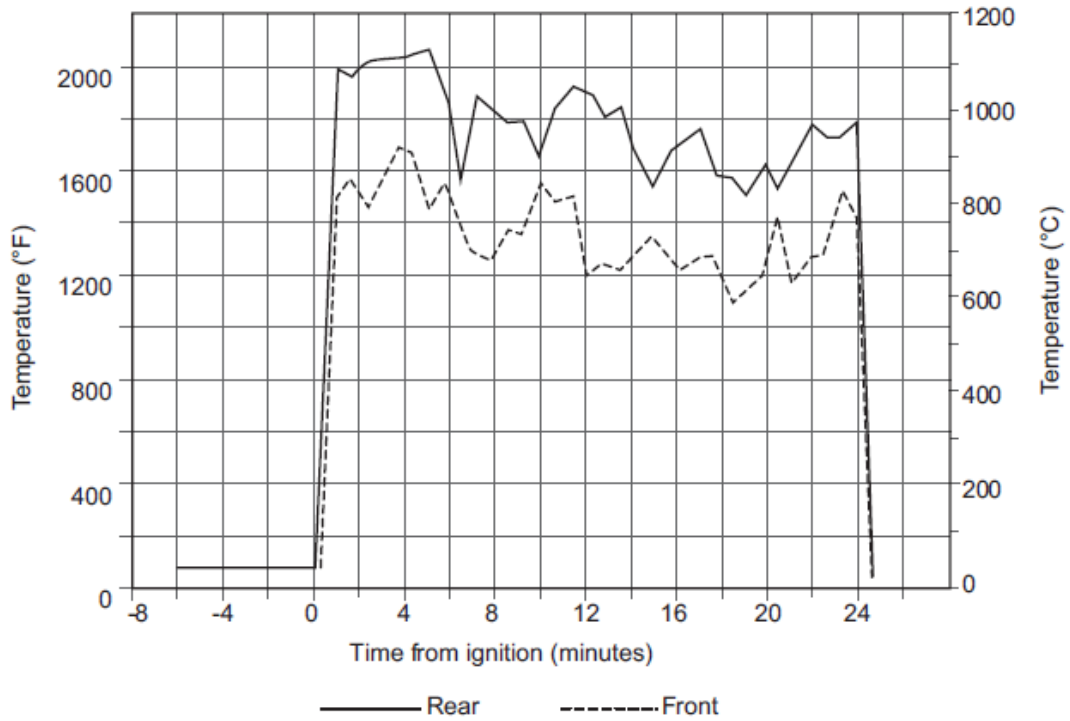

Figure C.10—BRL Test Data Illustrating Fire Temperature vs Time at the Top of the Front and Rear Walls of a Rail Tank Car Containing LPG and Exposed to a JP-4 Pool Fire ^[29]

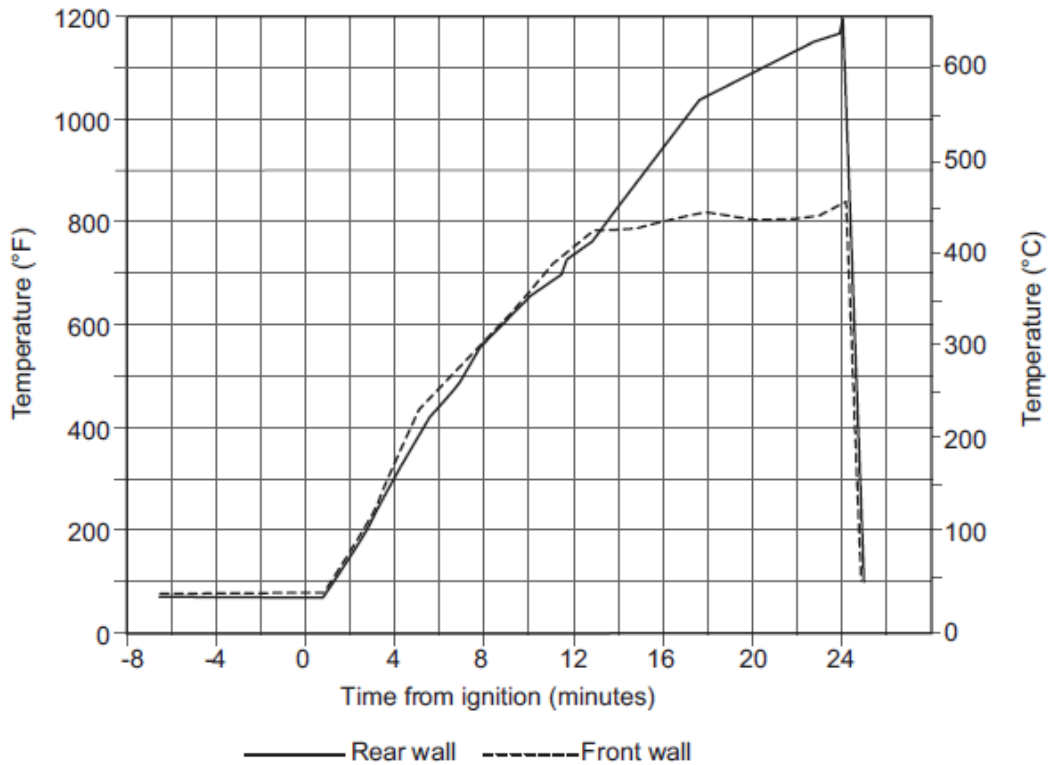

Figure C.11—BRL Test Data Illustrating Wall Temperature vs Time at the Top of the Front and Rear Walls of a Rail Tank Car Containing LPG and Exposed to a JP-4 Pool Fire ^[29]

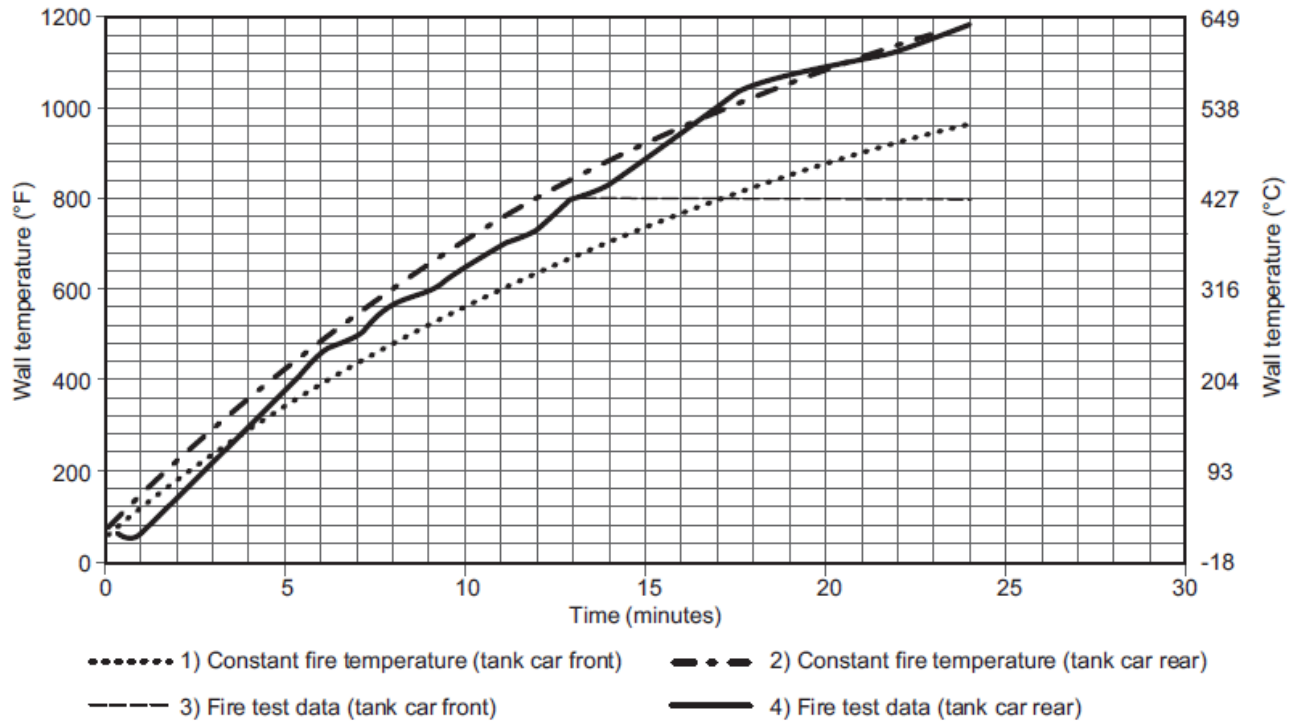

Figure C.12—Use of the Analytical Method to Reproduce BRL Fire Test Data (Constant Fire Temperature)

Table C.4—Equation (A.1) Parameters Used to Reproduce BRL Fire Test Data for the Rail Tank Car Top Front and Rear Wall Temperatures vs Time

Equation (A.1) Parameter	Front Wall	Rear Wall
ϵ_{fire}	0.62	0.62
$\epsilon_{\text{surface}}$	0.5	0.5
α_{surface}	0.5	0.5
h	10 W/m ² ·K (1.76 Btu/h·ft ² ·°R)	10 W/m ² ·K (1.76 Btu/h·ft ² ·°R)
T_{gas}	1073 K (800 °C) 1932 °R (1472 °F)	1173 K (900 °C) 2112 °R (1652 °F)
T_{fire}	1073 K (800 °C) 1932 °R (1472 °F)	1173 K (900 °C) 2112 °R (1652 °F)
T_{surface}	Initially at 294 K (21 °C) 529 °R (69 °F)	Initially at 294 K (21 °C) 529 °R (69 °F)
q_{fire} (see NOTE 1)	54.4 kW/m ² (17,300 Btu/h·ft ²)	75.4 kW/m ² (23,900 Btu/h·ft ²)
q_{absorbed} (see NOTE 2)	30.9 kW/m ² (9800 Btu/h·ft ²)	41.9 kW/m ² (13,300 Btu/h·ft ²)

NOTE 1 The fire heat flux is found by ignoring the reradiation (by setting $\epsilon_{\text{surface}} = 0$), setting $\alpha_{\text{surface}} = 1$, and setting the equipment temperature < 323 K (582 °R).

NOTE 2 The absorbed heat flux at start of fire.

C.6.4 Use of the Analytical Method to Reproduce BAM Fire Test Data

The Federal Institute for Materials Research and Testing (BAM) of Germany performed a test in 1999 to investigate the effects of a fire on a partway filled rail tank car containing LPG^[32, 112]. The rail tank car was fabricated from low-temperature carbon steel and had a test pressure of 28 bar (406 psig). The nominal capacity was 45.36 m³ (12,000 gal) with dimensions of 5.95 m (19.5 ft) T-T long, 2.9 m (9.5 ft) diameter, and wall thicknesses of 14.9 mm (0.587 in.) for the shell and 17.0 mm (0.669 in.) for the heads. The tank car contained about 10 m³ (2640 gal) of propane (22 % fill volume) and was exposed to an engulfing-type fuel oil pool fire with dimensions of 10 m (33 ft) by 5 m (16 ft). It was a partially confined pool fire because there was a U-shaped embankment adjacent to the rear and both sides with a height of 6 m (19.7 ft) (i.e. taller than the tank car).

Fire temperatures versus time for several locations around the tank car are shown in Figure C.13. The top three curves in this figure were obtained near the rear of the tank car in the center, left, and right locations, respectively reading from the top down. The bottom curves, taken at other locations around the tank car, had fire temperatures below 673 K (1212 °R) reportedly because the pool fire was not in an ideal enclosure (e.g. the pool fire was influenced by wind). Tank car wall temperatures versus time for several locations on the tank car are shown in Figure C.14. The top three curves in this figure were obtained at the top rear of the tank car in the center, left, and right locations, respectively. The other temperatures were taken at other locations around the tank car.

Although the test was conducted under controlled conditions, the fire temperatures and wall temperatures shown in Figure C.13 and Figure C.14 exhibit significant variability depending upon location within the pool fire. The effect of the partial confinement is illustrated by significantly higher fire and wall temperatures in the rear of the tank car that was adjacent to an embankment.

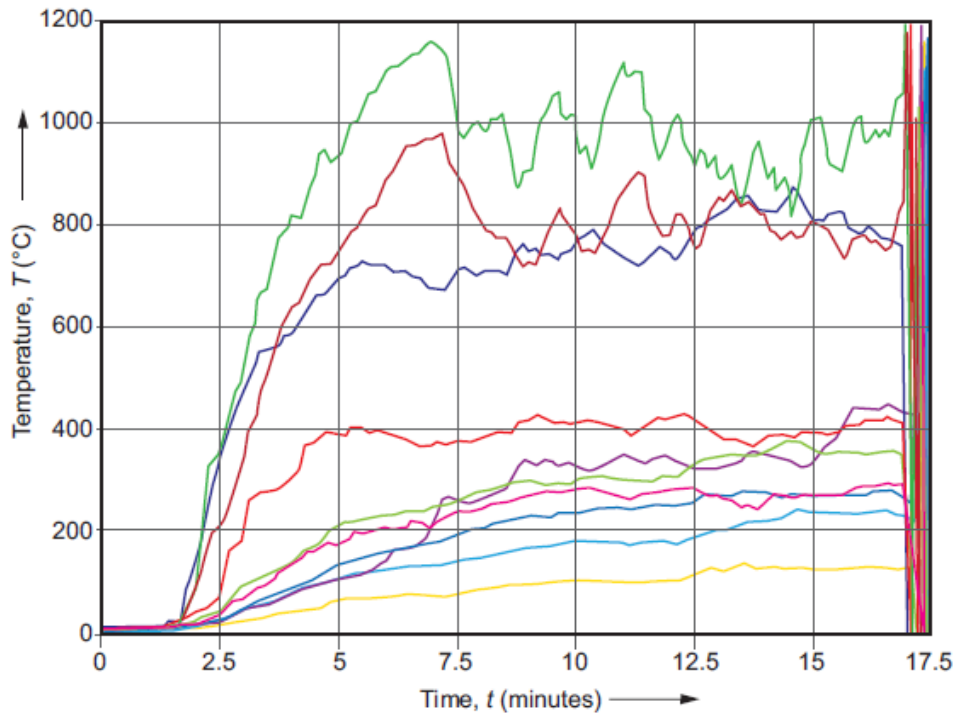

Figure C.13—BAM Test Data Illustrating Fire Temperature vs Time at Various Locations Around a Rail Tank Car Containing LPG and Exposed to a Fuel Oil Pool Fire^[112]

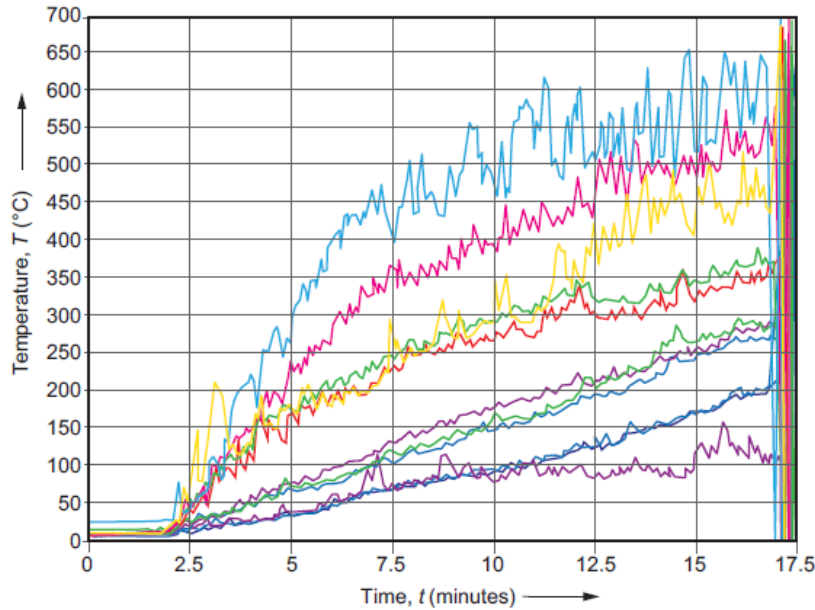

Figure C.14—BAM Test Data Illustrating Wall Temperature vs Time at Various Locations Around a Rail Tank Car Containing LPG and Exposed to a Fuel Oil Pool Fire ^[112]

Equation (A.1) was used in an attempt to approximate the wall temperature versus time for the top rear center location in the BAM fire test with the parameters in Table C.5.

Table C.5—Equation (A.1) Parameters Used to Reproduce BAM Fire Test Data for the Rear Locations of the Rail Tank Car Temperatures vs Time

Equation (A.1) Parameter	Modeled Using a Constant Fire Temperature			Modeled Using a Variable Fire Temperature		
	BAM Test—Rear Center Location	BAM Test—Rear Left Location	BAM Test—Rear Right Location	BAM Test—Rear Center Location	BAM Test—Rear Left Location	BAM Test—Rear Right Location
ϵ_{fire}	0.6	0.6	0.6	0.6	0.6	0.6
$\epsilon_{\text{surface}}$	0.5	0.65	0.4	0.75	0.75	0.75
α_{surface}	0.5	0.65	0.4	0.75	0.75	0.75
h	20 W/m ² ·K (3.52 Btu/h·ft ² ·°R)	20 W/m ² ·K (3.52 Btu/h·ft ² ·°R)	20 W/m ² ·K (3.52 Btu/h·ft ² ·°R)	30 W/m ² ·K (5.28 Btu/h·ft ² ·°R)	30 W/m ² ·K (5.28 Btu/h·ft ² ·°R)	30 W/m ² ·K (5.28 Btu/h·ft ² ·°R)
T_{gas}	Same as T_{fire}	Same as T_{fire}	Same as T_{fire}	Same as T_{fire}	Same as T_{fire}	Same as T_{fire}
T_{fire}	1273 K (1000 °C) 2292 °R (1832 °F)	1073 K (800 °C) 1932 °R (1472 °F)	1073 K (800 °C) 1932 °R (1472 °F)	448 K to 1423 K (175 °C to 1150 °C) 807 °R to 2562 °R (347 °F to 2102 °F)	448 K to 1148 K (175 °C to 875 °C) 807 °R to 2067 °R (347 °F to 1607 °F)	383 K to 1,098 K (110 °C to 825 °C) 690 °R to 1977 °R (230 °F to 1517 °F)
T_{surface}	Varies, Initially 294 K (21 °C) 529 °R (69 °F)	Varies, Initially 294 K (21 °C) 529 °R (69 °F)	Varies, Initially 294 K (21 °C) 529 °R (69 °F)	Varies, Initially 294 K (21 °C) 529 °R (69 °F)	Varies, Initially 294 K (21 °C) 529 °R (69 °F)	Varies, Initially 294 K (21 °C) 529 °R (69 °F)
Maximum q_{fire} (see NOTE)	109 kW/m ² (34,570 Btu/h·ft ²) (occurs at start of the fire)	60.7 kW/m ² (19,260 Btu/h·ft ²) (occurs at start of the fire)	60.7 kW/m ² (19,260 Btu/h·ft ²) (occurs at start of the fire)	174 kW/m ² (55,020 Btu/h·ft ²) (occurs 7 min after start of the fire)	110 kW/m ² (34,810 Btu/h·ft ²) (occurs 7 min after start of the fire)	73.6 kW/m ² (23,350 Btu/h·ft ²) (occurs 13 min after start of the fire)
Maximum q_{absorbed}	64.1 kW/m ² (20,320 Btu/h·ft ²) (occurs at start of the fire)	44.7 kW/m ² (14,160 Btu/h·ft ²) (occurs at start of the fire)	33.5 kW/m ² (10,610 Btu/h·ft ²) (occurs at start of the fire)	122 kW/m ² (38,780 Btu/h·ft ²) (occurs 7 min after start of the fire)	80.2 kW/m ² (25,410 Btu/h·ft ²) (occurs 7 min after start of the fire)	42.3 kW/m ² (13,410 Btu/h·ft ²) (occurs 13 min after start of the fire)

NOTE The fire heat flux is found by ignoring the reradiation (by setting $\epsilon_{\text{surface}} = 0$), setting $\alpha_{\text{surface}} = 1$, and setting the equipment temperature < 323 K (582 °R).

Two approaches were evaluated:

- 1) constant fire temperature, and
- 2) fire temperature varies with time based on extrapolations of Figure C.13 data.

The results are shown in Figure C.15 (variable fire temperature) and Figure C.16 (constant fire temperature). The results indicate that one set of values for the parameters in the Equation (A.1) will not fit the test data for the three locations (center, left, right) even though in proximity to one another (i.e. rear of the tank car). The significant variability in the pool fire makes it impossible to apply one set of values in Equation (A.1) to obtain representative results for the entire tank car. A comparison of Figure C.15 and Figure C.16 suggests that the simpler constant fire temperature assumption provides a reasonable approximation of the wall temperature versus time comparable to the variable fire temperature assumption. Note that other combinations of values for the parameters can be specified which would reproduce the test data equally or better than that shown in Figure C.15.

The preceding example used the fire data from the rear of the tank car. However, most of the tank car (i.e. locations in the middle and front) experienced significantly lower fire temperatures and, consequently, a lower rate of wall temperature rise and absorbed heat flux. For example, a constant F&G temperature of 673 K (1212 °R) (maximum of bottom curves in Figure C.13) along with the other parameter values in Table C.5 result in a maximum fire heat flux of 14.4 kW/m² (4560 Btu/h·ft²) and a maximum absorbed heat flux of 10.9 kW/m² (3450 Btu/h·ft²), which are both considerably lower than those for the rear locations shown in Table C.5.

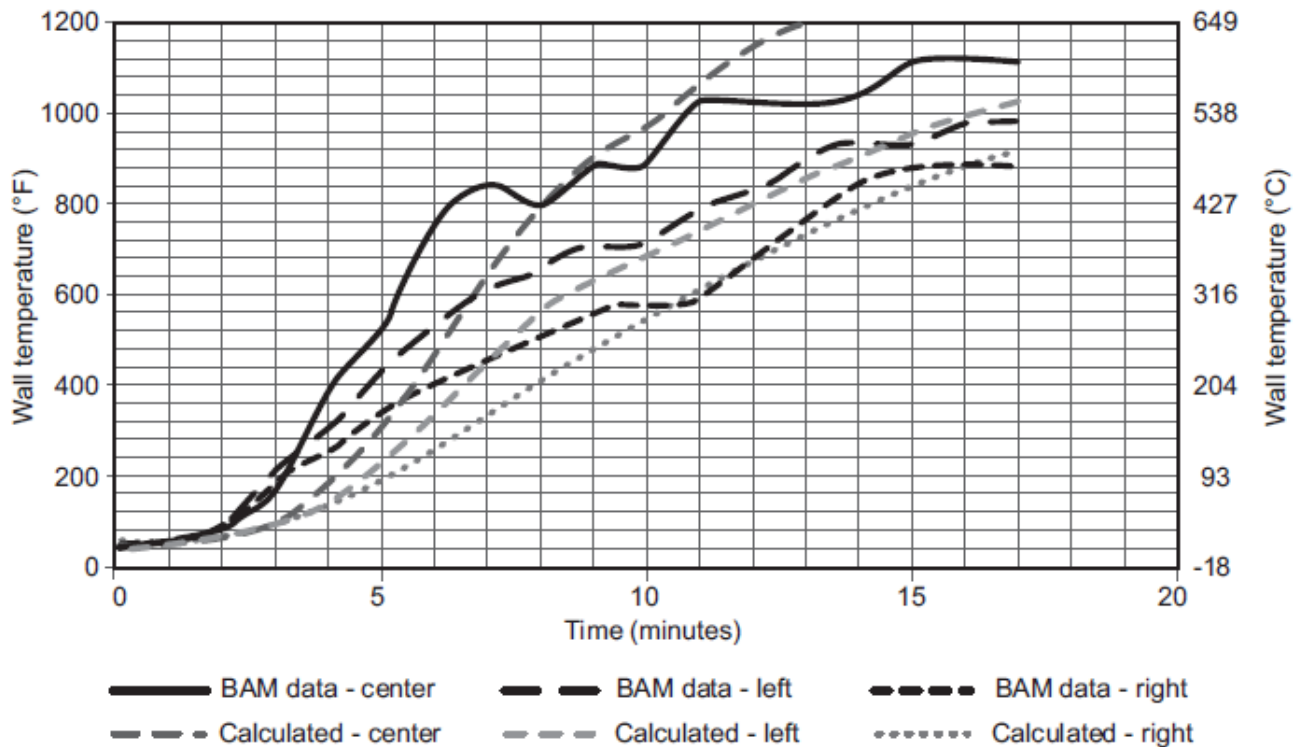

Figure C.15—Use of the Analytical Method to Reproduce BAM Fire Test Data (Variable Fire Temperature)

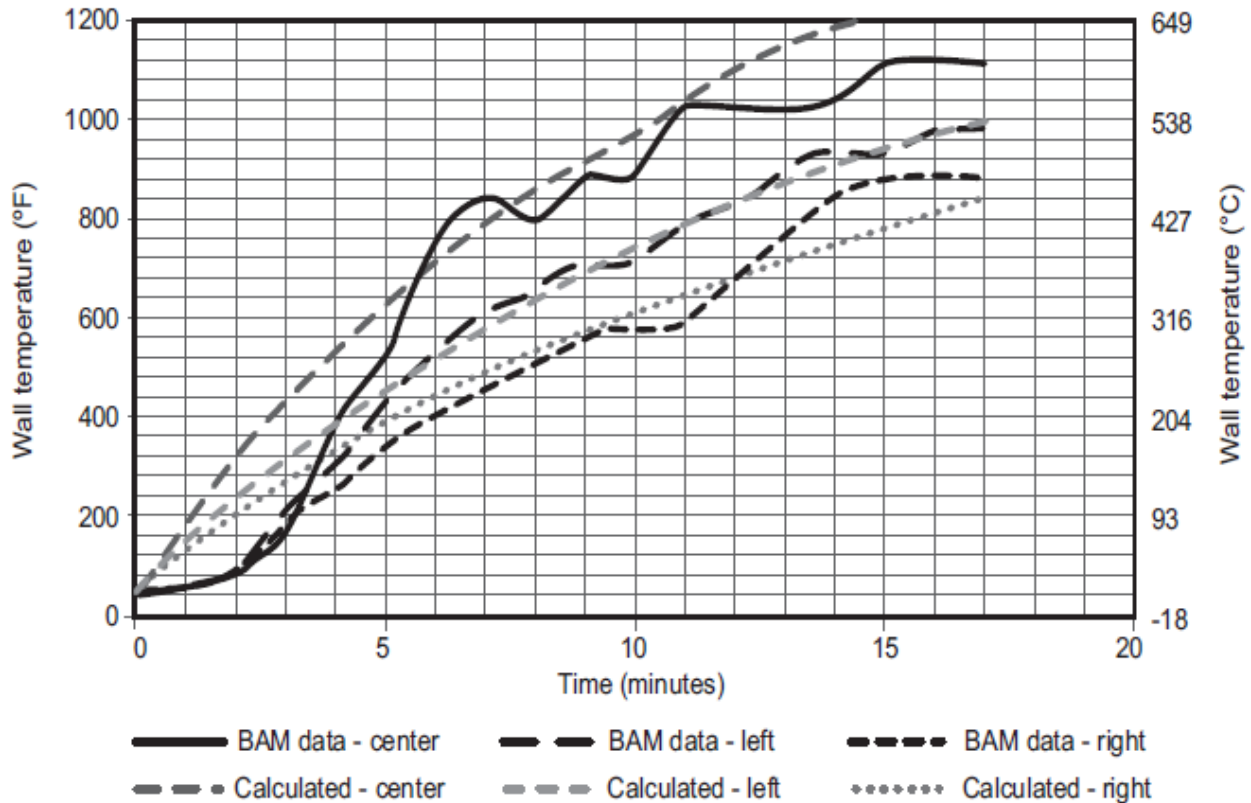

Figure C.16—Use of the Analytical Method to Reproduce BAM Fire Test Data (Constant Fire Temperature)

C.6.5 Comparison of the Analytical and Empirical Methods

C.6.5.1 Comparison of the Analytical and Empirical Methods Using the BAM Test Data

C.6.5.1.1 Comparison Using Total Absorbed Heat Calculated from the BAM Test Data

In order to compare the analytical method with the API empirical method (see 4.4.13.2.4.2), either an absorbed heat duty, a relief load, or a liquid temperature-versus-time profile based on the absorbed heat needs to be calculated with both methods using the pool fire test data. The BAM fire test discussed in C.6.4 provides sufficient data to allow the comparison between the analytical and empirical methods to be made using an absorbed heat duty. The API empirical method involved Equation (8) for inadequate drainage (i.e. fire test set up to have an engulfing pool fire), an environment factor of 1, and a wetted area of 23.16 m² (249 ft²) based on a 0.2 m (0.66 ft) liquid level (~22 % full) from the BAM test, 2:1 ellipsoidal heads, and neglecting liquid swell (i.e. expansion of liquid as it heats up). The analytical method applied the same wetted area as above but with a 1.0 exponent instead of a 0.82 exponent. The analytical method used data from the left, center, and right of the front and rear locations (six cases). The constant fire temperature parameters for the BAM test data were used (see Table C.5 for the rear left, center, and right data). In addition, arithmetic averages of the front (left, center, and right), the rear (left, center, and right), and all locations were calculated. The results are shown in Table C.6. The effect of the adjacent embankment is shown by the significantly higher heat inputs calculated for the rear location as compared with the front. This demonstrates the strong effect of wind on absorbed heat. The wind was about 2 m/s (4.5 mph) at the start but decreased during the test (blowing from the front right location). The total heat input calculated by the analytical method is about 77 % of that calculated with the API empirical method when all locations are averaged.

It is important to note that the BAM fire tests heat fluxes were based on data obtained at the top of the tank car, whereas significantly lower heat fluxes were experienced at the bottom.

C.6.5.1.2 Comparison Using Liquid Sensible Heating Calculated from the BAM Test Data

Although there was no relieving across the PRV during the BAM test, the liquid temperature-versus-time profile was determined at three different locations in the vessel (see Figure C.17). The temperatures are similar with only slight indications of stratification suggesting that bulk mixing of the liquid generally occurred throughout the test. The reported mean temperature rise was 4.48 °C/min (8.06 °F/min). Based on this temperature rise rate and assuming pure propane with the Peng-Robinson equation-of-state for liquid enthalpies results in a calculated heat input of 1115 kW (3.81 MBTU/h). This is 118 % of the 933 kW (2.73 MBTU/h) heat input calculated with the API empirical method (see C.6.5.1.1).

Table C.6—Comparison of Absorbed Heat Duties Calculated with the API Empirical and Analytical Method Applying the BAM Fire Test Data

Method	BAM Test Location	Maximum Fire Heat Flux	Maximum Absorbed Heat Flux	A_w Exponent	Total Heat Input	% of API Method (see NOTE)
API Empirical	NA	NA	70.9 kW/m ² (Btu/h·ft ²)	0.82	933 kW (2.73 MBtu/h)	100
Analytical	Rear left	60.7 kW/m ² (19,260 Btu/h·ft ²)	44.7 kW/m ² (14,160 Btu/h·ft ²)	1	1034 kW (3.53 MBtu/h)	111
Analytical	Rear center	109 kW/m ² (34,570 Btu/h·ft ²)	64.1 kW/m ² (20,320 Btu/h·ft ²)	1	1485 kW (5.07 MBtu/h)	159
Analytical	Rear right	60.7 kW/m ² (19,260 Btu/h·ft ²)	33.5 kW/m ² (10,610 Btu/h·ft ²)	1	775 kW (2.65 MBtu/h)	83
Analytical	Front left	44.1 kW/m ² (13,990 Btu/h·ft ²)	28.6 kW/m ² (9080 Btu/h·ft ²)	1	663 kW (2.26 MBtu/h)	71
Analytical	Front center	11.7 kW/m ² (3710 Btu/h·ft ²)	9.6 kW/m ² (3055 Btu/h·ft ²)	1	223 kW (0.76 MBtu/h)	24
Analytical	Front right	7.1 kW/m ² (2260 Btu/h·ft ²)	5.4 kW/m ² (1720 Btu/h·ft ²)	1	126 kW (0.43 MBtu/h)	14
Analytical	Rear average of left, center, right	76.8 kW/m ² (24,360 Btu/h·ft ²)	47.4 kW/m ² (15,030 Btu/h·ft ²)	1	1098 kW (3.75 MBtu/h)	118
Analytical	Front average of left, center, right	21.0 kW/m ² (6650 Btu/h·ft ²)	14.6 kW/m ² (4620 Btu/h·ft ²)	1	337 kW (1.15 MBtu/h)	36
Analytical	Average of rear and front	48.9 kW/m ² (15,510 Btu/h·ft ²)	31.0 kW/m ² (9825 Btu/h·ft ²)	1	718 kW (2.45 MBtu/h)	77

NOTE This is the total heat input divided by the API total heat input. A value greater than 100 % indicates that more heat is absorbed than calculated using the API empirical method.

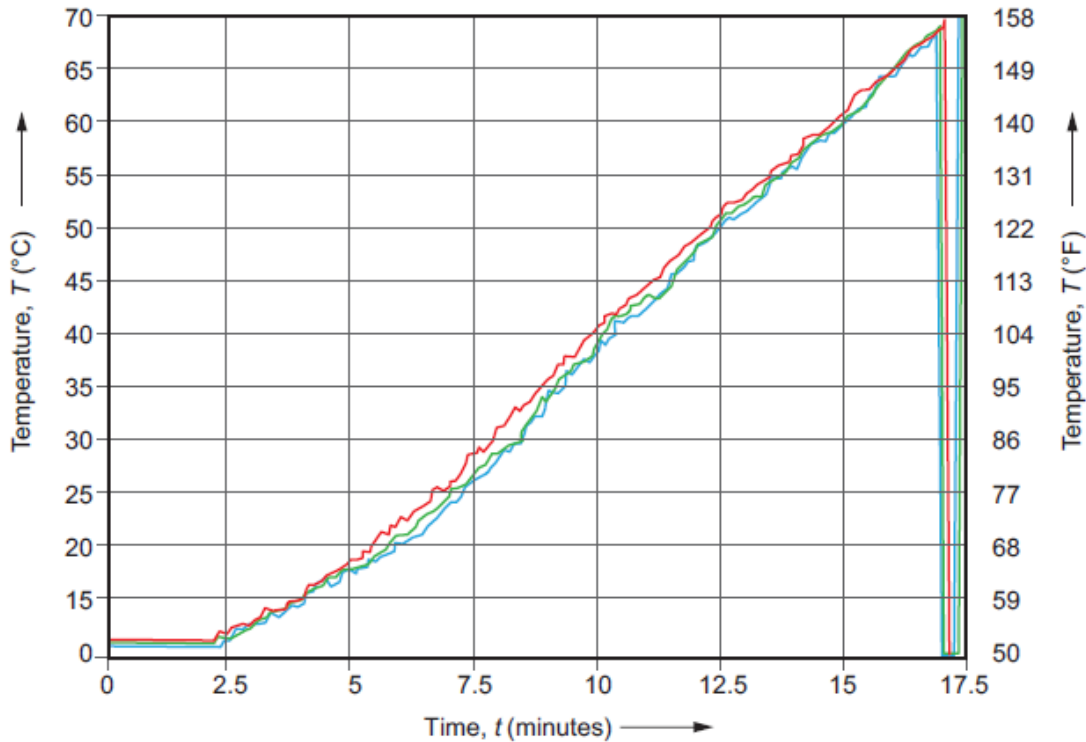

Figure C.17—Liquid Temperature vs Time Profile from the BAM Fire Test ^[112]

The difference between the two methods is not explained by potential liquid swelling because the liquid temperature would have to increase to 86 °C (187 °F) to cause enough wetted area to equal the calculated heat input. This significantly exceeds the maximum temperature reached (see Figure C.17). A likely explanation is that partial confinement due to the adjacent embankment on three sides of the vessel caused higher heat fluxes due to reradiation and preheating of the combustion air. During the development of the API empirical method, L. W. T. Cummings recommended to use a 1.0 exponent on the A_w term for a “vessel located inside a building or enclosure where the absence of air currents permits the flame to surround the vessel to considerable depth” (see Appendix A of Reference [80]). Given the vessel in the BAM test was partially confined on three sides, using a wetted area exponent of 1.0 on half the vessel (rear) and an exponent of 0.82 on the front half results in a heat input of 1349 kW (4.694 MBTU/h), which is 121 % of the heat input calculated by sensible heating of the liquid, which is conservative.

C.6.5.2 Comparison of the Analytical and Empirical Methods Using the BRL Test Data

The BRL fire test discussed in C.6.3 provides data on PRV discharge rates derived (i.e. not directly measured) from liquid level versus time extrapolations to allow a comparison of the API empirical and the analytical methods with the test data to be made. The accuracy of the level change with time is uncertain because the liquid levels had to be derived from wall temperature data because of a failure of the level probe. The API method involved determining the absorbed heat using Equation (8) for inadequate drainage (i.e. fire test set up to have an engulfing pool fire), an environment factor of 1, ellipsoidal heads, and the wetted area based on the level versus time from the BRL test data. The analytical method involved determining the absorbed heat flux using the values of the parameters in Table C.4 for the front and rear walls. A constant surface temperature of 60 °C (150 °F) was used. This temperature corresponds to the average liquid temperature during the period when the PRV was continuously open. The analytical method used the same wetted area as in the API method but with a 1.0 exponent instead of the 0.82 exponent. The relief load for both the API and analytical method was calculated using absorbed heat fluxes and the heat of vaporization for pure propane based on the saturation temperature corresponding to the pressure in the tank car at the specified time from the BRL test data.

The results, given in Figure C.18, show that the BRL relief discharge rates increase with time for most of the test while the opposite occurs for the discharge rates obtained from both the API and analytical methods. Because the wetted area decreases with time as fluid is relieved while the pressure remained relatively constant during the test period, a decrease in discharge rate with time is expected. The anomalous behavior of the BRL data could be due to inaccuracies in the method used to derive level versus time. Another possible explanation could be that the test was conducted within a pit that was 7.92 m (26 ft) in depth compared with a tank car diameter of 3.05 m (10 ft) (i.e. partial confinement). This configuration would be conducive to:

- 1) heating the pit walls to where they would be a thermal radiation contributor to the tank car,
- 2) preheating the combustion air increasing the fire temperature, and
- 3) minimizing wind effects thereby increasing the exposure of the wetted surface areas to fire.

These would increase the heat input into the tank car above that predicted by both the empirical and analytical method. Note that BRL estimated the time-averaged heat input into the wetted area as 104.8 kW/m^2 ($33,230 \text{ Btu/h}\cdot\text{ft}^2$), which compares favorably with the API Equation (8) constant. Combining the BRL relief discharge rates and derived wetted surface areas versus time with API Equation (8) and solving for the exponent on the wetted area gives the curve shown in Figure C.19. This suggests that the test pit configuration may indeed have increased the wetted surface area exposure beyond that assumed by the API empirical method for typical pool fires.

The comparisons suggest that the BRL test configuration provided partial confinement thereby enhancing the fire exposure effects. A conservative approach to account for this when designing a pressure-relief system would be to use the API method [i.e. Equation (8)] with a 1.0 exponent on the wetted area instead of the 0.82 exponent for vessels that are partially confined. In the case of the analytical method, the enhanced fire exposure effects can be taken into account using a more rigorous analytical method whereby the fire temperature, emissivities, etc. are considered variables that change as the fire progresses. Caution should be used when applying either the empirical or the simplified analytical method as defined in A.3.2 when evaluating similar partially confined pool fires.

C.6.6 Use of the Analytical Method to Reproduce Jet Fire Test Data

The use of the analytical method to reproduce jet fire test data is described in Reference [145].

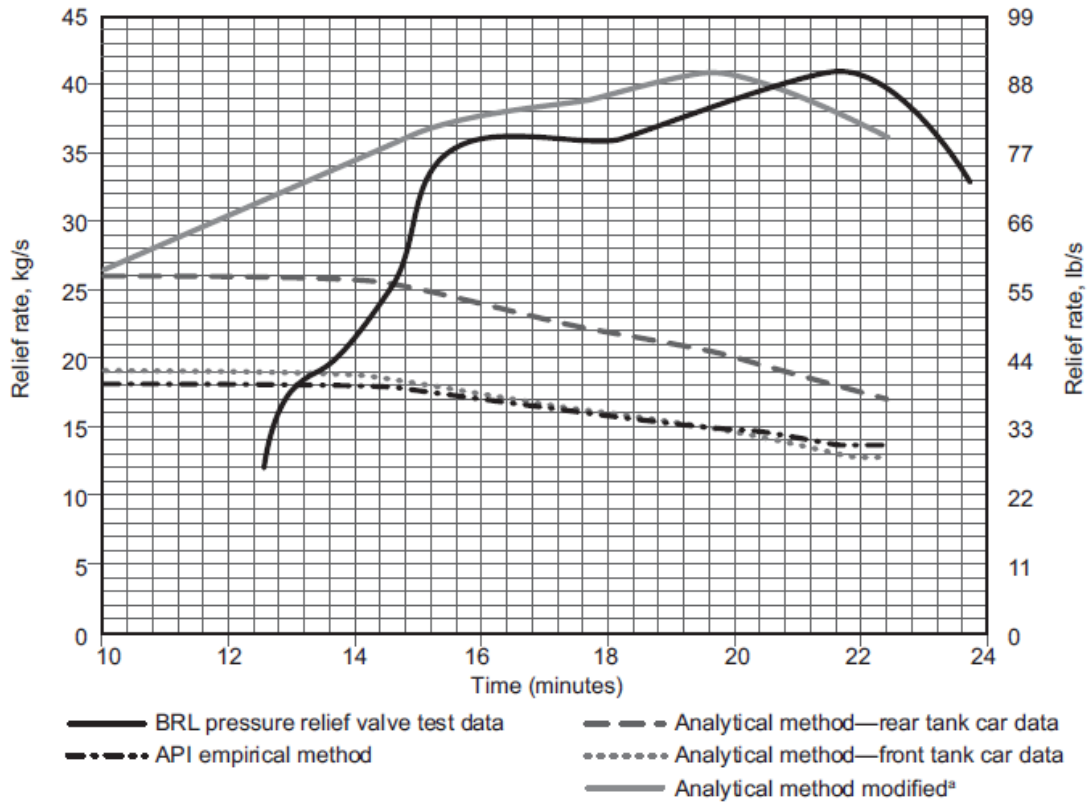

^a The analytical model was modified so the convection heat transfer coefficient, h , and the equipment absorptivity, α_{surface} , increased with time to represent increased heat transfer from the surroundings.

Figure C.18—Comparison of the API Empirical Method and the Analytical Method with BRL Fire Test Data

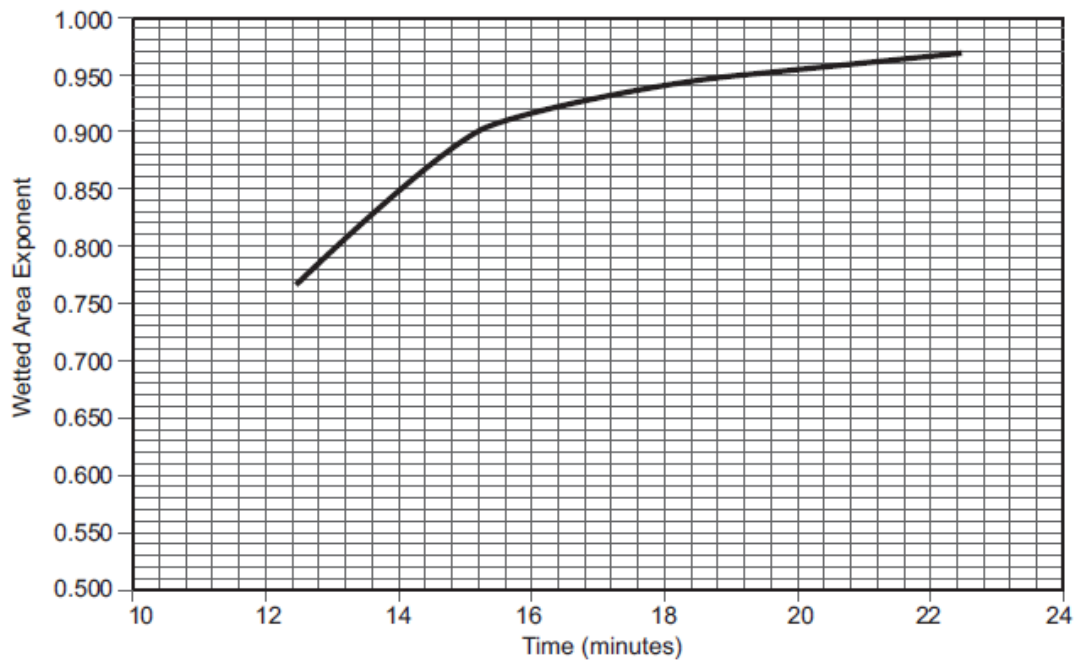

Figure C.19—Calculated Wetted Area Exponent of the API Empirical Method Equation (8) Based on BRL Fire Test Data

C.7 Corrected Hydrotest Pressure Examples

C.7.1 Overpressure Scenario Temperature Equals Design Temperature

Material allowable stress values generally decrease with an increase in temperature (i.e. vessel becomes weaker as the temperature increases). This effect needs to be considered if evaluating the overpressure scenarios defined in 4.2.2. Also, most pressure design codes require this effect to be considered when determining the hydrotest pressure for new vessels. For example, say a vessel has the following design:

- designed in accordance with ASME *BPVC*, Section VIII, Division 1 (2008);
- fabricated from ASTM A515 ^[20] Grade 70 carbon steel;
- design pressure of 75 psig [517 kPa (gauge)];
- MAWP is the same as the design pressure;
- design temperature of 650 °F (343 °C).

ASME *BPVC*, Section VIII, Division 1 (2008) UG-99(b) requires the hydrotest be performed at 130 % of the MAWP. In addition to the 130 %, the hydrotest pressure needs to be corrected for temperature differences between the design temperature and temperature that the hydrotest is conducted (typically ambient temperature). This temperature correction is done by multiplying the MAWP by the ratio of allowable stress at test temperature to the allowable stress at design temperature. ASTM A515 Grade 70 carbon steel has an allowable stress of 18,800 psi (130 MPa) at the stipulated design temperature. Say the hydrotest was conducted at an ambient temperature of 70 °F (21 °C). At this ambient temperature, the allowable stress of ASTM A515 Grade 70 carbon steel is 138 MPa (20,000 psi). The actual hydrotest pressure is then as follows.

In SI units:

$$517 \times (138 / 130) \times 1.3 = 713 \text{ kPa (gauge)} = 138 \% \text{ of the MAWP}$$

In USC units:

$$75 \times (20,000 / 18,800) \times 1.3 = 103.7 \text{ psig} = 138 \% \text{ of the MAWP}$$

When evaluating an overpressure scenario, it is a common and generally conservative practice to use the design temperature to determine the material stress value when the overpressure occurs. For the example above, the corrected hydrotest pressure that should be used for the overpressure scenario evaluations is simply 130 % of the MAWP. In this example, a temperature correction is not required because the MAWP is based on the design temperature. The actual hydrotest pressure should not be used in this example unless a temperature correction is applied because the hydrotest pressure is determined at ambient temperature, not at design temperature. The temperature correction is the ratio of the material stress at the overpressure scenario temperature (i.e. design temperature for this example) to the material stress at the temperature at which the hydrotest was conducted. In other words:

In SI units:

$$\text{Corrected Hydrotest Pressure} = 713 \times (130 / 138) = 672 \text{ kPa (gauge)} = 130 \% \text{ of the MAWP}$$

In USC units:

$$\text{Corrected Hydrotest Pressure} = 103.7 \times (18,800 / 20,000) = 97.5 \text{ psig} = 130 \% \text{ of the MAWP}$$

C.7.2 Correction for Other Temperatures

The preceding example can be generalized using the following expressions, depending upon whether the MAWP or the hydrotest pressure is used as the basis:

$$P_{\text{corrected}} = \text{MAWP} \times H_f \times \frac{\sigma_{\text{scenario}}}{\sigma_{\text{design}}} \quad (\text{C.35})$$

or

$$P_{\text{corrected}} = P_{\text{hydrotest}} \times \frac{\sigma_{\text{scenario}}}{\sigma_{\text{hydrotest}}} \quad (\text{C.36})$$

where

- $P_{\text{corrected}}$ is the corrected hydrotest pressure, expressed in psig (kPa gauge);
- MAWP is the maximum allowable working pressure, expressed in psig (kPa gauge);
- H_f is the pressure design code hydrotest factor (e.g. 1.3 if 130 %);
- σ_{scenario} is the material stress at the overpressure scenario temperature, expressed in psi (MPa);
- σ_{design} is the material stress at the vessel design temperature, expressed in psi (MPa);
- $P_{\text{hydrotest}}$ is the vessel hydrotest pressure, expressed in psig (kPa gauge);
- $\sigma_{\text{hydrotest}}$ is the material stress at the vessel hydrotest temperature, expressed in psi (MPa).

The hydrotest pressure can be corrected for temperatures other than the design temperature using these equations. For example, assume the same vessel design as in C.7.1, that is, ASTM A515 Grade 70 carbon steel with a design pressure (MAWP) of 75 psi (517 kPa) and design temperature of 650 °F (343 °C), but the overpressure scenario temperature is, say, 100 °C (212 °F). The allowable stress is determined to be 20,000 psi (138 MPa) at 212 °F (100 °C). Using the MAWP, the corrected hydrotest pressure to use when evaluating this overpressure scenario is then as follows.

In SI units:

$$P_{\text{corrected}} = 517 \times 1.3 \times (138/130) = 713 \text{ kPa (gauge)}$$

In USC units:

$$P_{\text{corrected}} = 75 \times 1.3 \times (20,000/18,800) = 103.7 \text{ psig}$$

Note that allowable stress values for other materials and other temperatures can be found in ASME *BPVC*, Section II, Part D ^[16], for example.

Annex D (informative)

Typical Details and Sketches

Figure D.1 shows a typical horizontal flare seal drum.

Figure D.2 shows a quench drum.

Figure D.3 shows a typical flare installation.

Figure D.3 represents an operable system arrangement and its components. The arrangement of the system varies with the performance required. Correspondingly, the selection of types and quantities of components, as well as their applications, should match the needs of the particular plant and its specifications.

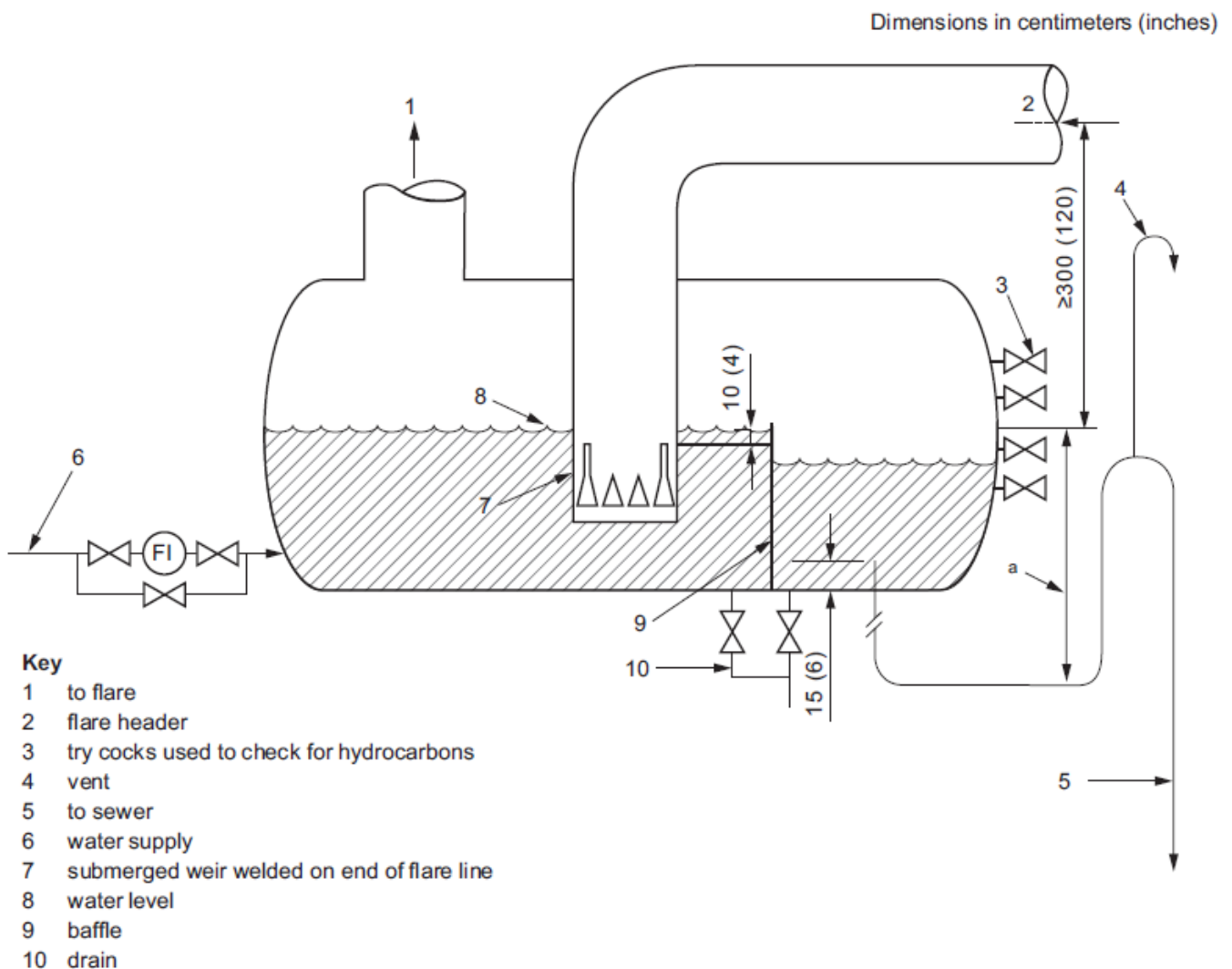

^a The sewer seal should be designed for a minimum of 175 % of the drum's maximum operating pressure.

Figure D.1—Typical Horizontal Flare Seal Drum

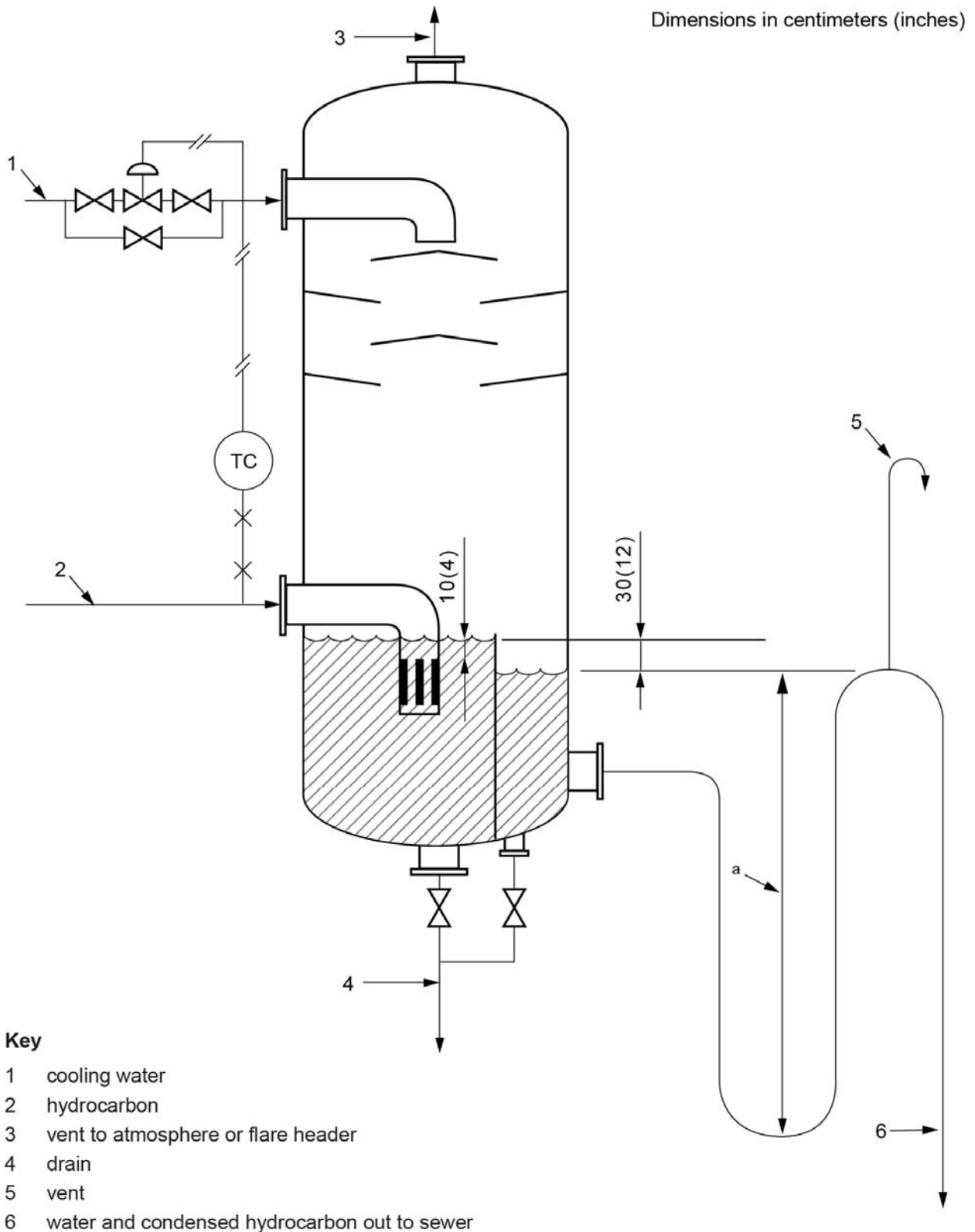

^a The sewer seal should be designed for a minimum of 175 % of the drum's maximum operating pressure; see 5.8.7.3 for details.

Figure D.2—Quench Drum

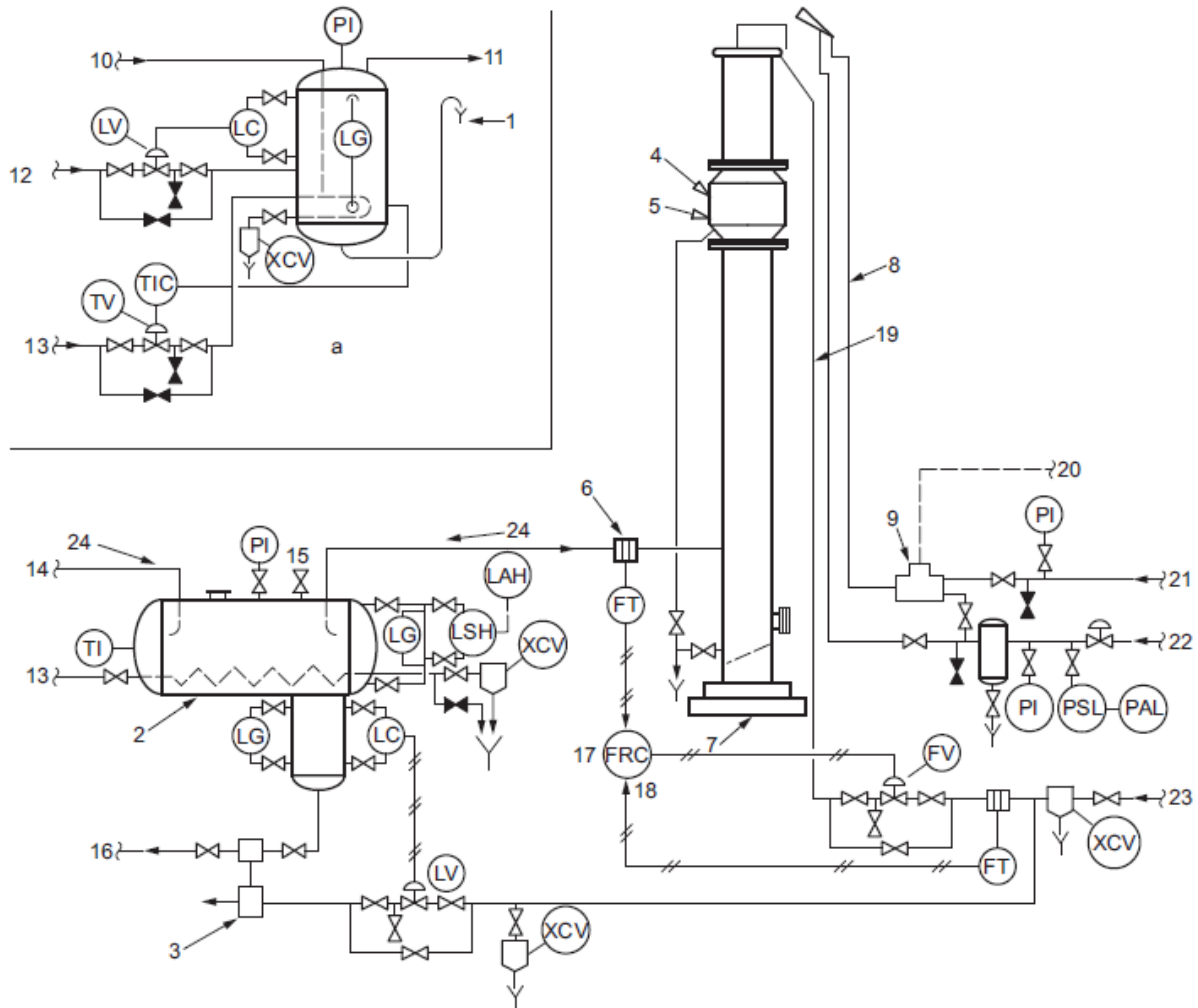

Key

- | | |
|---|---|
| 1 oily water sewer (to sour water system if large quantities of H ₂ S are flared continuously) | 13 steam |
| 2 knockout drum | 14 from relief or vent header system |
| 3 steam-driven pump and electrically-driven spare | 15 vent |
| 4 molecular seal | 16 to oil recovery facilities or slop |
| 5 purge gas | 17 panel-mounted |
| 6 flow-measuring element | 18 ratio |
| 7 flare stack | 19 steam to nozzle manifold for smokeless burning |
| 8 igniter line | 20 power supply for spark ignition |
| 9 flame-front generator | 21 air supply |
| 10 from knockout drum | 22 fuel gas to pilots and ignition |
| 11 to flare stack | 23 steam for smokeless burning |
| 12 water | 24 slope towards drum |

^a Insert shows alternative sealing method (water seal).

Figure D.3—Typical Flare Installation

Annex E (informative)

High-integrity Protection Systems

E.1 Introduction

Traditional methods of pressure relief employ a mechanical device such as a PRD for reducing the likelihood of overpressure of vessels and piping systems. A different approach to overpressure protection is the use of an instrumented system. HIPS typically involve an arrangement of instruments, final control elements (e.g. valves, switches, etc.), and logic solvers configured in a manner designed to avoid overpressure incidents by removing the source of overpressure or by reducing the probability of an overpressure contingency to such a low level that it is no longer considered to be a credible case.

With appropriate levels of redundancy, HIPS can be designed to achieve a level of availability equal to or greater than a mechanical relief device. However, the application of HIPS requires a number of special procedures within the design process to ensure an adequately safe HIPS design, and it requires particular attention during its operational life such as maintenance, testing, and inspection. For these reasons, the decision to implement HIPS on a given project should be made with a great deal of caution and careful consideration. Note that it can be necessary for the required overpressure protection availability to be higher than that provided by a single mechanical relief device.

This annex provides a discussion of the elements of a HIPS, the applicable codes and standards associated with HIPS, and the procedures that should be followed when implementing HIPS.

E.2 Background

E.2.1 Elements of HIPS

A HIPS includes field instruments (e.g. sensors), logic solving devices (e.g. safety system logic solver, relays, etc.), final control elements, power supply and inspection, testing, and maintenance procedures. The boundaries of a HIPS incorporate all aspects from the sensor to the final element.

E.2.2 Application of HIPS

There are five principal uses of a HIPS:

- a) to eliminate a particular overpressure scenario from the design basis;
- b) to eliminate the need for a particular relief device;
- c) to provide system overpressure protection where a relief device is ineffective;
- d) to reduce the probability that several relief devices will have to operate simultaneously, thereby allowing for a reduction in the size of the disposal system;
- e) to reduce the demand rate on a relief device consequently reducing the risk.

There is a large amount of overlap between these categories of HIPS applications; a particular application of HIPS can pertain to more than one of the above categories.

One of the chief benefits of HIPS is cost-effectiveness. By eliminating the need for costly upgrades to an existing relief/flare system or by reducing the size of a new relief/flare system, a large amount of capital savings can be realized. In other cases, by demonstrating the need for smaller or fewer PRDs, less dramatic but still potentially significant cost savings can be realized. Moreover, HIPS can be designed to achieve a higher level of

availability/reliability than a mechanical relief device by using components designed to have very low failure-to-danger rates and that are designed to primarily fail safe by incorporating appropriate levels of redundant instrumentation and by ensuring that the HIPS is inspected and tested on a regular basis. Thus, a HIPS can be used as a risk-reduction measure for particularly high-risk process units (e.g. those that involve acutely toxic materials). In some cases, a HIPS can be used in concert with a relief device (where the relief device is generally a “backup” to the HIPS) to achieve especially high levels of protection. Note, however, that the ongoing cost of ownership of a HIPS should be taken into account. This includes costs of routine testing of the HIPS versus routine PRD maintenance. This ongoing cost rises disproportionately with the SIL level (see 3.1.69, 3.1.70, and E.3.3.2).

HIPS availability addresses only the operation of the HIPS itself. Careful analysis should also be made of the response of the process to the operation of the HIPS. For example, successful operation of a HIPS system to shut off fuel to a fired heater does not eliminate all heat flux to the heater tubes, since there is residual heat contained in the furnace-wall refractory. Further, when a PRD fails such that it opens during normal operating conditions, the effects on the process can vary from an operational nuisance to a major event. When a HIPS operates inadvertently, it can result in a major shutdown and thus incur the hazards associated with the shutdown and subsequent restart.

E.3 Relevant Regulations and Industry Standards

E.3.1 General

The user should obtain the latest edition of the documents referenced in this annex and review local jurisdictional applicability.

E.3.2 ASME BPVC, Section VIII, Division 1 UG-140

In 2008, ASME adopted the opinion that a pressure vessel may be provided with overpressure protection by system design per UG-140 in lieu of or in addition to a mechanical relief device if certain conditions are met. See References [17] and [18] for details.

E.3.3 ISA 84.01

E.3.3.1 General Discussion

ISA 84.01^[91] is intended for those who are involved with electrical/electronic/programmable SIS in the areas of design, manufacturing, selection, application, installation, commissioning, testing, operation, maintenance, and documentation. The main body of the standard presents normative specific requirements.

NOTE ISA 84.01, while recognized by OSHA as good practice, is not in itself mandatory in the United States. The annexes present nonmandatory, but informative, technical information, guidance, and examples that are useful in such applications.

ISA 84.01 defines an SIS as a “system composed of sensors, logic solvers, and final control elements for the purpose of taking the process to a safe state when predetermined conditions are violated. Other terms commonly used include emergency shutdown system (ESD, ESS), safety shutdown system (SSD), and safety interlock system.”

HIPS also fit the definition of an SIS. Accordingly, the philosophy and procedures set forth in ISA 84.01 or other equivalent “good engineering practices” are appropriate for use in the application of HIPS systems for the process industries. ISA 84.01 was released in final form in February 1996. It was adopted as an ANSI standard in March 1997. ISA TR84.02^[92] was issued in 2002 to supplement ISA 84.01; ISA TR84.02 discusses a number of methods for quantifying SIS availability and validating the SIL of proposed designs.

E.3.3.2 Requirements

ISA 84.01 sets forth a performance standard for the design and life-cycle ownership of a SIS, beginning in the research and development stage and continuing all the way through decommissioning. The discussion in E.3.3.2

focuses on those aspects that should be accounted for during the process design stage of an engineering project where the standard is recognized.

The general steps to be followed in using an SIS to protect against a process hazard can be broken down as follows.

- a) Perform a PHA to identify the hazards to be addressed.
- b) Apply non-SIS protection layers first to eliminate identified hazards or reduce the associated risk.
- c) Determine if an SIS is needed.
- d) Define a target SIL or an actual target-availability value for the SIS based on the perceived risk associated with the identified hazards (taking into account non-SIS protection layers).

ISA 84.01 does not specify the method to be used for the PHA, nor does its scope include Items a) through c) above. While a user is free to select from a number of recognized methods, LOPA is effective in assessing the SIL required of a HIPS versus the availability of PRDs. CCPS publishes typical risk-reduction factors for various layers of protection, including PRDs and SISs ^[45].

The SIL (SIL-1, SIL-2, or SIL-3) defines the level of performance (availability required of an SIS expressed in the probability of failure upon demand). The intended level of risk reduction is used to determine the SIL actually required. A higher SIL indicates a more robust system and hence a higher level of availability. The performance requirements for each SIL are given in Table E.1.

Verification that the designed SIS actually meets this performance requirement can be performed quantitatively using one of the methods described in ISA TR84.02 or other recognized technique. This analysis is performed in the design stage by a safety/reliability specialist.

E.3.3.3 Application

The process for applying the SIL requirements of ISA 84.01 to HIPS application consists of the following general steps:

- a) select appropriate SIL or actual availability value;
- b) design SIS to meet target SIL or availability value;
- c) perform availability calculations to verify system integrity;
- d) specify testing intervals and procedures required to maintain the SIL of the HIPS;
- e) apply MOC processes to any modifications.

There is no requirement in ISA 84.01 to perform reliability calculations where spurious trips can be hazardous. It is suggested to consider the probability of a spurious trip and its effect on the system. The operation of HIPS typically results in a major shutdown of a unit, obviously requiring a subsequent start-up. It is recognized within industry that the start-up phase of a unit is the one during which there is a higher possibility of an incident involving loss of containment and or personal injury. In addition, unnecessary shutdowns adversely affect productivity. Thus, it is necessary to ensure that the system configuration reflects a low potential for such spurious trips. Neither the SIL nor the availability values necessarily reflect a high reliability (low frequency of spurious trips). As noted in ISA 84.01, the value and purpose of redundant features, such as 2-out-of-3 voting architecture, in system designs can be more to increase the reliability of the SIS than to increase the availability.

E.3.4 IEC 61508 and IEC 61511

IEC 61508 ^[88] is the international standard that addresses the general requirements for identification and implementation of SISs. IEC 61508 is a broad-scope document intended to cover a wide range of industries.

IEC 61511 (all parts) ^[89] was issued in 2003. These documents address IEC 61508 requirements as applicable to the process industries and, with some differences, are equivalent to ISA 84.01. It is likely that once IEC 61511 is adopted, ISA will adopt this standard as a replacement to ISA 84.01. The user is cautioned to verify which standard is in effect at the time of the design of HIPS. The chief differences between IEC and ISA standards are summarized as follows:

- a) IEC 61508 includes a provision for a fourth SIL, SIL-4, which requires a system's minimum availability of 99.99 %;
- b) IEC 61508 discusses and specifies requirements related to external (noninstrumented) risk-reduction facilities;
- c) IEC 61508 requires the use of the ISO 9000 series of quality systems or equivalent, whereas ISA 84.01 does not;
- d) IEC 61508 requires the use of a "safety plan," whereas ISA 84.01 requires documentation consistent with 29 CFR 1910.119 ^[133];
- e) IEC 61508 addresses a number of management system issues that are outside the scope of ISA 84.01; for U.S. applications, these management-system issues are covered extensively by 29 CFR 1910.119;
- f) IEC 61508 uses a number of terms and abbreviations that are slightly different from those found in ISA 84.01;
- g) IEC 61508 has additional hardware and software requirements that becomes more demanding with increasing SIL requirement.

The user should ensure that component failure rates applied in availability calculations accurately reflect the type and model of the component installed in the HIPS and the intended service. The component failure rates are key to calculating HIPS availability and setting the required testing intervals. While using one's own company's and service-specific data is preferable, there are a number of publicly available sources listing component failure rates. The selected data should best approximate the industry, equipment, and service planned for or installed in the HIPS and should be based on sufficient populations of unrevealed failure events to be statistically significant.

E.3.5 Comparison of Various SIL Standards

Table E.1 compares the various SIL standards.

E.4 Procedures for Applying HIPS

E.4.1 General

The use of HIPS for any particular application has both advantages and disadvantages. Thus, for a given case, it is necessary to weigh the risk versus the benefit and make a well-considered, informed decision as to whether HIPS is the best option.

Table E.1—Safety Integrity Level vs Availability

SIL			SIS Performance Requirements	
ISA 84.01	IEC 61508	DIN V 19250 ^[52] (TUV Class)	Safety Availability Required %	Average Probability of Failure on Demand PFD_{avg}
1	1	1 and 2	90.00 to 99.00	10^{-1} to 10^{-2}
2	2	3 and 4	99.00 to 99.90	10^{-2} to 10^{-3}
3	3	5 and 6	99.90 to 99.99	10^{-3} to 10^{-4}
	4	7	>99.99	$<10^{-4}$
—	—	8	>99.999	$<10^{-5}$

E.4.2 Safety Integrity Level Assignment or Availability Value

In accordance with ISA 84.01, a necessary step in SIS design is to set a SIL or availability value target for system design. The system is assigned as a SIL-1, SIL-2, or SIL-3 system, with SIL-3 being the most robust and most reliable and SIL-1 being the least. Associated with each SIL is a minimum performance requirement, that is, a minimum of 90 % availability for SIL-1, a minimum of 99 % availability for SIL-2, and a minimum of 99.9 % availability for a SIL-3 system. The determination of target SIL for a given system is dependent upon the risk associated with the hazard that the system is protecting against, that is, the likelihood of the initiating and contributing events, the magnitude of the consequences, and the credit that can be taken for other safeguards. The SIL assignment should be performed by a multidisciplinary team.

The acceptability criterion for HIPS performance is expressed in terms of the SIL level, which corresponds to a level of system availability (i.e. the probability that the system will work properly when needed). Each case should be examined individually to determine the appropriate response. The selected SIL for a given system is dependent upon a number of factors, including the following:

- a) likelihood of placing a demand on the HIPS in the first place (i.e. the likelihood of getting a high-high pressure situation that requires proper action from the HIPS in order to prevent a negative consequence);
- b) consequences of a failure of the HIPS, given that a demand has been placed on it;
- c) risk tolerance of the user;
- d) requirements from local jurisdictional authorities.

In the large majority of cases for HIPS, the result of the hazard analysis is either a SIL-2 system (requiring a minimum of 99 % availability) or a SIL-3 system (requiring a minimum of 99.9 % availability).

E.4.3 Conceptual Proposal of HIPS Configuration

After a target SIL or availability value has been assigned, a base case HIPS configuration should be devised, with the intention of arriving at a system configuration that meets the availability requirement associated with the assigned SIL. At this point, a base case maintenance/testing interval for the individual components of the HIPS should be decided as well. The base case configuration and test data then serve as the basis for the next step in the work process, the reliability analysis.

E.4.4 HIPS Availability Analysis

The purpose of the HIPS availability analysis is to evaluate the system performance of the proposed configuration. The availability analysis should utilize standard techniques, such as fault tree analysis (see ISA TR84.02). In addition to considering the integrity of the hardware, which is addressed in part by suitable scope and frequency of testing, the potential for human error and other sources of systematic failures throughout the system lifecycle should also be considered. The result produced is compared against the performance requirement associated with the assigned SIL to determine if the proposed system is acceptable. If the proposed system does not meet the performance requirement, then it is necessary to modify the system configuration by the following:

- a) using better quality sensors, logic solvers, and final control elements with lower unrevealed failure rates;
- b) increasing the level of diagnostic coverage so that fewer of the failure modes are unrevealed and become revealed through the action of the diagnostics facility;
- c) using redundant components (i.e. duplicated or even triplicated elements);
- d) using diverse components;
- e) increasing the planned testing frequency.

Careful consideration should also be given in the system design to the calculated rate of nuisance failures. Nuisance trips can be costly and also increase the risk that operators might circumvent the shutdown systems. The potential for nuisance failures can be reduced by including functions such as voting logic and similar techniques to make the application more robust to spurious failures. These provisions can decrease the required testing interval.

E.5 Test Intervals for HIPS

For a typical SIS, the large majority of instrument failures that it is necessary to consider are the type of failure that is referred to as a dormant fault (or covert or unrevealed failure). A dormant fault occurs when an equipment item that is not under constant demand fails, such that the failure is not immediately detected. Such a failure is detected only when either the item fails on demand during a test or the item fails on an actual demand. Accordingly, the frequency of testing plays an important role in determining the availability of an item to perform its intended function on demand.

Take, for example, the case of a high-pressure switch. The switch can be expected to enter a failed state at a constant rate in units of 1/time. However, since the switch is only required to perform its function in the event of high pressure, this failure is not revealed until there is a demand placed on it, either through a test or a true process demand. It is assumed that if the switch fails on demand, it will be immediately repaired or replaced. Thus, the unavailability of the pressure switch, or the probability that it will fail on demand, is a direct function of the test interval.

NOTE This example is illustrative. In a SIL-2 or SIL-3 application, process-connected switches are seldom sufficiently available to support the required integrity. Process transmitters are generally used because of their lower unrevealed failure rates.

Because of this, it is critical that the instrumentation associated with a HIPS be tested at regular intervals. The availability analysis assumes a test interval for each piece of equipment. In order for the actual HIPS reliability to align with that predicted by the availability calculations, it is necessary that the actual testing frequency (during operation) corresponds with that assumed in the availability calculations performed during the design.

There are two other important aspects of testing that should be considered in setting testing intervals. The first is the capability of the site at which the HIPS is to be installed to carry out such tests. There is little value in specifying a system that requires testing a HIPS every 3 months where the site only has the resources for annual testing. Secondly, testing as a process contains the potential for introducing faults and spurious shutdowns due to human error. The consequences of such events can be hazardous and every effort should be made to minimize their occurrence. Thus, where possible, the aim should be to design a system that can achieve the desired availability with the minimum of off-line testing. The advent of supervised circuits, built-in diagnostics, and the use of built-in redundancy (that facilitates on-line testing of components and circuits) all contribute to minimizing the frequency of off-line testing.

E.6 Documentation

As indicated in ISA 84.01, documentation of HIPS should be consistent with 29 *CFR* 1910.119. All of the design criteria, calculations, installation details, and follow-on maintenance and testing should be properly documented.

E.7 Training

Adequate training should be provided to operating and maintenance personnel to ensure that the integrity of the HIPS system is maintained as designed.

E.8 Additional Source Material

Additional source material can be found in References [4], [40], [44], [45], [89], [99], [120], and [121].

Annex F (informative)

Flare Background Information

F.1 Flame Properties

F.1.1 Type of Flame

A flame is a rapid, self-sustaining chemical reaction that occurs in a distinct reaction zone. The two basic types of flames are:

- a) the diffusion flame (nonpremixed flame where only fuel exits from the nozzle), which is found in conventional flares and occurs on ignition of a fuel jet issuing into air, and
- b) the aerated flame, which occurs when fuel and air are premixed before ignition.

F.1.2 Combustibility

Combustibility is a complex subject involving chemical reactions, fluid flow, ambient conditions, and mechanical arrangement of the flare burner^[131]. When an operating flare is in service, flow rates, compositions, wind, and weather are largely uncontrolled. There is no single method to predict combustibility of a gas stream. The combustion characteristics depend upon the type of flare burner being used, smoke suppression fluid (e.g. steam, air, water, nitrogen) when used, and combustion zone flammability and reaction kinetics. Consult the flare manufacturer for additional information.

F.1.3 Gas Velocity at Flare Tip

In the case of an elevated flare, the flame front is normally at the top of the stack; however, at low gas velocities, back mixing of air occurs in the top of the stack. Experiments^[87] have shown that if a sufficient flow of combustible gas is maintained to produce a flame visible from ground level, there is usually no significant back mixing of air into the stack. At lower gas flows, there is the possibility of combustion at a flame front located part of the way down the flare tip with a resultant high tip temperature. Or there can be flame extinguishment with subsequent formation of an explosive mixture in the stack and ignition from the pilot light and a flashback.

In an aerated flame from a premixing device, such as a flare pilot, a phenomenon known as flashback can occur. This results from the local flow velocity of the combustible mixture becoming less than the flame velocity, causing the flame to travel back to the location where the mixture starts becoming flammable.

In the case of diffusion flames, if the fuel flow rate is increased until the local flow velocity exceeds the flame velocity at every point, the resultant turbulent mixing and dilution with air can cause the flame to be lifted above the burner until a new stable position in the gas stream above the burner is reached. This phenomenon is called a detached stable flame. At even higher velocities, the flame becomes unstable eventually leading to a flame-out. A detached flame, whether stable or unstable, is termed lift-off. Both lift-off and flashback velocities are greater for fuels that have high burning velocities. Small amounts of hydrogen in a hydrocarbon fuel widen the stability range because lift-off velocity increases much faster than flashback velocity.

The allowable flare burner exit velocity is a function of relief gas composition, flare burner design, and the gas pressure available. These parameters are interrelated. Some flare tips incorporate a flame-retention device or other means that provides a stable burning flame either attached or detached relative to the flare tip. There is evidence^[59, 76, 98, 150, 152, 153, 160] that flame stability can be maintained at relatively high velocities depending on the discharge properties and the type of tip used. Experience has shown that a properly designed and applied flare burner can have an exit velocity of more than Mach 0.5, if pressure drop, noise, and other factors permit. Many pipe flares, assisted or unassisted, and air-assisted flares have been in service for many years with maximum Mach numbers of Mach 0.8 and higher.

Some flares are subject to regulations that limit exit velocity. For example, pipe flares applied in the United States as control technology for volatile organic compound (VOC) emissions can have gas exit velocity limited by 40 *CFR* 60.18 [58]. In some locales, the 40 *CFR* 60.18 requirements on exit velocities have been extended to “emergency conditions.” The regulations provide guidelines for the determination of the maximum exit velocity as a function of waste-gas characteristics and the type of flare burner employed. It is important to note that there are many flare applications that do not involve VOC control. Such flares are not usually required to meet the exit velocity requirements of the *CFR*.

F.2 Calculation of Radiation

A common approach to determining the flame radiation to a point of interest is to consider the flame to have a single radiant epicenter and to use the following empirical equation by Hajek and Ludwig [76]. Equation (F.1) may be used for both subsonic and sonic flares, provided the correct *F*-factor is used.

$$D = \sqrt{\frac{\tau \times F \times Q}{4\pi \times K}} \quad (\text{F.1})$$

where

D is the minimum distance from the epicenter of the flame to the object being considered, expressed in m (ft);

τ is the fraction of the radiated heat transmitted through the atmosphere;

NOTE See C.2.3.6.3 for further information on the use of τ .

F is the fraction of heat radiated;

Q is the heat release based on the lower heating value, expressed in kW (Btu/h);

K is the radiant heat intensity, expressed in kW/m² (Btu/h·ft²).

A discussion of the single-epicenter equation, Equation (F.1), and its terms together with a review and comparison of a number of interpretations of the method can be found in Reference [150].

The *F*-factor allows for the fact that not all the heat released in a flame can be transferred by radiation, and several factors affect the fraction radiated, including the following [153]:

- a) gas composition;
- b) flame type;
- c) state of fuel/air mixing;
- d) soot and smoke formation;
- e) quantity being burned (turndown);
- f) liquid in the flare gas;
- g) flame temperature;
- h) flare burner design;
- i) combustion equipment condition;
- j) smoke suppression fluid quantity, properties and location of injection point(s) into the flare gases;
- k) flammability limits.

Measurements of radiation from flames indicate that the fraction of heat radiated (radiant energy per total heat of combustion) increases toward a limit, similar to the increase in the burning rate with increasing flame diameter. The F -factor is a correlating parameter between specific calculation methodologies [e.g. C.2, Example 1 (simple sizing approach) and Example 2 (Brzustowski and Sommer)] and empirical data. It may not be used interchangeably between different methods. In other words, the F -factor from one method should not be combined with the flame length calculated from another method.

The F -factor data from the United States Bureau of Mines ^[168] for radiation from gaseous-supported diffusion flames are given in Table F.1. These data apply only to the radiation from a flame from subsonic flares. If liquid droplets of hydrocarbon larger than 150 μm in size are present in the flame, the values in Table F.1 should be somewhat increased. If the flame is not entirely smokeless, the effective overall F -factor can be less than the values in Table F.1. Exit velocity and flare tip design can also influence the F -factor.

Table F.1—Radiation from Gaseous Diffusion Flames

Gas	Burner Diameter cm	Fraction of Heat Radiated
Hydrogen	0.51	0.095
	0.91	0.091
	1.90	0.097
	4.10	0.111
	8.40	0.156
	20.30	0.154
	40.60	0.169
Butane	0.51	0.215
	0.91	0.253
	1.90	0.286
	4.10	0.285
	8.40	0.291
	20.30	0.280
	40.60	0.299
Methane	0.51	0.103
	0.91	0.116
	1.90	0.160
	4.10	0.161
	8.40	0.147
Natural gas (95 % CH ₄)	20.30	0.192
	40.60	0.232

Two methods are presented in C.2 for considering radiation levels. The example in C.2.2 is the simple approach that has been used for many years. It uses Figure F.1 and Figure F.2 to determine an estimated flame length. The wind tilts the flame in the direction the wind is blowing. The wind effect is obtained from Figure F.3, which relates horizontal and vertical displacement of the flame to the ratio of lateral wind velocity to stack velocity. A wind velocity of 9 m/s (20 mph) at the elevation of the flare tip, blowing towards the receiver, is a typical assumption for flame tilt assessment. Different wind speeds might be more appropriate for some locations. The flame radiation epicenter is located at the center of a straight line drawn between the flare tip and the end of the flame. Figure F.1 through Figure F.3 should be used only for subsonic flares and the flare manufacturer should be consulted for sonic flares.

The methods presented here assume that a flame can be modeled by a single point source for radiation. The radiation flux that is modeled should comply with this assumption when determining spacing and radiation exposure. If the point of interest is too close to the flame for the single point assumption, more complex radiation analysis should be employed. Further, radiation analysis is required where there are multiple operating flares in proximity to each other.

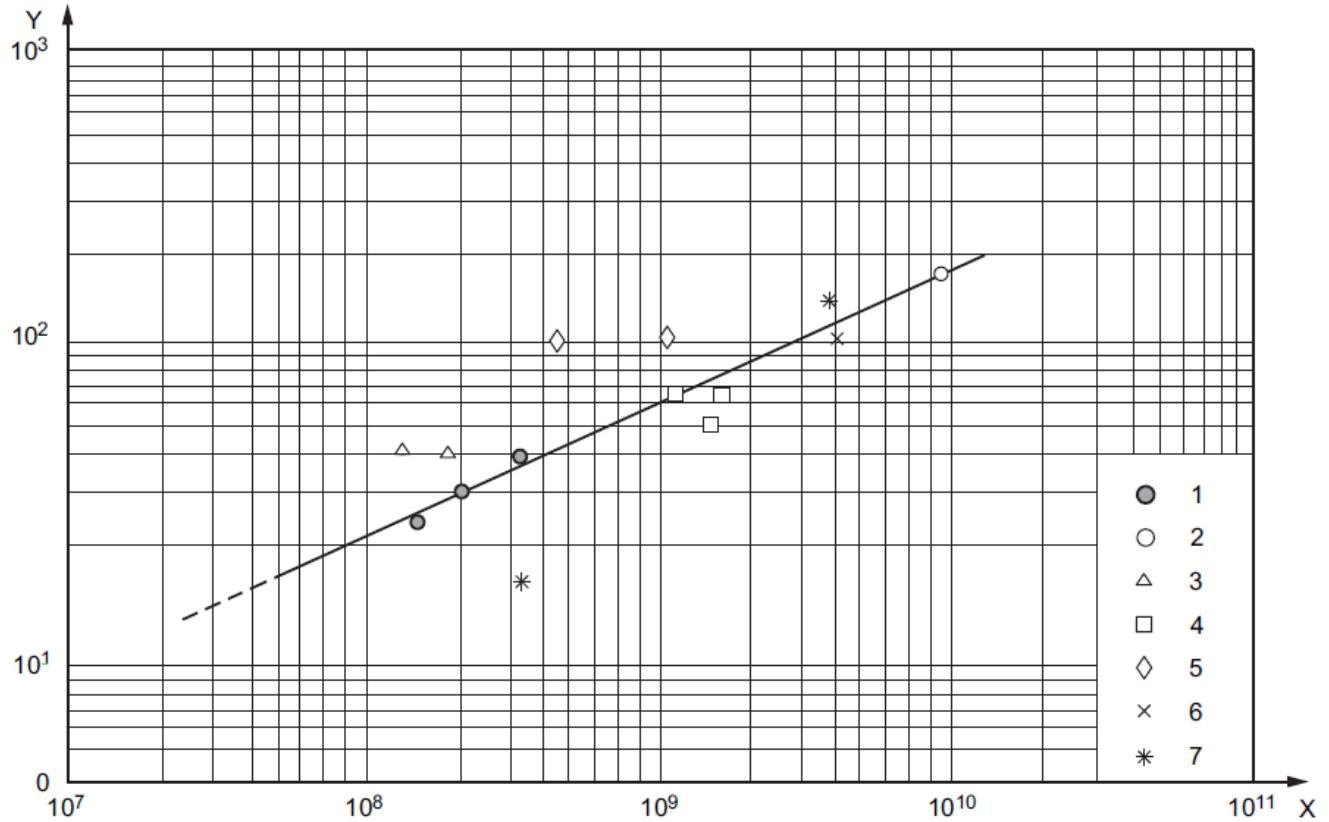

Key

- X heat release, expressed in watts
- Y flame length (including any lift-off), expressed in meters
- 1 fuel gas (508 mm stack)
- 2 Algerian gas well
- 3 catalytic reformer—recycle gas (610 mm stack)
- 4 catalytic reformer—reactor effluent gas (610 mm stack)
- 5 dehydrogenation unit (305 mm stack)
- 6 hydrogen (787 mm stack)
- 7 hydrogen (762 mm stack)

NOTE 1 This figure was converted from Figure 6.

NOTE 2 Multiple points indicate separate observations or different assumptions of heat content.

Figure F.1—Flame Length vs Heat Release—Industrial Sizes and Releases (SI Units)

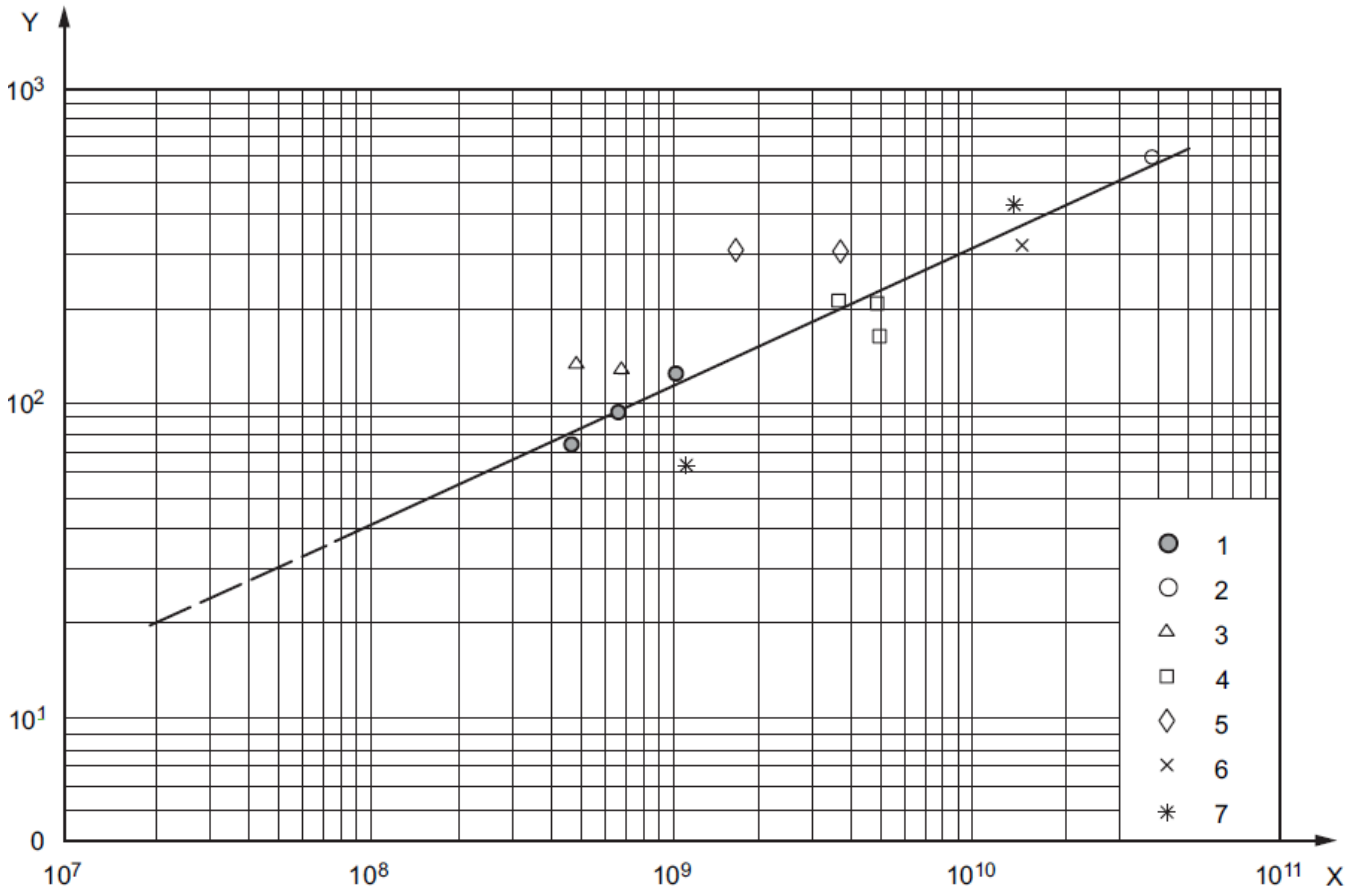

Key

- X heat release, expressed in Btu/h
- Y flame length (including any lift-off), expressed in feet
- 1 fuel gas (20 in. stack)
- 2 Algerian gas well
- 3 catalytic reformer—recycle gas (24 in. stack)
- 4 catalytic reformer—reactor effluent gas (24 in. stack)
- 5 dehydrogenation unit (12 in. stack)
- 6 hydrogen (31 in. stack)
- 7 hydrogen (30 in. stack)

NOTE Multiple points indicate separate observations or different assumptions of heat content.

Figure F.2—Flame Length vs Heat Release—Industrial Sizes and Releases (USC Units)

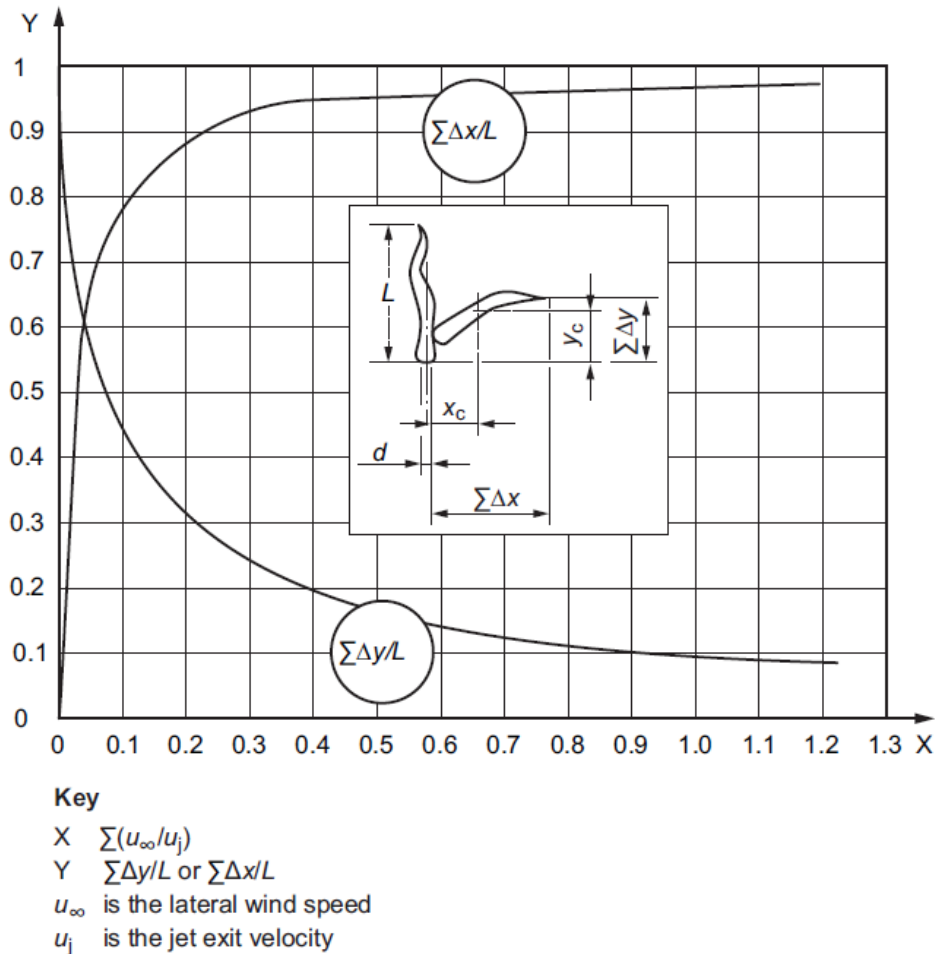

Figure F.3—Approximate Flame Distortion Due to Lateral Wind on Jet Velocity from Flare Stack

The location of the flame center is quite significant when radiation levels are examined. Flame length varies with emission velocity and heat release. Information on this subject is limited and is usually based on visual observations in connection with emergency discharges to flares. Figure F.1 and Figure F.2 were developed from some plant-scale experimental work on flame lengths covering relatively high release rates of various mixtures of hydrogen and hydrocarbons.

Several equations for calculating flame length and approximating flame tilt are presented in the literature [36, 47, 82, 139,151]. Each equation has its own special range of applicability and should be used with caution, particularly since the combined impact of several factors (radiation, radiant heat fraction, flame length and center, and flame tilt) shall be considered.

The example in C.2.3 is another approach to calculating the probable radiation effects, using the more recent method of Brzustowski and Sommer [36]. The principal difference between these methods is the location of the flame center. The curves and graphs necessary to simplify the calculations are included in C.2.

There are other methods that can be utilized to calculate radiation from flares. More sophisticated models that consider wind velocity, exit flare gas velocity, flame shape, and flame segmental analysis can be appropriate for special cases, especially with large release systems.

Most flare manufacturers have developed proprietary radiation programs based on empirical values. The F -factor (fraction of heat radiated) values used in these programs are specific to the equations used, and might not be interchangeable with the F -factor values used in Equation (F.1). These programs have not been subject to review and verification in the open literature. The user is cautioned to assess the applicability of these methods to their particular situation.

Annex G (informative)

Vapor Breakthrough into Liquid-containing Systems

Failure of high-pressure vessel liquid bottoms level control and/or bypass valves discharging into a low-pressure system may result in a significant increase in the low-pressure system liquid level. Depending on the high-pressure and low-pressure system volumes, liquid inventories and liquid properties, the low-pressure downstream system may overflow with liquid.

Of special concern, in certain cases this scenario may be followed by loss of liquid level in the high-pressure system that can result in vapor breakthrough across the level control and/or bypass valves to the low-pressure systems (the scenario described in 4.4.8.3). As the vapor passes through the level control valve, the vapor will expand and push (displace) the liquid in the downstream system until a relief path is established. This transient scenario is commonly described as liquid displacement. During the scenario, the liquid level in the low-pressure vessel can rise creating the potential for liquid or two-phase relief. This can result in increased low-pressure system relief requirements relative to a vapor breakthrough with only vapor relief. The consequences of liquid displacement are sensitive to the size of the low-pressure system and liquid inventories in the high and low-pressure systems prior to the start of the scenario. Hence, a review should be undertaken to identify the worst-case conditions (e.g. combined liquid inventories and system pressures) for the liquid displacement assessment considering all equipment operations/status.

In this annex, general considerations are described to identify potential liquid displacement relief requirements associated with the vapor breakthrough scenarios. Other publications provide more information on liquid displacement analysis ^[63, 119].

The phase quality and flowrate of the relieved stream depends on following factors:

- 1) high- and low-pressure systems operating temperature and pressure;
- 2) high- and low-pressure systems fluid composition;
- 3) high- and low-pressure systems liquid levels; i.e. liquid inventories; prior to failure of the inlet valve(s)
- 4) liquid-vapor onset/disengagement regime: foamy, bubbly, and churn-turbulent fluids;
- 5) vapor superficial velocity in low-pressure vessel;
- 6) low-pressure vessel orientation (vertical or horizontal);
- 7) low-pressure vessel inlet nozzle elevation;
- 8) low-pressure vessel inlet flow distributor geometry and orientation (if present);
- 9) location of the pressure relief device; and
- 10) assumption for continuation of high-pressure and low-pressure systems liquid outflows at normal minimum rates.

Depending on the high- and low-pressure systems liquid inventories, there are two potential relief scenarios that may be relevant.

- 1) Upstream system liquid inventory is less than the downstream system vapor volume at relief conditions.

The user should determine the liquid level in the low-pressure vessel assuming all liquid from the high-pressure vessel and the piping between the two vessels has transferred. A vapor-liquid disengagement analysis should

then be performed to determine the phase of the relief stream. The DIERS Project Manual ^[69] and the CCPS *Guidelines for Pressure Relief and Effluent Handling Systems* ^[43] provide guidance to determine if two-phase relief will occur due to liquid swell (e.g. the increase in liquid level due to liquid and vapor mixing) or liquid entrainment caused by the velocity of the vapor across the surface of the liquid.

Complete vapor-liquid disengagement with no liquid entrainment will result in vapor relief. The required vapor relief rate should be determined using the guidance provided in 4.4.8.3. In case it is assumed that liquid will continue to flow from the high-pressure system, then the impact of flashing liquid on relief requirements should be evaluated.

However, if the vapor-liquid disengagement analysis reveals a two-phase flow, then the guidance provided in the DIERS Project Manual ^[69] and the CCPS *Guidelines for Pressure Relief and Effluent Handling Systems* ^[43] can be used to estimate the two-phase relief stream quality. This guidance considers the fluid regime, i.e. foamy, bubbly, or churn-turbulent. The required relief rate should be equal to the volumetric flow of fluid entering the system through the flow limiting element (wide-open control valve, bypass valve, restriction orifice) displacing an equal volume of the two-phase mixture at relief conditions, taking into consideration the mixing with swelled liquid phase.

If the low-pressure vessel's inlet nozzle becomes submerged, then when the vapor breakthrough occurs the vapor will be sparged into the low-pressure vessel causing the liquid level to rise further. In this scenario, the user should evaluate if a two-phase relief could occur due to inadequate vapor-liquid disengagement or due to liquid re-entrainment caused by high velocity vapor flow.

- 2) Upstream system liquid inventory is more than the downstream system vapor volume at relief conditions.

In this case, the low-pressure vessel overfills before the vapor breakthrough occurs. The initial relief will be a steady-state liquid relief (or steady-state two-phase relief). However, it is expected that the liquid level in the high-pressure vessel will eventually be lost, which would result in vapor breakthrough. Since the low-pressure system is liquid full, the required relief rate should be calculated based on the displaced liquid at a rate equal to the volumetric flow of vapor or two-phase fluid entering the system through the flow limiting element (wide-open control valve, bypass valve, restriction orifice) at relief conditions. Liquid displacement should be calculated using liquid and vapor densities at the relieving conditions.

Consideration should be given to alternate modes of operation where liquid may not be present in the upstream vessel (start-up/shutdown/catalyst treatment) and taking credit for liquid passing through the control valve would not be appropriate. Additionally, in some cases multiple MAWP's may exist under different operating temperatures. One example of this is minimum pressurization temperature where the temperature of the equipment is raised gradually to increase metal ductility before increasing pressure. Another is where an alternate high-temperature operation is conducted during catalyst conditioning. In both cases, this results in a lower temporary MAWP than normal.

The user may consider taking credit for two-phase flow across the control valve if there is continuous liquid flow into the high-pressure system to reduce the vapor breakthrough rate during the relief event and hence reduce the liquid displacement relief rate. In these cases, the vapor phase density in the low-pressure system should account for liquid flashing at relieving conditions.

It should be noted that the relief rate calculated for liquid displacement often results in substantial relief requirements. The following options may be considered to mitigate the overpressure scenario or reduce the relief requirements of liquid displacement.

- 1) Designing an inherently safer system by increasing the low-pressure system MAWP to eliminate the applicability of the overpressure scenario. However, the impact on the equipment downstream of the low-pressure system should be evaluated.
- 2) Increasing the size and vessel capacity of the low-pressure system to allow vapor-liquid disengagement to occur and to prevent overfilling the low-pressure system.
- 3) Sizing the pressure relief devices for liquid displacement.

- 4) Providing HIPS on the high-pressure system that isolates the flow to the low-pressure system on low liquid level in the high-pressure system and/or high level in the low-pressure system.
- 5) Providing HIPS on the low-pressure system to progressively remove the liquid from the low-pressure system.
- 6) Restricting inlet flow through the flow limiting element.
- 7) Taking credit for reduction in relieving flow due to flow resistance of the piping between high-pressure and low-pressure systems.
- 8) Modifying the liquid levels to provide additional vapor space to accommodate the maximum anticipated liquid inventory.
- 9) Considering downstream overflow protection per guidance in 4.4.7.
- 10) Determining if credit can be taken for the downstream system out flow paths.
- 11) Performing detailed dynamic simulation of inlet control valve failure and potential liquid displacement per guidance in 4.3.3.

If the selected option to mitigate the overpressure scenario or reduce the relief requirements of liquid displacement results in liquid release to the disposal system, then the impact on PRD size, slug flow in disposal system piping, and knockout drum capacity should be evaluated.

Annex H (informative)

Flow-induced Vibration

Pressure-relieving systems are usually designed with relatively high fluid velocities. The resultant turbulence energies increase after tees, reducers, bends, valves, etc. due to vortex formations with pressure fluctuations. These pressure fluctuations increase with higher fluid velocities, and their frequency spectra have broadband characteristics with peaks in the lower frequency region. These pressure fluctuations may induce piping vibrations at relatively low frequencies if the piping system has insufficient stiffness. This phenomenon is called flow-induced vibration. This vibration may result in fatigue failure of the piping system. The turbulence energy becomes enlarged particularly just after the expansion at laterals or reducers (enlargements) ^[55].

NOTE Piping codes (e.g. ASME B31.3 ^[18]) require that piping be designed, arranged, and supported to mitigate the effects of vibration from sources.

A screening method of flow-induced vibration is included in an Energy Institute document ^[55]. Experimental studies on flow-induced vibration for tee junctions are available in References [115], [129], and [130].

Common examples of the mitigation options to prevent piping fatigue failure due to flow-induced vibration include, but are not limited to, the following ^[55, 129, 130]:

- a) reducing the velocity by enlarging the pipe diameter;
- b) adding piping supports;
- c) increasing wall thickness.

Bibliography

- [1] ABMA-BOILER 402, *Boiler Water Quality Requirements and Associated Steam Quality for ICI Boilers*
- [2] AGA XK0101 ¹, *Purging Principles and Practice*
- [3] AIHA ², *Emergency Response Planning Guidelines*
- [4] API Standard 170, *Standard for Subsea High Integrity Pressure Protection Systems (HIPPS)*
- [5] API Recommended Practice 520, *Recommended Practice for the Design and Construction of Pressure Relieving Systems for Process Equipment and Pressure Storage in Refineries* (tentative), First Edition
- [6] API Standard 526, *Flanged Steel Pressure-relief Valves*
- [7] API Standard 618, *Reciprocating Compressors for Petroleum, Chemical, and Gas Industry Services*
- [8] API Recommended Practice 752, *Management of Hazards Associated with Location of Process Plant Permanent Buildings*, Third Edition, 2009
- [9] API Recommended Practice 920, *Prevention of Brittle Fracture of Pressure Vessels*, 1990
- [10] API Publication 999 (English Edition), *Technical Data Book—Petroleum Refining*
- [11] API Standard 2000, *Venting Atmospheric and Low-pressure Storage Tanks*
- [12] API Recommended Practice 2003, *Protection Against Ignitions Arising Out of Static, Lightning, and Stray Currents*
- [13] API Recommended Practice 2030, *Application of Fixed Water Spray Systems for Fire Protection in the Petroleum and Petrochemical Industries*
- [14] API Recommended Practice 2216, *Ignition Risk of Hydrocarbon Liquids and Vapors by Hot Surfaces in the Open Air*
- [15] API Standard 2510, *Design and Construction of LPG Installations*
- [16] ASME *Boiler and Pressure Vessel Code (BPVC)* ³, *Section II: Materials; Part D: Properties*
- [17] ASME *BPVC, Section VIII: Rules for Construction of Pressure Vessels*
- [18] ASME B31 *Code for Pressure Piping*, B31.3, *Process Piping*
- [19] ASME B31 *Code for Pressure Piping*, B31.8, *Gas Transmission and Distribution Piping Systems*
- [20] ASTM A515 ⁴, *Standard Specification for Pressure Vessel Plates, Carbon Steel, for Intermediate- and Higher-Temperature Service*
- [21] ASTM C533, *Standard Specification for Calcium Silicate Block and Pipe Thermal Insulation*
- [22] ASTM C552, *Standard Specification for Cellular Glass Thermal Insulation*

¹ American Gas Association, 400 North Capitol St., NW, Suite 450, Washington, DC 20001, www.aga.org.

² American Industrial Hygiene Association, 3141 Fairview Park Drive, Suite 777, Falls Church, Virginia 22042, www.aiha.org.

³ American Society of Mechanical Engineers, Two Park Avenue, New York, New York 10016-5990, www.asme.org.

⁴ ASTM International, 100 Barr Harbor Drive, West Conshohocken, Pennsylvania 19428, www.astm.org.

- [23] ASTM C553, *Standard Specification for Mineral Fiber Blanket Thermal Insulation for Commercial and Industrial Applications*
- [24] ASTM C592, *Standard Specification for Mineral Fiber Blanket Insulation and Blanket-Type Pipe Insulation (Metal-Mesh Covered) (Industrial Type)*
- [25] ASTM C610, *Standard Specification for Molded Expanded Perlite Block and Pipe Thermal Insulation*
- [26] ASTM C612, *Standard Specification for Mineral Fiber Block and Board Thermal Insulation*
- [27] ASTM Data Series DS 11S1, *An Evaluation of the Elevated Temperature, Tensile, and Creep-Rupture Properties of Wrought Carbon Steel*, prepared for the Metals Properties Council by G. V. Smith
- [28] T. Abbasi and S.A. Abbasi, "Accidental Risk of Superheated Liquids and a Framework for Predicting the Superheat Limit," *Journal of Loss Prevention in the Process Industries*, Volume 20, 2007, pp. 165–181 [NOTE Table 1 values for T_c for methane, ethane, and propane should be 190K, 305K, and 369K, respectively.]
- [29] C. Anderson, W. Townsend, J. Zook, and G. Cowgill, *The Effects of a Fire Environment on a Rail Tank Car Filled With LPG*, FRA-OR&D Report Number 75-31, PB-241358, September 1974
- [30] Anonymous report to API Subcommittee on Pressure-Relieving Systems regarding a fire (not a test), June 1941
- [31] R. E. Apfel, "Water Superheated to 279.5°C at Atmospheric Pressure," *Nature*, Volume 238, July 24, 1972, pp. 63–64
- [32] C. Balke, W. Heller, R. Konersmann, and J. Ludwig, *Study of the Failure Limits of a Railway Tank Car Filled With Liquefied Petroleum Gas Subjected to an Open Pool Fire Test*, Federal Institute for Materials Research and Testing (BAM), Berlin, Test Report III.2/9907, September 13, 1999
- [33] C. E. Baukal, Jr. (Editor) and R. E. Schwartz (Associate Editor), *The John Zink Combustion Handbook*, CRC Press, Boca Raton, Florida, 2001, ISBN 0-8439-2337-1
- [34] C. L. Beyler, "Fire Hazard Calculations for Large, Open Hydrocarbon Fires," *The SFPE Handbook of Fire Protection Engineering*, Section 3, Chapter 11, Third Edition, 2002, National Fire Protection Association, Quincy, Massachusetts
- [35] J. P. Brill and H. D. Beggs, *Two-Phase Flow in Pipes*, Published by the University of Tulsa, Oklahoma, Sixth Edition, April 1994
- [36] T. A. Brzustowski and E. C. Sommer, Jr., "Predicting Radiant Heating from Flares," *API Proceedings*, Volume 53, 1973, pp. 865–893
- [37] J. K. J. Buettner, "Heat Transfer and Safe Exposure Time for Man in Extreme Thermal Environment," *ASME*, New York, 1957, Paper 57-SA-20
- [38] J. H. Burgoyne, "Mist and Spray Explosions," *Chemical Engineering Progress*, Volume 53, Number 3, 1957, pp. 121–124
- [39] C. Buxton, "Modulating PRV Performance Data," presentation to the Pressure Relieving Systems Committee at the Fall 2003 API Refining Meeting, September 17, 2003
- [40] CCPS⁵, *Guidelines for Engineering Design for Process Safety*, 1993, ISBN 0-8169-0565-7
- [41] CCPS, *Guidelines for Evaluating the Characteristics of Vapour Cloud Explosions, Flash Fires, and BLEVES*, 1994, ISBN 0-8169-0474-x

⁵ American Institute of Chemical Engineers, Center for Chemical Process Safety, 120 Wall Street, FI 23, New York, New York, 10005, www.aiche.org/ccps.

- [42] CCPS, *Guidelines for Pressure Relief and Effluent Handling Systems*, 1998, ISBN 0-8169-0476-6
- [43] CCPS, *Guidelines for Pressure Relief and Effluent Handling Systems*, 2017, ISBN 978-0-470-76773-3
- [44] CCPS, *Guidelines for Safe Automation of Chemical Processes*, 1993, ISBN 0-8169-0554-1
- [45] CCPS, *Layer of Protection Analysis: A Simplified Process Risk Assessment*, 2001, ISBN 0-8169-0811-7
- [46] Chemetron Corporation, *Tube-Turn Catalogue and Engineering Data Book No. 211*, Louisville, Kentucky
- [47] L. D. Cleveland, "How to Design and Operate Refinery Flares," *Oil and Gas Journal*, Volume 50, August 4, 1952, pp. 72–76, 94–95
- [48] CONCAWE, *Acoustic Fatigue in Pipes*, CONCAWE Report 85/52 (1985)
- [49] J. Cowling, "Design Strategies for Acoustically Induced Vibration in Process Piping," *InterNoise12*, 2012, pp. 1239–1248, Institute of Noise Control Engineering of the USA (INCE/USA)
- [50] Crane Engineering Division, *Flow of Fluids Through Valves, Fittings, and Pipe*, Technical Paper 410
- [51] J. A. Dean (Editor), *Lange's Handbook of Chemistry*, 12th Edition, ISBN 0-07-016191-7, 1979
- [52] DIN V 19250, *Control Technology; Fundamental Safety Aspects to Be Considered for Measurement and Control Equipment*, Deutsches Institut für Normung e. V. (German Institute for Standardization), Berlin
- [53] J. J. Duggan, C. H. Gilmour, and P. F. Fisher, "Requirements for Relief of Overpressure in Vessels Exposed to Fire," *Transactions of the ASME*, Volume 66, 1944, pp. 1–53
- [54] F. G. Eichel, "Electrostatics," *Chemical Engineering*, Volume 74, March 13, 1967, pp. 153–167
- [55] Energy Institute ⁶, *Guidelines for the avoidance of vibration induced fatigue in process pipework*, Second Edition, 2008, ISBN 978-0-85293-463-0
- [56] Energy Institute, *Guidelines for the design and protection of pressure systems to withstand severe fires*, 2003, ISBN 0-85293-279-0
- [57] Energy Institute, *Guidelines for the design and safe operation of shell and tube heat exchangers to withstand the impact of tube failure*, 2000, ISBN 0-85293-286-3
- [58] U.S. EPA 40 *Code of Federal Regulations (CFR) 60.18* ⁷, *General Control Device Requirements*
- [59] U.S. EPA-600/2-83-052, *Flare Efficiency Study*, M. McDaniel, July 1983 (PB83-261644)
- [60] U.S. EPA-600/2-86-080, *Evaluation of the Efficiency of Industrial Flares: H₂S Gas Mixtures and Pilot Assisted Flares*, September 1986
- [61] U.S. EPA, *Acute Exposure Guideline Levels (AEGLs)*
- [62] European Commission, *Classification of Hazardous Substances and Preparations*, Directive 2001/59/EC
- [63] N. Faulk and A. Aldeeb, "Understanding Gas Blowby Scenario Calculations," *Proceedings of the 11th Global Congress on Process Safety*, American Institute of Chemical Engineers, Austin, Texas, 2015
- [64] Fire and Blast Information Group (FABIG), *Fire Loading and Structural Response*, Technical Note 11, March 2010
- [65] H. K. Fauske, "Scale-up for Safety Relief of Runaway Reactions," *Plant/Operations Progress*, Volume 3, Number 1, 1984, pp. 7–11

⁶ Energy Institute, 61 New Cavendish Street, London W1G 7AR, United Kingdom, www.energyinst.org.

⁷ U.S. Environmental Protection Agency, 1200 Pennsylvania Avenue, NW, Washington, DC 20460, www.epa.gov.

- [66] H. K. Fauske et al., "Emergency Relief Vent Sizing for Fire Emergencies Involving Liquid Filled Atmospheric Storage Vessels," *Plant/Operations Progress*, Volume 5, Number 4, October 1986, pp. 205–208
- [67] H. G. Fisher, "An Overview of Emergency Relief System Design Practice," *Plant/Operations Progress*, Volume 10, Number 1, January 1991, pp. 1–12
- [68] H. G. Fisher and H. S. Forrest, "Protection of Storage Tanks from Two-Phase Flow Due to Fire Exposure," *Process Safety Progress*, Volume 14, No. 3, July 1995, pp. 183–199
- [69] H. G. Fisher et al., *Emergency Relief System Design Using DIERS Technology*, 1992, ISBN 0-8169-0568-1, published by the American Institute of Chemical Engineers, New York
- [70] H. S. Forrest, "Emergency Relief System Design for Fire Exposure with Consideration of Multiphase Flow," 1995 International Symposium on Runaway Reactions and Pressure Relief Design, ISBN 0-8169-0676-9, published by the American Institute of Chemical Engineers, pp. 604–630
- [71] D. W. Fowler, T. R. Herndon, and R. C. Wahrmund, "An Analysis of Potential Overpressure of Heat Exchanger Shell Due to a Ruptured Tube," paper presented at the ASME Petroleum Division Conference, September 22–25, 1968
- [72] J. O. Francis and W. E. Shackelton, "A Calculation of Relieving Requirements in the Critical Region," API Proceedings, Volume 64, 1985, pp. 179–182
- [73] P. A. Franken, "Jet Noise," Chapter 24, pp. 644–666 of *Noise Reduction*, edited by L. L. Beranek, McGraw Hill Book Company, 1960
- [74] F. A. Gifford, Jr., "Atmospheric Dispersion Calculations Using the Generalized Garrison Plume Model," *Nuclear Safety*, December 1960, pp. 56–59
- [75] M. A. Grolmes, J. C. Leung, and H. K. Fauske, *Reactive Systems Vent Sizing Evaluations International Symposium on Runaway Reactions*, ISBN 0-8169-0460-X, 1989, pp. 451–476
- [76] J. D. Hajek and E. E. Ludwig, "How to Design Safe Flare Stacks, Part 1," *Petro/Chem Engineer*, 1960, Volume 32, Number 6, pp. C31–C38; "Part 2," *Petro/Chem Engineer*, 1960, Volume 32, Number 7, pp. C44–C51
- [77] T. Z. Harmathy and L. W. Allen, "Thermal Properties of Selected Masonry Unit Concretes," Title Number 70-15, *ACI Journal*, February 1973
- [78] [UK] Health and Safety Executive, *Testing and Analysis of Relief Device Opening Times*, Offshore Technology Report 2002/023, ISBN 0717623610
- [79] I. Heitner, T. Trautmauis, and M. Morrissey, "Relieving Requirements for Gas Filled Vessels Exposed to Fire," API Proceedings, Volume 62, 1983, pp. 112–122, and *Hydrocarbon Processing*, November 1983, pp. 263–268
- [80] F. J. Heller, "Safety Relief Valve Sizing: API versus CGA Requirements Plus a New Concept for Tank Cars," API Proceedings, Volume 62, 1983, pp. 123–135
- [81] R. E. Henry and H. K. Fauske, "The Two Phase Critical Flow of One Component Mixtures in Nozzles, Orifices, and Short Tubes," *Journal of Heat Transfer*, May 1971, pp. 179–187
- [82] V. O. Hoehne, R. G. Luce, and L. W. Miga, "The Effect of Velocity, Temperature, and Gas Molecular Weight on Flammability Limits in Wind-Blown Jets of Hydrocarbon Gases," report to the American Petroleum Institute, Battelle Memorial Institute, Columbus, Ohio, 1970, and API Proceedings, Volume 50, 1970, pp. 1057–1081
- [83] H. C. Hottel, private communication to API Subcommittee on Pressure-Relieving Systems, January 1948

- [84] H. C. Hottel, private communication to API Subcommittee on Pressure-Relieving Systems, December 1950
- [85] HS025—*Fire & Explosion Guidance*, published by Oil and Gas UK Co., 2007 (Update of *Fire and explosion guidance, Part 2: Avoidance and mitigation of fires*, Doc. 152-RP-48, Fireandblast.com, which is no longer available)
- [86] J. E. Huff and K. R. Shaw, "Measurement of Flow Resistance of Rupture Disc Devices," *Plant/Operations Progress*, Volume 11, Number 3, July 1992, pp. 187–200
- [87] H. W. Husa, "How to Compute Safe Purge Rates," *Hydrocarbon Processing and Petroleum Refiner*, Volume 43, Number 5, 1964, pp. 179–182
- [88] IEC 61508 (all parts) ⁸, *Functional safety of electrical/electronic/programmable electronic safety-related systems*
- [89] IEC 61511 (all parts), *Functional safety—Safety instrumented systems for the process industry sector*
- [90] *InterNoise12*, Flow Induced Noise and Vibration program consisting of 26 papers, August 19–22, 2012, New York, available from Institute of Noise Control Engineering of the USA (INCE/USA)
- [91] ISA 84.01 ⁹, *Application of Safety Instrumented Systems for the Process Industries*
- [92] ISA TR84.02, *Functional Safety: Safety Instrumented Systems for the Process Industry Sector—Part 2: Guidelines for the Application of ANSI/ISA-84.00.01-2004, IEC 61511-2 Mod*
- [93] ISO/TR 10400:2007 ¹⁰, *Petroleum and natural gas industries—Equations and calculations for the properties of casing, tubing, drill pipe and line pipe used as casing or tubing*
- [94] D. W. Johnson and J. L. Woodward, *Release, a Model with Data to Predict Aerosol Rainout in Accidental Releases*, published by Center for Chemical Process Safety, ISBN 0-8169-0745-5
- [95] H. H. Jones, "American Conference of Governmental Industrial Hygienists' Proposed Threshold Limit Value for Noise," *American Industrial Hygiene Association Journal*, Volume 29, Number 6, November/December 1968, pp. 537–540
- [96] P. Kandell, "Program Sizes Pipe and Flare Manifolds for Compressible Flow," *Chemical Engineering*, Volume 88, June 29, 1981, pp. 89–93
- [97] G. C. Karcher, *Pressure Changes in Liquid Filled Vessels or Piping Due to Temperature Changes*, ExxonMobil Research and Engineering Mechanical Newsletter EE.84E.76, August 1976
- [98] G. R. Kent, "Practical Design of Flare Stacks," *Hydrocarbon Processing and Petroleum Refiner*, Volume 43, Number 8, 1964, pp. 121–125
- [99] K. A. Kimberly A. and A. E. Summers, "Are Your Instrumented Safety Systems Up to Standard?" *Chemical Engineering Progress*, Volume 94, Number 11, November 1998, pp. 55–58
- [100] D. M. Kirkpatrick, "Simpler Sizing of Gas Piping," *Hydrocarbon Processing*, Volume 48, Number 12, December 1969, pp. 135–138
- [101] J. Lamar, "SRU Overpressure in a Waste Heat Boiler Failure," Brimstone STS Limited Symposium, September 2005
- [102] J. Lamar, "SRU Overpressure in a Waste Heat Boiler Failure," Brimstone STS Limited Symposium, September 2011

⁸ International Electrotechnical Commission, 3 Rue de Varembe, PO Box 131, CH-1211 Geneva 20, Switzerland, www.iec.ch.

⁹ International Society of Automation, 67 T.W. Alexander Drive, Research Triangle Park, North Carolina 27709, www.isa.org.

¹⁰ International Organization for Standardization, Chemin de Blandonnet 8, CP 401, 1214 Vernier, Geneva, Switzerland, www.iso.org.

- [103] C. E. Lapple, "Isothermal and Adiabatic Flow of Compressible Fluids," *Transactions of the American Institute of Chemical Engineers*, Volume 39, 1943, pp. 385–432
- [104] F. P. Lees, "Lees' Loss Prevention in the Process Industries. Hazard Identification, Assessment and Control" 4th Edition, 2012, ISBN: 9780123971890, Published by Butterworth-Heinemann
- [105] J. Lenclud and J. Venard, "Single and two-phase discharge from a pressurized vessel," *Rev Gén Therm* Volume 35, 1996, pp. 503–516
- [106] J. C. Leung, "Overpressure During Emergency Relief Venting in Bubbly and Churn Turbulent Flow," *AIChE Journal*, Volume 33, Number 6, June 1987, pp. 952–958
- [107] J. C. Leung, "Simplified Vent Sizing Equations for Emergency Relief Requirements in Reactors and Storage Vessels," *AIChE Journal*, Volume 32, Number 10, October 1986, pp. 1622–1634
- [108] J. C. Leung, "Size Safety Relief Valves for Flashing Liquids," *Chemical Engineering Progress*, Volume 88, Number 2, February 1992, pp. 70–75
- [109] J. C. Leung and M. A. Grolmes, "The Discharge of Two-Phase Flashing Flow in a Horizontal Duct," *AIChE Journal*, Volume 33, No. 3, March 1987, pp. 524–527
- [110] J. C. Leung and F. N. Nazario, "Two-Phase Flashing Flow Methods and Comparison," *Journal of Loss Prevention Process Industries*, Volume 3, Number 2, 1990, pp. 253–260
- [111] D. E. Loudon, "Requirements for Safe Discharge of Hydrocarbons to Atmosphere," *API Proceedings*, Volume 43, 1963, pp. 418–433
- [112] J. Ludwig and W. Heller, *Fire Test With a Propane Tank Car*, Federal Institute for Materials Research and Testing (BAM), Berlin, Test Report III.2/9907, 1999
- [113] H. Y. Mak, "New Method Speeds Pressure-Relief Manifold Design," *Oil and Gas Journal*, Volume 76, November 20, 1978, pp. 167–172
- [114] F. L. Maker, private communication to API Subcommittee on Pressure-Relieving Systems, regarding 1925 tests, December 22, 1950
- [115] J. A. Mann, D. Eilers, and A. C. Fagerlund, "Predicting Pipe Internal Sound Field and Pipe Wall Vibration Using Statistical Energy Approaches for AIV," *Inter-Noise 2012*, August 2012
- [116] [UK] Marine Technology Directorate (MTD), *Guidelines for Avoidance of Vibration Induced Fatigue in Process Pipework*, MTD Publication 99/100, ISBN 1-870553-37-3, 1999
- [117] D. Martens, "Tube and Tube Weld Corrosion and Tube Collapse," *Brimstone STS Limited Symposium* September 2011
- [118] S. McGuffie, M. Porter, D. Martens, and M. Demskie, "Combining CFD Derived Information and Thermodynamic Analyses to Investigate Waste Heat Boiler Characteristics," *ASME PVP 2011 Conference*, paper number 57625
- [119] G. Melhem, M. Brewer, and M. Porter, "The Anatomy of Liquid Displacement and Vapor Breakthrough," *Proceedings of the 12th Global Congress on Process Safety*, Houston, Texas, 2016, American Institute of Chemical Engineers
- [120] D. F. Montague and J. J. Rooney, *Trade-off Risks: Addressing the Tension between Reliability and Safety*, International Conference and Workshop on Reliability and Risk Management, San Antonio, Texas, 1998
- [121] M. D. Moosemiller and W. H. Brown, *Finding an Appropriate Level of Safeguards*, International Conference and Workshop on Risk Analysis in Process Safety, Atlanta, GA, 1997
- [122] H. Mott and B. Sparrow, *A Simple Relief Valve Rating/Sizing Method for Fire Relief from Liquid-filled Vessels*, presentation to API RP-521 Subcommittee, September 30, 2002

- [123] NASA ¹¹, *Toroidal Ring Prevents Gas Ignition at Vent Stack Outlet*, Technical Brief 67-10098, 1967
- [124] NFPA 15 ¹², *Standard for Water Spray Fixed Systems for Fire Protection*
- [125] NFPA 68, *Guide for Venting of Deflagration*
- [126] NFPA 69, *Explosion Prevention Systems*
- [127] NFPA 780, *Standard for the Installation of Lightning Protection Systems*
- [128] NFPA HAZ01, *Fire Protection Guide to Hazardous Materials*
- [129] M. Nishiguchi, H. Izuchi, I. Hayashi, and G. Minorikawa, "Flow Induced Vibration of Piping Downstream of Tee Connection," Proceedings—10th International Conference on Flow-Induced Vibration and Flow Induced Noise (FIV 2012), July 2012, pp. 523–530
- [130] M. Nishiguchi, H. Izuchi, I. Hayashi, and G. Minorikawa, "Investigation of Characteristic of Flow Induced Vibration Caused by Turbulence Relating to Acoustically Induced Vibration," Proceedings—ASME 2014 Pressure Vessels and Piping Conference PVP2014, Volume 3: Design and Analysis, July 20–24, 2014, Paper No: PVP2014-28600
- [131] R. K. Noble, M. R. Keller, and R. E. Schwartz, "An Experimental Analysis of Flame Stability of Open Air Diffusion Flames," *American Flame Research Committee 1984 International Symposium on Alternative Fuels and Hazardous Wastes*, October 1984
- [132] Oil Companies International Marine Forum, *ISGINTT, International Safety Guide for Inland Navigation Tank-barges and Terminals*, First Edition, 2010
- [133] OSHA 29 CFR 1910.119 ¹³, *Process Safety Management of Highly Hazardous Chemicals*
- [134] S. J. Overaa, E. Stange, and P. Salater, *Determination of Temperatures and Flare Rates During Depressurization and Fire*, paper presented at 72nd annual Gas Processors Association (GPA) Convention, San Antonio, Texas, 1993
- [135] C. F. Parry, *Relief Systems Handbook*, Institution of Chemical Engineers, Rugby, Warwickshire, United Kingdom, ISBN 0-85295-267-8, 1992
- [136] R. H. Perry, D. W. Green, and J. O. Maloney (Editors), *Perry's Chemical Engineers' Handbook*, Seventh Edition, pp. 6–25 (ISBN 0-07-049841-5, 1999); Sixth Edition (ISBN 0-07-049479-7, 1984); and Fifth Edition (ISBN 0-07-049478-9, 1973)
- [137] M. Porter, D. Martens, T. Duffy, and S. McGuffie, "Computational Fluid Dynamics Investigation of a High Temperature Waste Heat Exchanger Tube Sheet Assembly," Proceedings—ASME 2005 Pressure Vessels & Piping Conference, paper number 71143
- [138] M. Porter, D. Martens, S. McGuffie, and J. Wheeler, "A Means for Avoiding Sulfur Recovery Reaction Furnace Fired Tube Boiler Failures," ASME PVP 2009 Conference paper number 78073
- [139] R. D. Reed, "Design and Operation of Flare Systems," *Chemical Engineering Progress*, Volume 64, Number 6, June 1968, pp. 53–57
- [140] R. D. Reed, "Oil Droplets Cause Gas-Burner Problems," *Oil and Gas Journal*, Volume 77, December 3, 1979, pp. 80–81

¹¹ National Aeronautics and Space Administration, 300 E. Street SW, Suite 5R30, Washington, DC 20546, www.nasa.gov.

¹² National Fire Protection Association, 1 Batterymarch Park, Quincy, Massachusetts 02169, www.nfpa.org.

¹³ U.S. Department of Labor, Occupational Safety and Health Administration, 200 Constitution Avenue, NW, Washington, DC 20210, www.osha.gov.

- [141] R. Reid, "Rapid phase transitions from liquid to vapor", *Advances in Chemical Engineering*, Volume 12, 1983, pp. 105–208
- [142] F. P. Ricou and D. B. Spalding, "Measurement of Entrainment by Axisymmetrical Turbulent Jets," *Journal of Fluid Mechanics*, Volume 11, 1961, pp. 21–32
- [143] Rubber Reserve Corporation, *Heat Input to Vessels*, Safety Memorandum 89, Washington, DC, May 1944
- [144] P. Salater, S. J. Overaa, and E. Kjensjord, "Size Depressurization and Relief Devices for Pressurized Segments Exposed to Fire," *Chemical Engineering Progress*, Volume 98, Number 9, 2002, pp. 38–45
- [145] P. Salater and S. J. Overaa, *Pipes Exposed to Medium Sized Jet Fires—Rupture Conditions and Models for Predicting Time to Rupture*, presented at FABIG (Fire and Blast Information Group), London and Aberdeen, January 2004
- [146] D. I. Saletan, "The Theory Behind Static Electricity Hazards in Process Plants," *Chemical Engineering*, Volume 66, Number 1, 1959, pp. 99–102
- [147] R. E. Sanders, *Chemical Process Safety*, published by Butterworth-Heinemann, pp. 21–34, pp. 54–57, ISBN 0-7506-7749-X
- [148] Scandpower, *Guidelines for the Protection of Pressurised Systems Exposed to Fire*, Report 27.207.291/R1, Version 2, March 31, 2004
- [149] A. D. Scheiman, "How to Size Shower Deck Baffled Towers Quicker: Part 1—Tower Diameter," *Petro/Chem Engineer*, Volume 37, Number 3, 1965, pp. 28–33 and "How to Size Shower Deck Baffled Towers Quicker: Part 2—Tower Tangent Length," *Petro/Chem Engineer*, Volume 37, Number 4, 1965, pp. 75, 78–79
- [150] R. E. Schwartz and S. G. Kang, "Effective Design of Emergency Flaring Systems," *Hydrocarbon Engineering*, February 1998, pp. 57–62
- [151] R. E. Schwartz and M. Keller, "Environmental Factors versus Flare Application," 11th Loss Prevention Symposium, Houston, Texas, March 22, 1977, Paper 13d, published by American Institute of Chemical Engineers
- [152] R. E. Schwartz and M. Keller, "Flaring in Hostile Environments," paper presented at a Seminar on Flare Systems arranged by the Norwegian Society of Chartered Engineers, 1982
- [153] R. E. Schwartz and J. W. White, "Predict Radiation from Flares," *Chemical Engineering Progress*, Volume 93, Number 7, July 1997, pp. 42–49
- [154] J. G. Seebold, "Pulsating Combustion in Elevated Flares Caused by Seal Drum Sloshing," *Noise Control Engineering*, Volume 3, Number 1, July/August 1974, pp.14–17
- [155] L. L. Simpson, "Estimate Two-Phase Flow in Safety Devices," *Chemical Engineering*, Volume 98, Number 8, August 1991, pp. 98–102
- [156] L. L. Simpson, "Fire Exposure of Liquid-Filled Vessels," 29th DIERS Users Group Meeting, Las Vegas, Nevada, April 29 to May 1, 2002, paper D29-190-1
- [157] A. M. Stoll and L. C. Green, "The Production of Burns by Thermal Radiation of Medium Intensity," 1958, Paper 58-A-219, American Society of Mechanical Engineers, New York
- [158] V. H. Sumaria, J. A. Rovnak, I. Heitner, and R. J. Herbert, "Model to Predict Transient Consequences of a Heat Exchanger Tube Rupture," *API Proceedings*, Volume 55, 1976, pp. 631–654
- [159] N. E. Sylvander and D. L. Katz, *Investigation of Pressure Relieving Systems*, Engineering Research Bulletin 31, University of Michigan, Ann Arbor, April 1948

- [160] S. H. Tan, "Flare System Design Simplified," *Hydrocarbon Processing and Petroleum Refiner*, Volume 46, Number 1, 1967, pp. 172–176
- [161] J. F. Taylor, H. L. Grimmer, and E. C. Comings, "Isothermal Free Jets of Air Mixing with Air," *Chemical Engineering Progress*, Volume 47, 1951, pp. 175–180
- [162] Underwriters Laboratory, Inc., *Opacity of Water to Radiant Heat Energy*, Research Bulletin 3, Northbrook, Illinois, 1938
- [163] University of Michigan, unpublished tests made for API Subcommittee on Pressure-Relieving Systems, June 1947
- [164] H. R. Wharton, *Digest of Steels for High-Temperature Service*, Timken Steel, 1946
- [165] W. Y. Wong, "PRV Sizing for Heat Exchanger Tube Rupture," *Hydrocarbon Processing*, Volume 71(2), February 1992, pp. 59–64
- [166] J. W. Young et al., *Electrostatic and Gas Blowout*, Canadian Mining Meeting Bulletin 63, 1960, p. 456 and *Metallurgical Bulletin*, Volume 53, Number 581, September 1960, pp. 682–686
- [167] M. G. Zabetakis, *Flammability Characteristics of Combustible Gases and Vapors*, U.S. Bureau of Mines Bulletin 627, 1965
- [168] M. G. Zabetakis and D. S. Burgess, *Research on the Hazards Associated with the Production and Handling of Liquid Hydrogen*, U.S. Bureau of Mines Report of Investigation 5707, 1961

The following documents are not directly referenced in this standard but provide a useful source of relevant information.

Disposal Systems

- [169] G. Armistead, Jr., *Safety in Petroleum Refining and Related Industries*, Second Edition, John G. Simmonds, New York, 1959
- [170] C. H. Bosanquet, W. F. Carey, and F. M. Halton, *Journal of the Institution of Mechanical Engineers*, Volume 162, Number 3, London, 1950, p. 355
- [171] R. M. Fristrom, *Chemical and Engineering News*, Volume 41, Number 41, October 14, 1963, pp. 150–160
- [172] R. L. Gordier, *Studies on Fluid Jets Discharging Normally Into Moving Liquid*, Technical Paper Number 28, Series B. St. Anthony Falls Hyd. Lab., University of Minnesota, 1959
- [173] B. Karlovitz, *Chemical Engineering Progress*, Volume 61, Number 8, 1965, pp. 56–62
- [174] W. R. Keagy and A. E. Weller, *A Study of Freely Expanding Inhomogeneous Jets*, paper number 89, Heat Transfer and Fluid Mechanics Institute, University of California, Berkeley, 1949
- [175] J. F. Keffer and W. D. Baines, *Journal of Fluid Mechanics*, Volume 15, 1963, p. 487
- [176] *Manual on Disposal of Refinery Wastes—Volume on Atmospheric Emissions*, API, Washington, DC, 1977
- [177] P. D. Miller, Jr., H. J. Hibshman, and J. R. Connell, *API Proceedings*, Volume 38, API, Washington, DC, 1958, pp. 276–281
- [178] O. A. Pipkin and C. M. Sliepcevich, *Industrial and Engineering Chemistry Fundamentals*, Volume 3, Number 2, 1964, pp. 147–154
- [179] K. Wohl, N. M. Kapp, and C. Gazley, *Proceedings: 3rd Symposium (International) on Combustion and Flame Explosion Phenomena*, Madison, Wisconsin, 1948, Williams and Wilkins, Baltimore, 1949, pp. 321

Drums and Separators

- [180] G. D. Kerns, *Petroleum Refiner*, Volume 39, Number 7, 1960, pp. 168–170
- [181] E. J. Lapadula, *Chemical Engineering*, Volume 70, Number 16, August 5, 1963, pp. 128–129
- [182] C. F. Montross, *Chemical Engineering*, Volume 60, Number 10, 1953, pp. 213–236
- [183] F. R. Niemoyer, *Hydrocarbon Processing and Petroleum Refiner*, Volume 40, Number 6, 1961, pp. 155–156
- [184] A. D. Scheiman, *Hydrocarbon Processing and Petroleum Refiner*, Volume 42, Number 10, 1963, pp. 165–168
- [185] A. D. Scheiman, *Hydrocarbon Processing and Petroleum Refiner*, Volume 43, Number 5, 1964, pp. 155–160
- [186] V. Smith, *Oil and Gas Journal*, Volume 57, Number 1, 1959, pp. 97–101
- [187] R. N. Watkins, *Hydrocarbon Processing*, Volume 46, Number 11, 1967, pp. 253–256

Flares and Stacks

- [188] Anonymous, *Ringelmann Smoke Chart (Revision of IC 7718)*, U.S. Department of the Interior, Bureau of Mines, Information Circular 8333, 1967
- [189] M. Aslam, “How to Find...Minimum Length of Process Piping,” *Hydrocarbon Processing*, November 1970, pp. 203–208
- [190] K. Banerjee, N. P. Cheremisinoff, and P. N. Cheremisinoff, *Flare Gas Systems Pocket Handbook*, Gulf Publishing Company, Houston, Texas, 1985, ISBN 0-87201-310-3
- [191] E. D. Bergman, “The Design of Vertical Pressure Vessels Subjected to Applied Forces,” ASME Paper 54-A-104, *Transactions of the ASME*, August 1955, p. 863–866
- [192] P. P. Bijlaard, “Stresses from Radial Loads and External Moments in Cylindrical Pressure Vessels,” *Welding Journal*
- [193] R. G. Blick, “How to Calculate Wind-Caused Sway on Slender Columns,” *Petroleum Refiner*, Volume 37, Number 11, November 1958, pp. 237–240
- [194] W. C. Bluhm, “Safe Operation of Refinery Flare Systems,” *API Proceedings*, Volume 41, API, Washington, DC, 1961
- [195] F. T. Bodurtha, *Chemical Engineering*, Volume 65, Number 25, December 15, 1958, pp. 177–180
- [196] F. T. Bodurtha, *The Behaviour of Dense Stack Gases*, paper presented at the meeting of the Air Pollution Control Association, New York, 1955
- [197] BS 2742C, *Ringelmann Chart*, British Standards Institution, London
- [198] BS 2742M, *Miniature Smoke Chart*, British Standards Institution, London
- [199] BS 2742:1969, *Notes on the Use of the Ringelmann and Miniature Smoke Charts*, British Standards Institution, London
- [200] A. A. Brown, “How to Design Pile-supported Foundations for Flare Stacks,” *Hydrocarbon Processing*, December 1969, pp. 139–146
- [201] G. A. Chamberlain, “Developments in Design Methods for Predicting Thermal Radiation From Flares,” *Chem Eng Res Des*, Volume 65, July 1987, pp. 299–309

- [202] CONCAWE, *The Calculation of Atmospheric Dispersion from a Stack*, CONCAWE, the Hague, the Netherlands, 1966
- [203] E. K. Daniels, J. R. Lutz, and L. A. Castler, *API Proceedings*, Volume 38, API, Washington, DC, 1958, pp. 291–292
- [204] C.E. Freese, “Vibration of Vertical Pressure Vessels,” *Journal of Engineering for Industry*, pp. 77–91, February 1959
- [205] *Gas Processors Suppliers Association Data Book*, Section 5, 10th Edition, Tulsa, Oklahoma, 1987
- [206] J. Grumer, A. Strasser, J. M. Singer, and P. M. Gussey, *Hydrogen Flare Stack Diffusion Flames, Low Flow Instability, Burning Rates, and Dilution Limits*, U.S. Bureau of Mines Preprint, ERC No. 4030, U.S. Department of the Interior, Washington, DC, 1968
- [207] J. R. Hannaman and A. J. Etingen, *Petroleum Processing*, March 1956, pp. 66–69
- [208] E. W. Hewson, *Transactions of the American Society of Mechanical Engineers*, Volume 77, Number 10, 1955, pp. 1163–1172
- [209] Hymes, Boydell, and Prescott, *Thermal Radiation: Physiological and Pathological Effects*, IChemE Major Hazards Monograph, 1996, ISBN 0-85295-328-3
- [210] J. H. Johnson, *Petroleum Refiner*, Volume 26, Number 6, 1947, p. 91
- [211] M. R. Keller and R. K. Noble, “RACT for VOC—A Burning Issue,” *Pollution Engineering*, July 1983
- [212] J. Keller, R. K. Noble, and M. R. Keller, *Determining Safe Levels of Thermal Radiation Exposure on Personnel*, presented at the 34th Annual Loss Prevention Symposium, AIChE National Meeting, March 6–8, 2000
- [213] G. R. Kent, *Hydrocarbon Processing*, Volume 47, Number 6, 1968, pp. 119–130
- [214] J. F. Kuong, “Find Wind-Caused Bending Moment on Tall Vessels by Nomograph,” *Hydrocarbon Processing*, June 1969, pp. 192–195
- [215] S. H. Kwon et al., “Improve Flare Management,” *Hydrocarbon Processing*, July 1997
- [216] P. D. Miller, Jr., H. J. Hibschman, and J. R. Connell, *API Proceedings*, Volume 38, API, Washington, DC, 1958, pp. 276–281
- [217] G. B. Moody, “Mechanical Design of a Tall Stack,” *Hydrocarbon Processing*, September 1969, pp. 173–178
- [218] J. H. Pohl, *Combustion Efficiency of Flares*, U.S. Environmental Protection Agency, Research Triangle Park, NC, 1985
- [219] R. D. Reed, *Chemical Engineering Progress*, Volume 64, Number 6, June 1968, pp. 53–57
- [220] R. D. Reed, *Furnace Operations*, Third Edition, Gulf Publishing Company, Houston, Texas, 1981, ISBN 0-87201-301-4
- [221] R. R. Romano, “Control Emissions with Flare Efficiency,” *Hydrocarbon Processing*, October 1983
- [222] “Session on Refinery Flare Design,” *API Proceedings*, Volume 32M, API, Washington, DC, 1952, pp. 143–164
- [223] R. H. Sherlock and E. J. Leshner, *Transactions of the American Society of Mechanical Engineers*, Volume 77, Number 1, 1955, pp. 19
- [224] W. R. Smith, *Petroleum Processing*, June 1954, pp. 867–880

- [225] W. H. Smolen, *Petroleum Processing*, Volume 6, Number 9, 1951, pp. 978–982
- [226] E. J. Stankiewicz, *Combustion*, Volume 26, Number 8, February 1955, pp. 51–55
- [227] R. S. Steinbock, *Chemical Engineering*, Volume 59, Number 2, 1952, pp. 202–203
- [228] R. S. Steinbock, *Chemical Engineering*, Volume 59, Number 3, 1952, pp. 144–147
- [229] R. S. Steinbock, *Chemical Engineering*, Volume 59, Number 4, 1952, pp. 154–155
- [230] J. F. Straitz III, “Improved Flare Design,” *Hydrocarbon Processing*, October 1994
- [231] U.S. Environmental Protection Agency, *Compilation of Air Pollutant Emissions Factors*, Vol. 1, *Stationary Point and Area Sources*, AP-42, Fourth Edition, 1985 and Supplement F: Section 11.5, 9/91, “Industrial Flares”
- [232] W. R. Wichmann, A. G. Hopper, and J. L. Mershon, *Local Stresses in Spherical and Cylindrical Shells due to External Loadings*, Welding Research Council
- [233] A. Youness, “New Approach to Tower Deflection,” *Hydrocarbon Processing*, June 1969, pp. 121–126
- [234] J. Wilkins, et al., *The Design, Development and Performance of Indair and Mardair Flares*, Paper 2822, Offshore Technology Conference, May 2–5, 1977, Houston, Texas

Flashing Flow in Pipes

- [235] R. J. Anderson and T. W. F. Russell, *Chemical Engineering*, Volume 72, Number 25, December 6, 1965, pp. 139–144
- [236] R. J. Anderson and T. W. F. Russell, *Chemical Engineering*, Volume 72, Number 26, December 20, 1965, pp. 99–104
- [237] R. J. Anderson and T. W. F. Russell, *Chemical Engineering*, Volume 73, Number 1, January 3, 1966, pp. 87–90
- [238] O. Baker, *Oil and Gas Journal*, Volume 53, Number 12, July 26, 1954, pp. 185–190, 192, 195
- [239] O. Baker, *Oil and Gas Journal*, Volume 56, Number 45, November 10, 1958, pp. 156–157, 159–161, 163, 165, 167
- [240] O. Baker et al., AGA/API Report NX-28, October 1970
- [241] J. A. Chavez, *Oil and Gas Journal*, Volume 57, Number 35, August 24, 1959, pp. 100–102
- [242] J. M. Chenoweth and M. W. Martin, *Petroleum Refiner*, Volume 34, Number 10, 1955, pp. 151–155
- [243] J. Coates and B. S. Pressburg, *Chemical Engineering*, Volume 66, Number 18, September 7, 1959, pp. 153–154
- [244] A. E. Dukler, M. Wicks III, and R. G. Cleveland, *American Institute of Chemical Engineers Journal*, Volume 10, Number 1, 1964, pp. 38–51
- [245] K. E. First and J. E. Huff, *Design Charts for Two-Phase Flashing Flow in Emergency Pressure Relief Systems*, paper presented at AIChE International Symposium on Runaway Reactions, March 7–9, 1989
- [246] O. Flanigan, *Oil and Gas Journal*, Volume 56, Number 10, March 10, 1958, pp. 132–133, 136, 140–141
- [247] O. Flanigan, *Oil and Gas Journal*, Volume 57, Number 49, November 30, 1959, pp. 60–66
- [248] J. C. Leung, “A Generalized Correlation for One-Component Homogeneous Equilibrium Flashing Choked Flow,” *AIChE Journal*, Volume 32, Number 10, October 1986

- [249] R. W. Lockhart and R. C. Martinelli, *Chemical Engineering Progress*, Volume 45, Number 1, 1949, pp. 39–48
- [250] P. M. Paige, *Chemical Engineering*, Volume 74, Number 17, August 14, 1967, pp. 159–164
- [251] S. H. Richter, *Proceedings—Refining Department*, Volume 57, API, Washington, DC, 1978, pp. 23–35
- [252] N. C. J. Ros, *Journal of Petroleum Technology*, Volume 13, Number 10, 1961, pp. 1037–1049

Flashing Flow in Valves

- [253] H. D. Baumann, *The Introduction of a Critical Flow Factor for Valve Sizing*, Preprint T 34.3.62-1, paper presented at the 18th Annual Conference of the Instrument Society of America, Chicago, October 1962
- [254] L. R. Driskell, *Instrumentation Technology*, Volume 14, Number 6, 1967, pp. CVS1–CVS12
- [255] A. J. Hanssen, *Accurate Valve Sizing for Flashing Fluids*, Technical Bulletin Number 108, Conoflow Corp., 1964, Blackwood, New Jersey
- [256] G. R. Kent, *Control Engineering*, Volume 13, Number 5, 1966, pp. 87–92
- [257] G. R. Kent, *Control Engineering*, Volume 13, Number 6, 1966, pp. 69–73
- [258] C. W. Sheldon and C. B. Schuder, *Instruments and Control Systems*, Volume 38, Number 1, 1965, pp. 134–137

Piping

- [259] H. A. Altorfer, *Oil and Gas Journal*, Volume 53, Number 32, December 13, 1954, pp. 126–131
- [260] J. E. Conison, *Oil and Gas Journal*, Volume 52, Number 44, March 8, 1954, pp. 119–120
- [261] J. E. Conison, *Oil and Gas Journal*, Volume 52, Number 45, March 15, 1954, p. 115
- [262] J. E. Conison, *Oil and Gas Journal*, Volume 52, Number 47, March 29, 1954, p. 123
- [263] J. E. Conison, *Oil and Gas Journal*, Volume 52, Number 48, April 5, 1954, p. 123
- [264] L. R. Driskell, *Petroleum Refiner*, Volume 39, Number 7, 1960, pp. 127–132
- [265] F. Lipinski, *Oil and Gas Journal*, Volume 56, Number 14, April 14, 1958, p. 128
- [266] F. Lipinski, *Oil and Gas Journal*, Volume 56, Number 18, May 5, 1958, p. 129
- [267] F. Lipinski, *Oil and Gas Journal*, Volume 56, Number 20, May 19, 1958, p. 187
- [268] R. W. Missen, *Chemical Engineering*, Volume 69, Number 22, October 29, 1962, pp. 101–102
- [269] C. E. Parish and D. Cornell, *Petroleum Refiner*, Volume 34, Number 2, 1955, pp. 121–123
- [270] R. W. Roberts and D. Cornell, *Petroleum Refiner*, Volume 34, Number 7, 1955, pp. 141–143
- [271] N. Steshko, *Oil and Gas Journal*, Volume 54, Number 41, February 13, 1956, p. 141
- [272] N. Steshko, *Oil and Gas Journal*, Volume 54, Number 46, March 19, 1956, pp. 265–266
- [273] N. Steshko, *Oil and Gas Journal*, Volume 54, Number 47, March 26, 1956, p. 153
- [274] S. H. Tan, *Hydrocarbon Processing and Petroleum Refiner*, Volume 46, Number 10, 1967, pp. 149–154

Piping Guides and Anchors

- [275] J. E. Brock, *Heating, Piping and Air Conditioning*, Volume 36, Number 1, 1964, pp. 152–155
- [276] J. E. Brock, *Heating, Piping and Air Conditioning*, Volume 39, Number 1, 1967, pp. 144–147
- [277] C. S. Parker, *Heating, Piping and Air Conditioning*, Volume 39, Number 11, 1967, pp. 93–100

Pressure-relief Valves

- [278] C. S. Beard and F. D. Marton, *Regulators and Relief Valves*, Instrument Publishing Company, Pittsburgh, 1959, pp. 103–130
- [279] J. E. Bigham, *Chemical Engineering*, Volume 65, Number 3, February 10, 1958, pp. 133–136
- [280] J. E. Conison, *Petroleum Refiner*, Volume 34, Number 7, 1955, pp. 137–140
- [281] F. J. Heller, *Oil and Gas Journal*, Volume 52, Number 49, April 12, 1954, p. 159
- [282] F. J. Heller, *Oil and Gas Journal*, Volume 52, Number 52, May 3, 1954, p. 111
- [283] F. J. Heller, *Oil and Gas Journal*, Volume 53, Number 3, May 24, 1954, pp. 263–264
- [284] J. C. Leung and F. N. Nazario, *Two-Phase Flashing Flow Evaluations Based on DIERS, API, and ASME Methodologies*, paper presented at AIChE Loss Prevention Symposium, April 26, 1989
- [285] P. A. Puleo, *Petroleum Refiner*, Volume 39, Number 10, 1960, pp. 157–162
- [286] C. G. Weber, *Chemical Engineering*, Volume 62, Number 10, 1955, pp. 170–174
- [287] C. G. Weber, *Relief Valve Selecting and Sizing*, paper presented at the 7th Southeast Regional Instrument Society of America Conference, Charlotte, North Carolina, April 20, 1961
- [288] C. G. Weber, *Oil and Gas Equipment*, Volume 7, Number 11, September 1961, pp. 12–13

Rupture Disks

- [289] J. E. Bigham, *Chemical Engineering*, Volume 65, Number 7, April 7, 1958, pp. 143–145
- [290] W. J. Boyle, Jr., *Chemical Engineering Progress*, Volume 63, Number 8, 1967, pp. 61–66
- [291] J. F. W. Brown, *Transactions of the Institution of Chemical Engineers*, Volume 36, April 1958, London, pp. 81–86
- [292] E. Diss, H. Karma, and C. Jones, *Chemical Engineering*, Volume 68, Number 19, September 18, 1961, pp. 187–188
- [293] J. G. Lowenstein, *Chemical Engineering*, Volume 65, Number 1, January 13, 1958, pp. 157–158
- [294] J. A. Luker and M. J. Leibson, *Journal of Chemical and Engineering Data*, Volume 4, Number 2, April 1959, pp. 133–136
- [295] G. Monday, *Chemical Process Hazards with Special Reference to Plant Design*, Symp. Soc. Number 15, Volume 2, 1963, Institution of Chemical Engineers, London, p. 46
- [296] R. L. Solter, L. L. Fike, and F. A. Hansen, *API Proceedings*, Volume 43, API, Washington, DC, 1963, pp. 448–456
- [297] T. S. Murphy, *Chemical and Metallurgical Engineering*, Volume 51, November 1944, pp. 108–112
- [298] T. S. Murphy, *Chemical and Metallurgical Engineering*, Volume 51, December 1944, pp. 99–104

- [299] J. A. Weil, *Transactions of the American Society of Mechanical Engineers, Series E: Journal of Applied Mechanics*, Volume 81, Number 4, December 1959, pp. 621–624
- [300] H. R. Wright, *Transactions of the Institution of Chemical Engineers*, Volume 36, April 1958, London, pp. 69–78

Surge and Pressure Transients

- [301] L. Bergeron, *Water Hammer in Hydraulics and Wave Surges in Electricity*, John Wiley & Sons, New York, 1961
- [302] R. R. Burnett, *Oil and Gas Journal*, Volume 58, Number 18, May 2, 1960, pp. 153–160
- [303] C. L. Coccio, *Combustion*, Volume 38, Number 8, February 1967, pp. 18–22
- [304] G. A. Lindberg, *Pipeline Engineer*, Volume 37, Number 3, 1965, pp. 132–135
- [305] W. T. Rouleau, *Transactions of the American Society of Mechanical Engineers, Series D: Journal of Basic Engineering*, Volume 82, Number 4, December 1960, pp. 912–920
- [306] I. M. Sarlat and T. L. Wilson, *Transactions of the American Society of Mechanical Engineers, Series D: Journal of Basic Engineering*, Volume 84, Number 3, September 1962, pp. 363–368
- [307] A. H. Shapiro, *Dynamics and Thermodynamics of Compressible Fluid Flow*, Volume 2, Chapter 24, Ronald Press, New York, 1953
- [308] C. W. Signor, *American Society of Heating, Refrigeration and Air Conditioning Engineers Journal*, Volume 2, Number 4, 1960, p. 69
- [309] J. F. Wilkinson, D. V. Holliday, and E. F. Batey, *Oil and Gas Journal*, Volume 63, Number 2, January 11, 1965, pp. 94–95

Systems

- [310] API Recommended Practice 554 (all parts), *Process Control Systems*
- [311] B. Block, *Chemical Engineering*, Volume 69, Number 2, January 22, 1962, pp. 111–118
- [312] P. P. M. Brown and D. W. France, “How to Protect Air Cooled Exchangers from Overpressure,” *Hydrocarbon Processing*, August 1975, pp. 103–106
- [313] R. C. Case, *Proceedings—Division of Refining*, Volume 50, API, Washington, DC, 1970, pp. 1082–1092
- [314] J. E. Conison, *API Proceedings*, Volume 43, API, Washington, DC, 1963, pp. 434–447
- [315] W. H. Doyle, *National Safety Congress Transactions*, Volume 5, pp. 30–34; Volume 19, pp. 25–29, 1964
- [316] *General American Tank Car Manual*, GATX, Chicago, 1961
- [317] *Plant and Design Safety*, CEP Reprint, American Institute of Chemical Engineers, New York, 1965
- [318] H. F. Rase and M. H. Barrow, *Project Engineering of Process Plants*, Chapter 24, Wiley & Sons, New York, 1957



AMERICAN PETROLEUM INSTITUTE

200 Massachusetts Avenue, NW
Suite 1100
Washington, DC 20001-5571
USA

202-682-8000

Additional copies are available online at www.api.org/pubs

Phone Orders: 1-800-854-7179 (Toll-free in the U.S. and Canada)
303-397-7956 (Local and International)

Fax Orders: 303-397-2740

Information about API publications, programs and services is available
on the web at www.api.org.

Product No. C52107